

2024

HIGH QUALITY MOTORCYCLE PARTS





Bonamici Racing components were used by ROKIT BMW Motorrad WorldSBK Team and Toprak Razgatlıoğlu for the victory of the 2024 Superbike world championship

TECHNICAL PARTNERSHIP

Moto2/Moto3 World Championship



LEOPARD
RACING

SNIPERS
TEAM

WorldSBK - WorldSSP



OFFICIAL
SPONSOR

ROKiT



BMW MOTORRAD
WorldSBK Team



ALTHEA
Racing

BSB British Superbike



Endurance World
Championship



BMW MOTORRAD
World Endurance Team

altus
racing

MotoAmerica

CIV

MESAROLI
RACING

National Trophy / CEV

PISTARO
PISTA RACING TEAM

We are the official supplier of important teams within the world of international competitions. Race tracks are the best test bench for our high performance components.

Siamo fornitori ufficiali di importanti Team nel mondo delle competizioni internazionali. I circuiti di gara sono il miglior banco prova per i nostri componenti ad alte prestazioni.

INDEX - INDICE

ABOUT US - CHI SIAMO	7
REARSETS - PEDANE	8
ENGINE PROTECTIONS - PROTEZIONI MOTORE	30
DASHBOARD PROTECTIONS - PROTEZIONI STRUMENTAZIONE	46
TOP TRIPLE CLAMP - PIASTRE DI STERZO SUPERIORI	50
LEVERS - LEVE	54
FULL CLUTCH LEVER - LEVE FRIZIONE COMPLETE	66
BRAKE LEVER WITH REMOTE ADJUSTER - LEVE FRENO CON REGISTRO REMOTO	68
REMOTE ADJUSTER - REGISTRO REMOTO	69
LEVER PROTECTIONS - PROTEZIONE LEVE	72
HANDLEBARS - SEMIMANUBRI	78
CHAIN ADJUSTER - TENDICATENA	82
OIL TANK - SERBATOI OLIO	84
SWINGARMS SPOOL - SUPPORTI CAVALLETTO	86
MIRROR BLOCKS - TAPPI SPECCHIETTO	90
OIL CAPS - TAPPI OLIO	92
TANK CAPS - TAPPO SERBATOIO	94
MERCHANDISING	98
MODELS - MODELLI	102

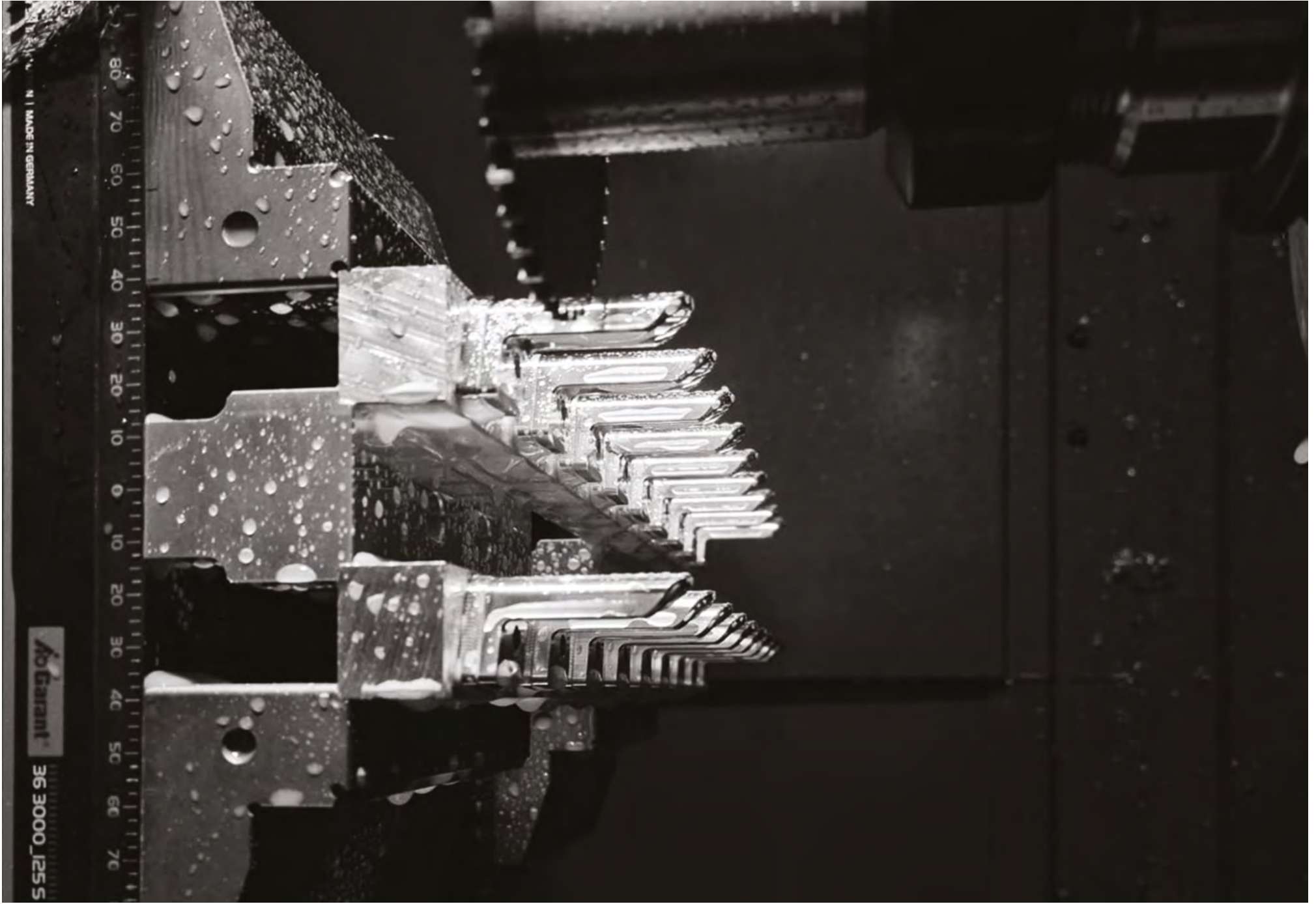



Design Progettazione

Every single detail of our products is the result of an accurate engineering design process, we develop the racing components that weigh no one gram more than necessary. The beauty of the lightness became tangible throughout the design, perspective and lines have been drawn to push over the performance.

Anche il più piccolo dettaglio dei nostri prodotti è il risultato di un accurato processo di progettazione, sviluppiamo componenti da competizione che non pesano un grammo più del necessario. La bellezza della leggerezza è resa tangibile attraverso il design, prospettiva e linee sono tracciate per andare oltre le prestazioni.



Production Realizzazione

We use the best technologies to produce the racing accessories with maximum care possible. By making a constant quality-oriented investments, by using of CNC machines and the best titanium, aluminum and steel alloys, we make high technology accessories to obtain the best performance during the race competitions.

Usiamo le migliori tecnologie per produrre accessori per moto in maniera accurata. Attraverso investimenti sulla qualità, l'uso di macchine a controllo numerico e le migliori leghe di titanio, alluminio e acciaio, produciamo accessori altamente performanti, in modo da ottenere il massimo delle prestazioni durante le competizioni motociclistiche.



Assistance Assistenza

We are ever ready to assist our customers and to provide them with the best solutions to optimize their mode to run the bike. We are able to develop new racing accessories and improve our products based on the reciprocal feedback. Our aftersales staff can solve any problems with maximum care and efficiency possible.

Siamo sempre pronti ad aiutare i nostri clienti per dargli le migliori soluzioni in grado di ottimizzare il loro modo di correre in moto. Siamo in grado di sviluppare nuovi accessori da corsa e migliorare i nostri prodotti attraverso il feedback costante tra noi ed i nostri clienti. Il nostro personale post-vendita è in grado di risolvere tutti i problemi con la massima cura ed efficienza possibile.



Tradition Tradizione

The Italian culture leads us to appreciate the beauty that is transmitted in all our products. We produce our accessories in Italy with the respect of Italian tradition. The history teaches us to create new items using the ingredients that brought Italy a fame in the field of race competitions.

La cultura italiana ci ha dato il senso del bello che noi trasmettiamo a tutti i nostri prodotti. Produciamo i nostri accessori in Italia con il rispetto della tradizione italiana, la storia ci insegna a fare nuovi oggetti, con tutti gli ingredienti che hanno reso l'Italia famosa nel mondo delle competizioni.

REARSETS - PEDANE

REARSETS TECHNICAL FEATURES

- High performance aluminum
- Double ball bearings
- Racing foot pegs with high grip
- Wide adjustment of the foot pegs position
- Hard anodic oxidation treatment
- Shift lever adjustable
- Break point of the foot pegs
- Non-slip rubber tip

REARSETS CARATTERISTICHE TECNICHE

- Alluminio ad alte prestazioni
- Doppi cuscinetti a sfera
- Poggiapiedi racing ad alto grip
- Regolazione della posizione del poggiapiedi
- Trattamento di ossidazione anodica dura
- Leva del cambio regolabile
- Punto di rottura del poggiapiedi
- Punta in gomma antiscivolo

BRAKE LEVER - LEVA FRENO

GEAR LEVER - LEVA CAMBIO

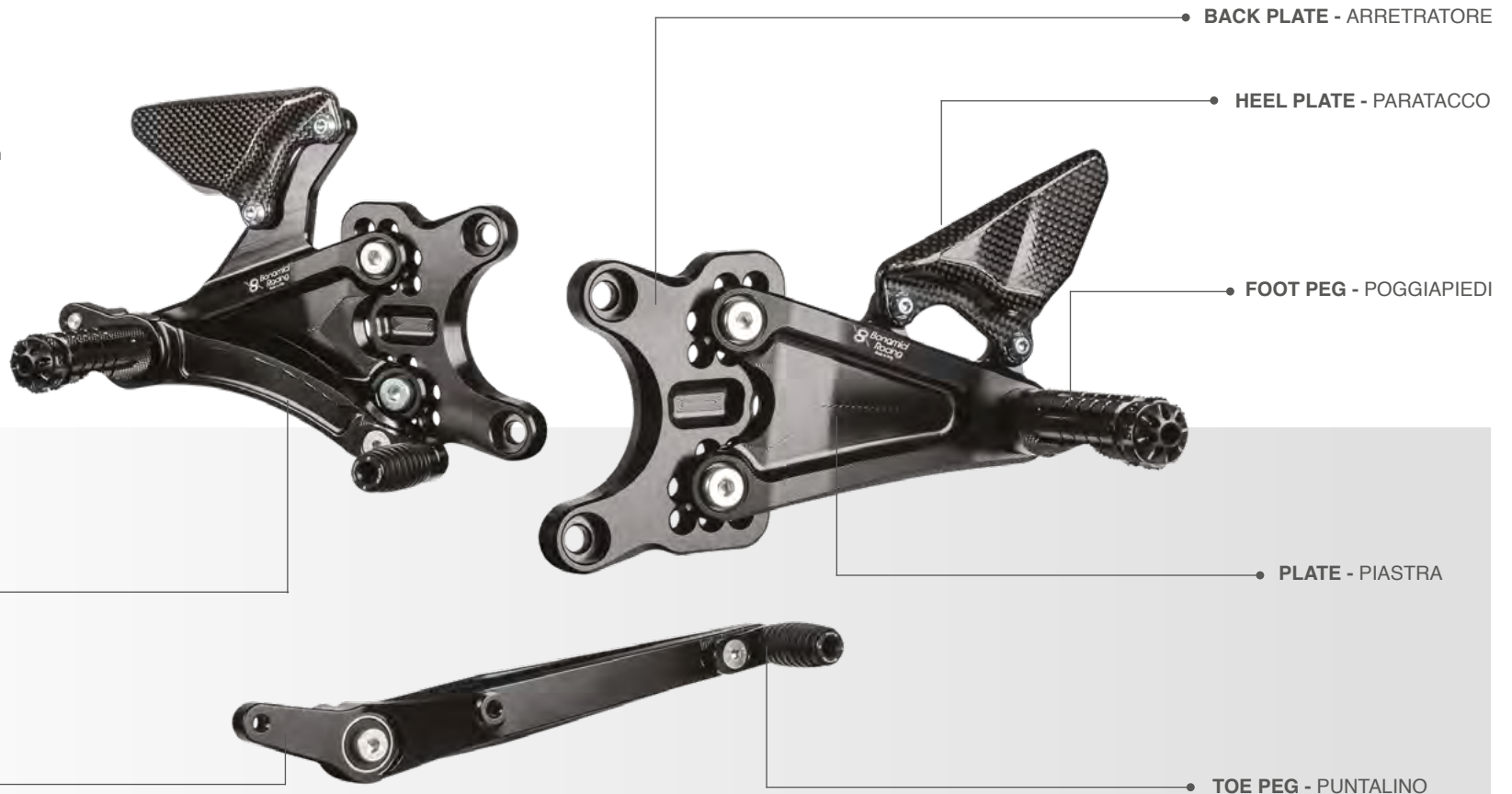

Bonamici Racing designs and manufactures rearsets for most of the models of sport-bikes on the market since 1994.

Made from billet high-strength aluminum alloys with CNC technology, Bonamici Racing rearsets have many peculiarities, among them there is the use of ball bearings to completely eliminate friction on the levers, spring for the assisted return of the rear brake lever and the possibility of adjustment in different positions.

All the rearsets in our catalog are anodized in black to have greater mechanical resistance and greater resistance to the chemical agents, in addition we have the possibility of customizing the platforms in many ways.

Bonamici Racing progetta e realizza pedane poggiapiedi per la maggior parte di modelli di moto sportive presenti sul mercato dal 1994.

Realizzate dal pieno in leghe di alluminio ad alta resistenza con tecnologia CNC, le pedane Bonamici Racing hanno molte peculiarità, tra queste vi è l'uso di cuscinetti a sfera per eliminare completamente gli attriti sui leveraggi, molla per il ritorno assistito della leva freno posteriore e la possibilità di regolazione in differenti posizioni.

Tutte le pedane presenti in catalogo sono anodizzate nel colore nero per avere una maggiore resistenza meccanica ed agli agenti chimici, inoltre c'è la possibilità di personalizzare le pedane in tanti modi.



NOTES - NOTE

A: remove the sprocket protection (only for reverse shifting) - rimuovere il carter copripignone (solo per cambio rovesciato)
B: remove the sprocket protection - rimuovere il carter copripignone
C: remove the plastic protection from the exhaust - rimuovere la protezione in plastica sullo scarico
D: remove the lateral stand - rimuovere il cavalletto laterale
D1: remove the lateral stand (only for reverse shifting) - rimuovere il cavalletto laterale (solo per cambio rovesciato)
F: includes the gear selector - include il selettore cambio
G: includes the rear oil tank - include il serbatoio olio posteriore
H: includes the warm carbon protection - include il paracalore in carbonio
I: includes carbon heel plates - include i paratacchi in carbonio
L: it is not possible to mount the hydrostop - non è possibile montare l'hydrostop
M: it need to modify the original fairing - occorre modificare le carene originali

N: can use in normal shifting mode - può funzionare con il cambio normale
O: it need to change the rear brake tube - è necessario sostituire il tubo freno posteriore
P: it's possible to mount carbon heel plates accessories - è possibile montare i paratacchi in carbonio come accessorio
R: can use in reverse shifting mode - può funzionare con il cambio rovesciato
T: it is not necessary to mount the hydrostop - non è necessario montare l'hydrostop
V: Includes folding foot pegs - Include poggia piedi chiudibili
W: it is possible to mount folding foot pegs without modifying the plate, see the table "folding foot pegs" on page 24 and page 25
 è possibile montare il poggia piedi chiudibile senza modificare la pedana, consultare la tabella "poggia piedi chiudibili" a pagina 24 e pagina 25

Please note: some models with and without ABS may need to replace the rear brake tubes
 Attenzione: per alcuni modelli con e senza ABS potrebbe essere necessario sostituire i tubi freni posteriori

APRILIA

MODEL - MODELLO **FROM - DAL** **TO - AL** **CODE - CODICE** **NOTES - NOTE**

RSV4 - Tuono V4	2009	2016	A003	N/R/F/P/W
RSV4 APRC - TUONO V4 APRC (street)	2011	2016	A004	N/P/W
RSV4 APRC - TUONO V4 APRC (race)	2011	2016	A004R	R/P/W
RSV4 - RSV4 RF - RSV4 <i>Factory</i> - Tuono V4 (street)	2017	>	A005S	N/P/T/W
RSV4 - RSV4 RF - RSV4 <i>Factory</i> - Tuono V4 (race)	2017	>	A005SR	R/P/T/W
RS 660 - Tuono 660	2020	>	A006	N/P/R/T/W



APRILIA RSV4 FACTORY
RSV4 RF - TUONO - cod. A005S

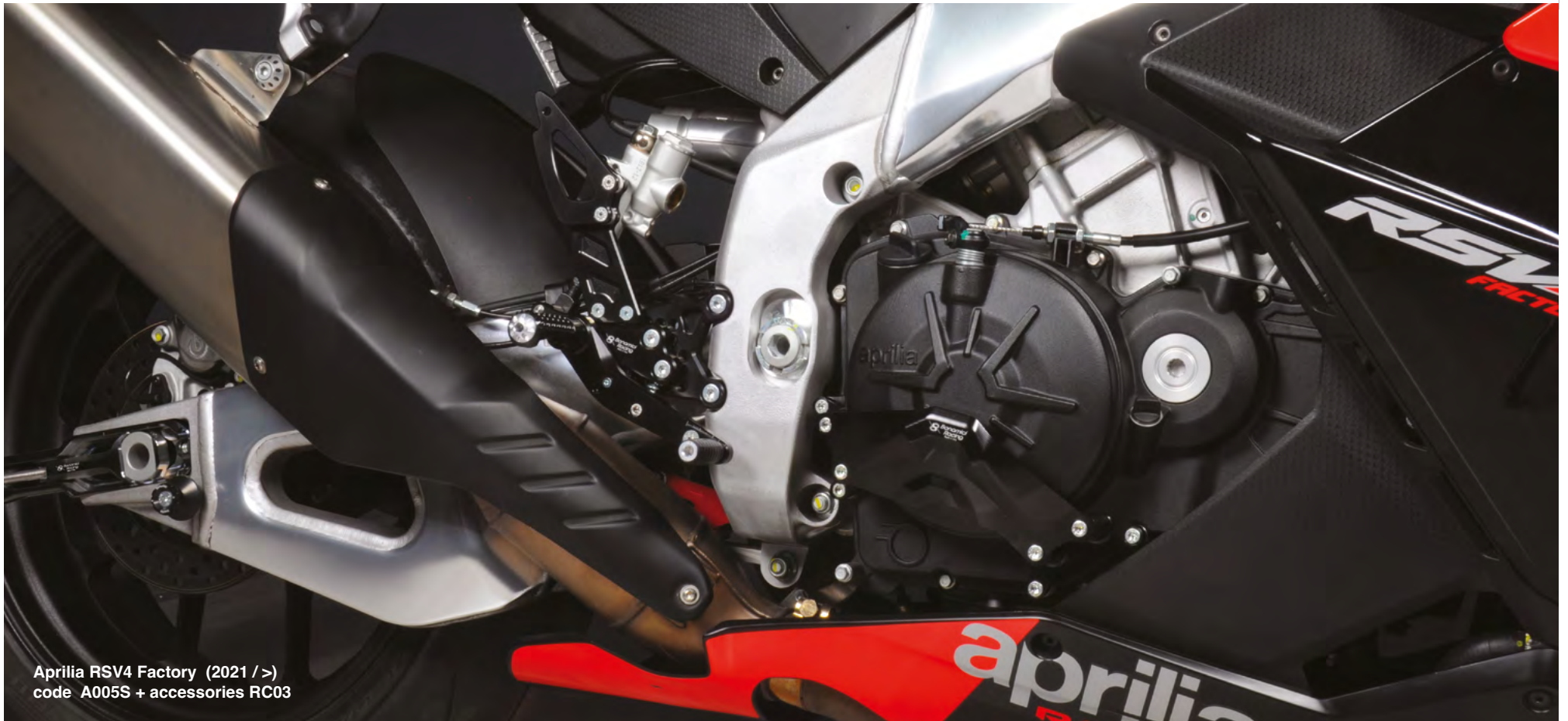

Aprilia RSV4 Factory (2021 / >)
code A005S + accessories RC03

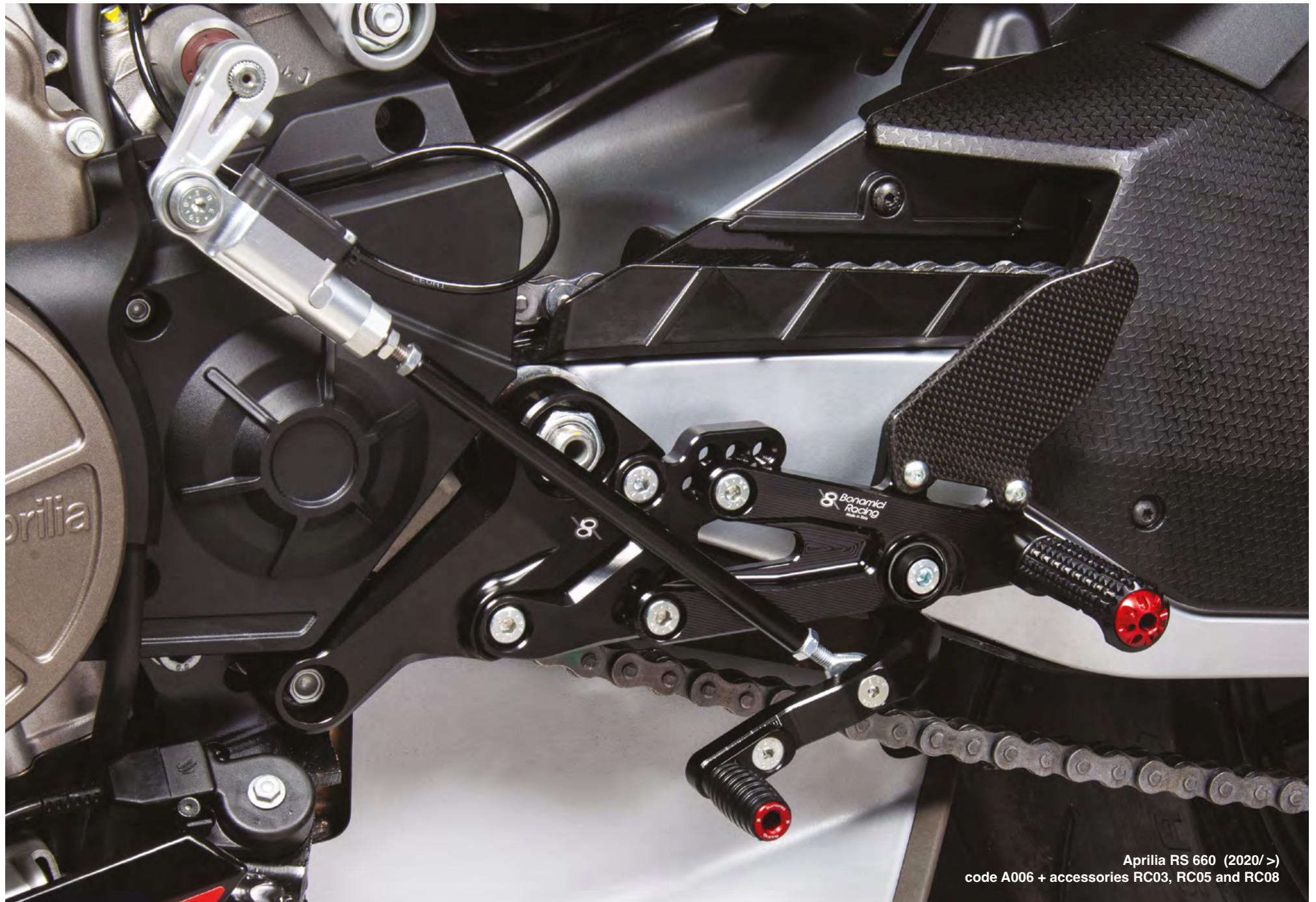

Aprilia RS 660 (2020/ >)
code A006 + accessories RC03, RC05 and RC08

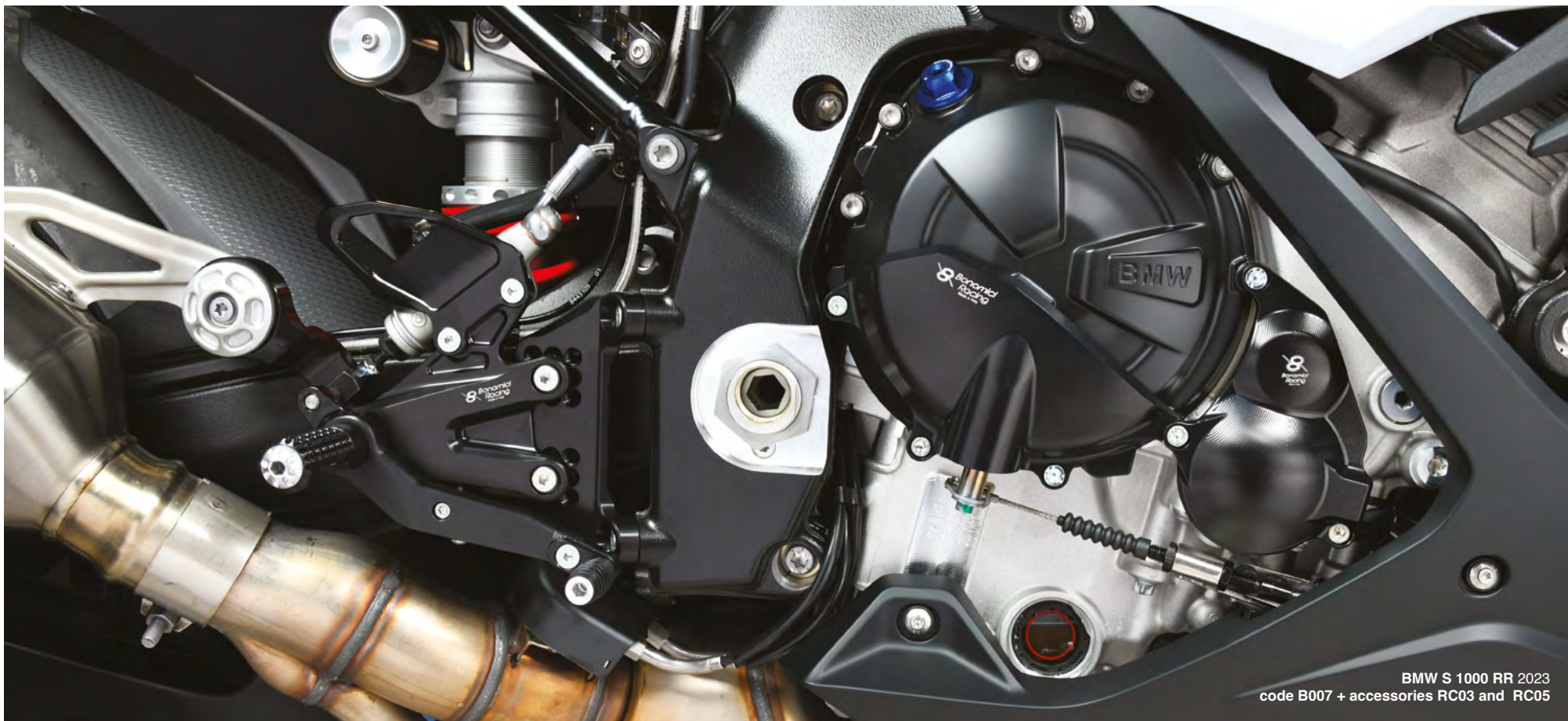

BMW S 1000 RR 2023
code B007 + accessories RC03 and RC05

BMW

MODEL - MODELLO

FROM - DAL

TO - AL

CODE - CODICE

NOTES - NOTE

MODEL - MODELLO	FROM - DAL	TO - AL	CODE - CODICE	NOTES - NOTE
S 1000 RR - HP4 (street)	2008	2014	B001	I/N/W
S 1000 RR - HP4 (race)	2008	2014	B001R	R/B/M/P/W
S 1000 RR	2015	2018	B005	N/R/P/W
S 1000 RR - M 1000 RR	2019	>	B007	N/R/P/T/W
S 1000 R (street)	2012	2016	B001	I/N/W
S 1000 R (race)	2012	2016	B001R	R/B/P/W
S 1000 R - M 1000 R	2021	>	B008	N/R/P/T/W
S 1000 XR	2020	>	B009	N/P/T/V



● BMW S 1000 RR - cod. B007

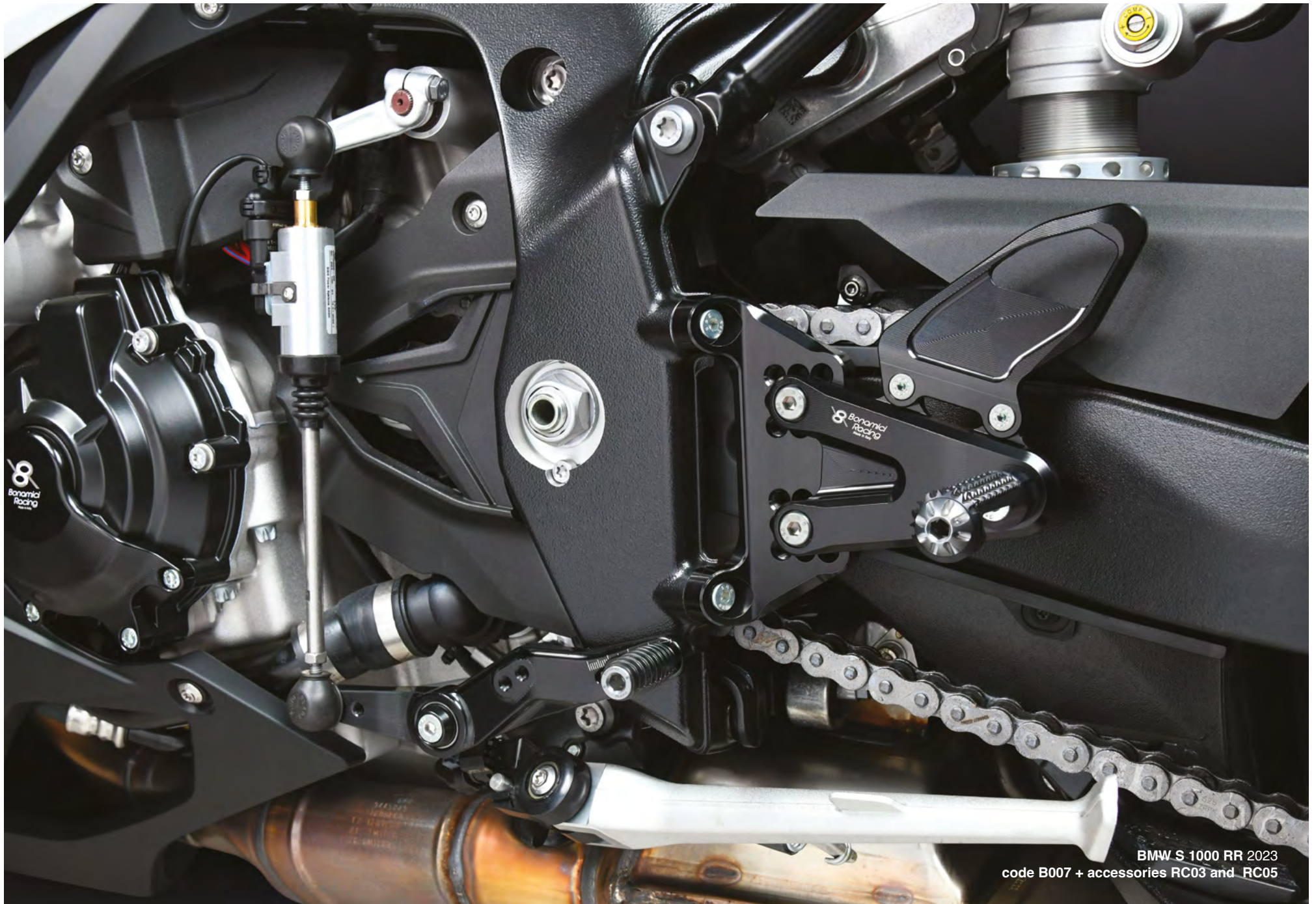

BMW S 1000 RR 2023
code B007 + accessories RC03 and RC05

Ducati Panigale V4 (2018-2024)
code DV4 + accessories RC03



DUCATI 899 / 1098 / 1198 - cod. D1098



DUCATI PANIGALE V2 - cod. DV2



DUCATI PANIGALE V4 - cod. DV4

DUCATI

MODEL - MODELLO	FROM - DAL	TO - AL	CODE - CODICE	NOTES - NOTE
748 / 916 / 996 / 998	1994	2004	D916	N/R/T/W
749 / 999	2002	2006	D999	N/R/T/W
848 / 1098 / 1198	2007	2011	D1098	N/R/T/W
899 / 959 / 1199 / 1299 Panigale	2012	2018	DV2	N/R/W
Panigale V4 / V4S / V4R	2018	2024	DV4	N/R/P/W
Panigale V2	2020	2024	DV2	N/R/W
Streetfighter V2	2022	>	DSTR3	N/R/W
Streetfighter V4	2020	>	DSTR2	N/R/P/W

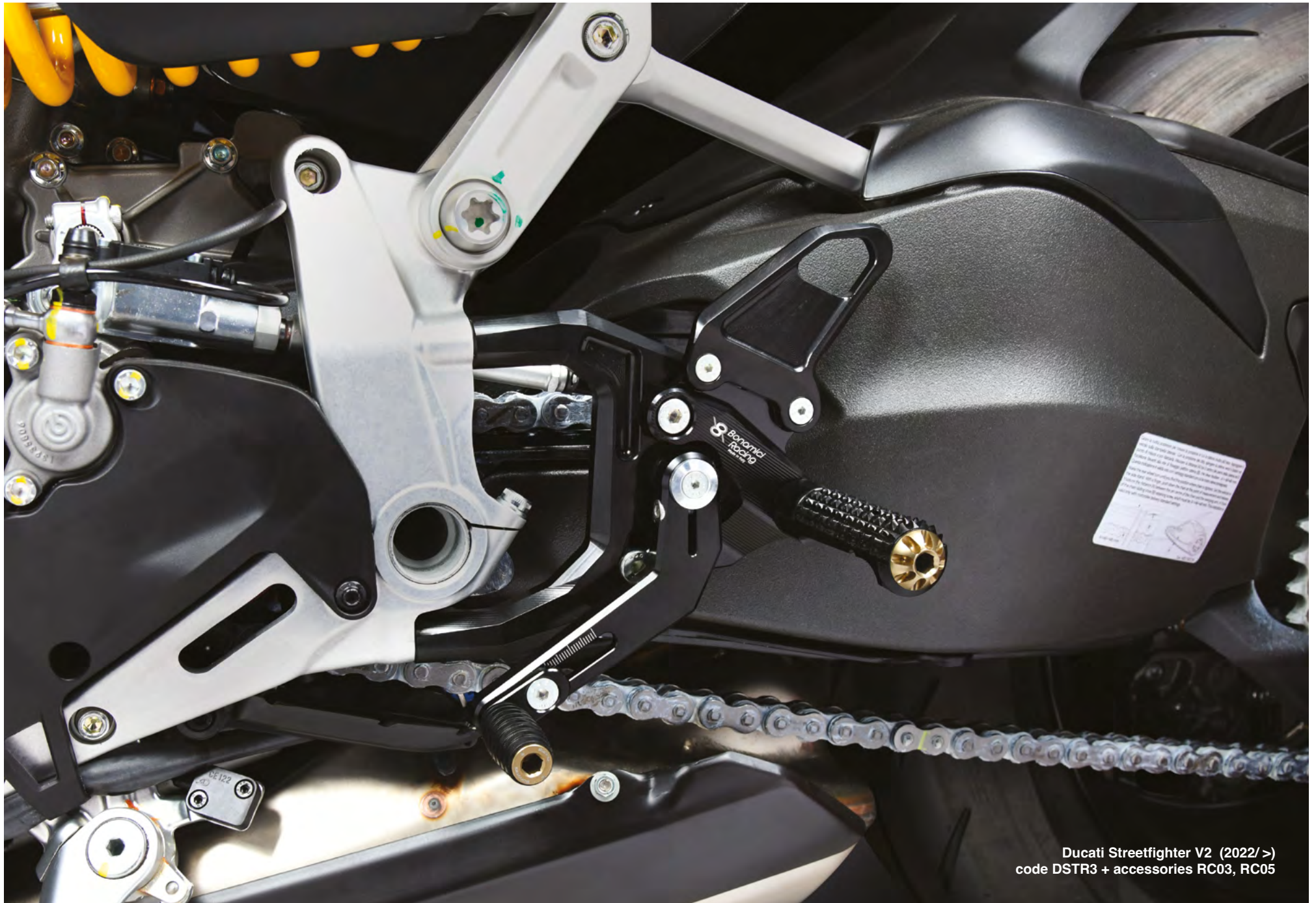

Ducati Streetfighter V2 (2022/ >)
code DSTR3 + accessories RC03, RC05

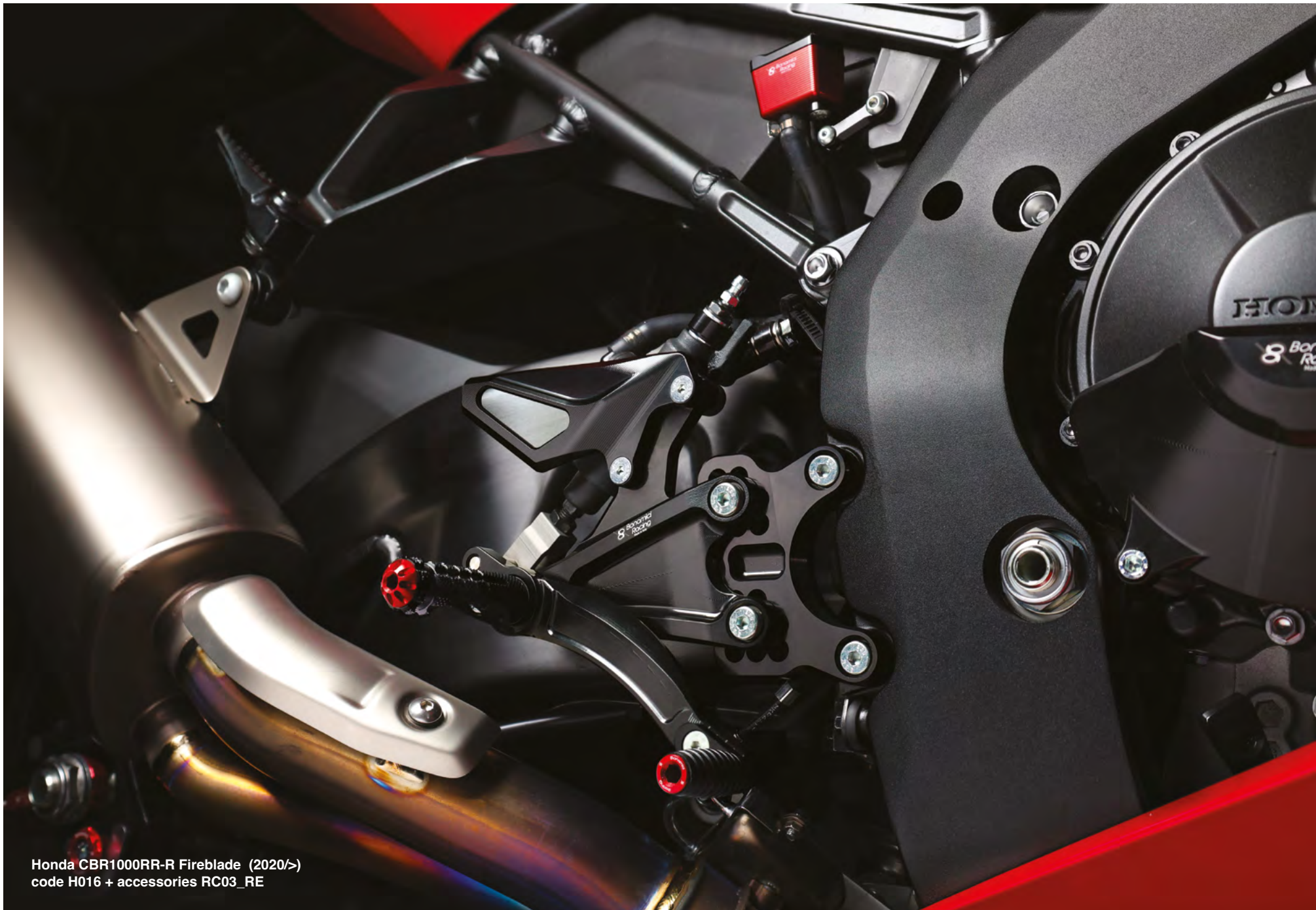

Honda CBR1000RR-R Fireblade (2020/>)
code H016 + accessories RC03_RE

HONDA



NEW

HONDA CBR 600 RR - cod. H018



HONDA CBR 650 R/CB 650 R/F - cod. H012



HONDA CBR1000RR-R FIREBLADE - cod. H015

MODEL - MODELLO	FROM - DAL	TO - AL	CODE - CODICE	NOTES - NOTE
CBR 600 RR	2007	>	H018	F/N/R/W
CBR 1000 RR (street)	2008	2016	H008	F/N/R/W
CBR 1000 RR (race)	2008	2016	H009	R/P/W
CBR 1000 RR Fireblade	2017	2019	H013	F/N/R/P/W
CBR 1000 RR Fireblade SP/SP2	2017	2019	H014	F/N/R/P/W
CBR 1000 RR-R Fireblade "Racing" / SP	2020	>	H015	N/R/O/P/W
CBR 1000 RR-R Fireblade "Standard" / SP	2020	>	H016	N/R/P/W
CBR 650 R/CB 650 R/F without Quickshifter - senza QS	2014	>	H012	N/R/W



Honda CBR 600 RR (2007/ >)
code H018 + accessories RC03_BL

KAWASAKI

MODEL - MODELLO	FROM - DAL	TO - AL	CODE - CODICE	NOTES - NOTE
Ninja 250/400	2018	2023	K019	N/R/F/P/W
Ninja 250/400 * Raised +25 mm compared to K019	2018	2023	K019_25	N/R/F/P/W
ZX-4R/RR	2023	>	K022	N/R/F/T/W
ZX-6R	2005	2006	K005	N/R/P/W
ZX-6R	2007	2008	K006	N/R/P/W
ZX-6R	2009	2017	K010	N/R/P/W
ZX-6R	2019	>	K020	N/P/O/W
ZX-10R	2011	2015	K012	N/R/F/P/W
ZX-10R	2016	2020	K015	N/F/P/W
ZX-10R	2021	>	K021	N/R/F/T/W
Z 650/Ninja 650	2017	2019	K018	N/R/F/P/W
Z 900	2017	>	K023	A/N/R/F/P/W

* The brake hose needs to be replaced - ** È necessario sostituire il tubo freno



KAWASAKI ZX-10R - cod. K021

KTM

MODEL - MODELLO	FROM - DAL	TO - AL	CODE - CODICE	NOTES - NOTE
790 / 890 Duke / 890 Duke R	2018	2023	KT04	N/R/P/T/W
1290 Super Duke / R / GT	2013	2019	KT03	N/R/P/W
1290 Super Duke R	2020	2023	KT06	N/R/T/W
NEW 1390 Super Duke R	2024	>	KT06	N/R/T/W



790 / 890 Duke / 890 Duke R - cod. KT04



KTM 1390 Super Duke (2024/>)
code KT06 + accessories RC03_OR



1390 Super Duke R (2024->) - cod. KT06

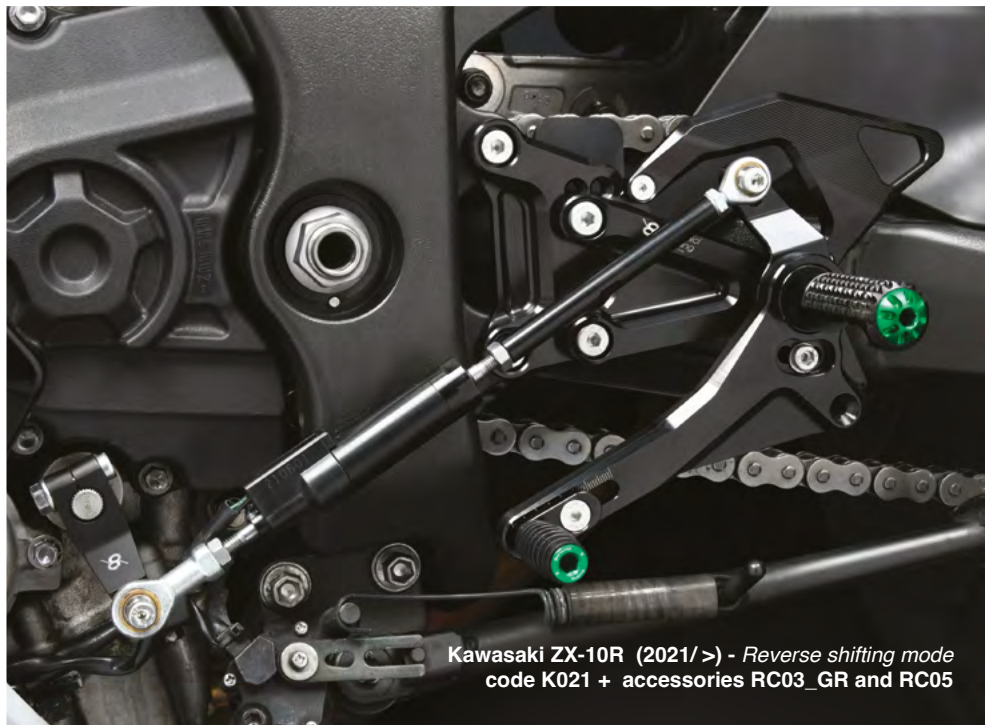

Kawasaki ZX-10R (2021/ >) - Reverse shifting mode
code K021 + accessories RC03_GR and RC05

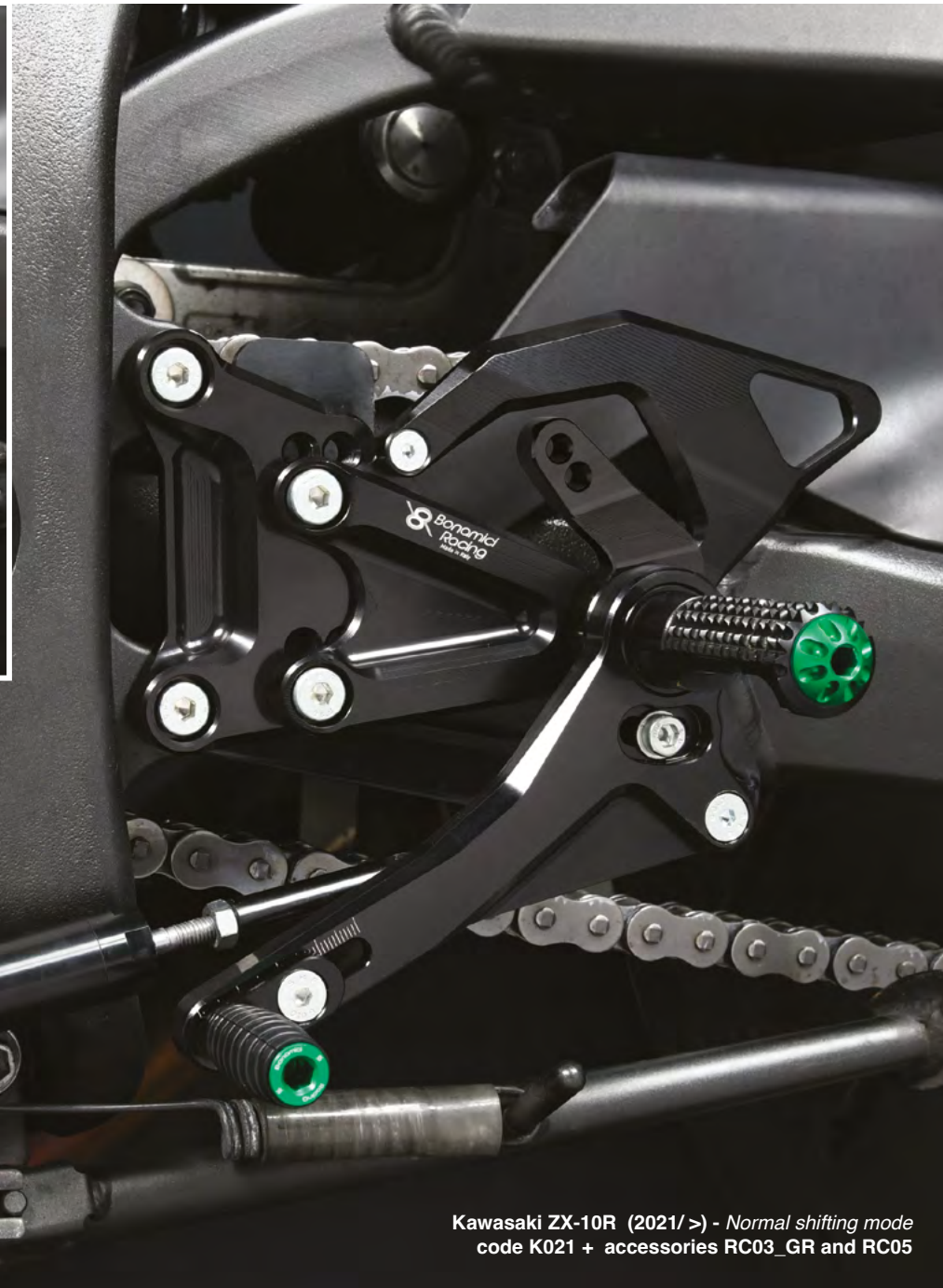

Kawasaki ZX-10R (2021/ >) - Normal shifting mode
code K021 + accessories RC03_GR and RC05

Triumph Speed Triple 1200 RR (2022/>)
code TH07 + accessories RC03 and RC05

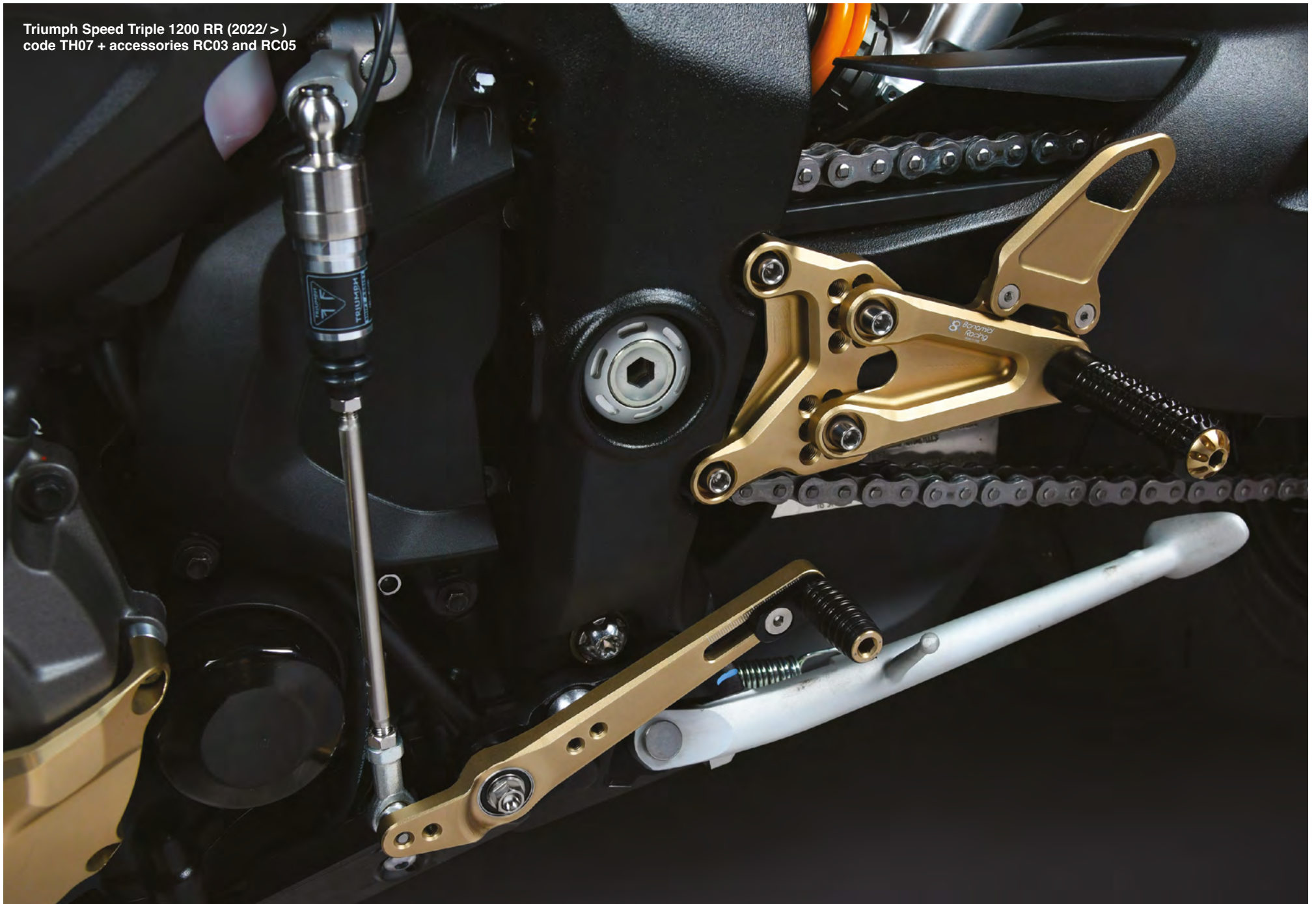



● SUZUKI GSX-R 1000 - cod. S011

SUZUKI

MODEL - MODELLO	FROM - DAL	TO - AL	CODE - CODICE	NOTES - NOTE
NEW GSX- 8S / 8R	2023	>	S014	N/R/W
GSX-R 600 / 750	2006	2010	S004	N/R/P/W
GSX-R 600 / 750	2011	2017	S008	N/R/P/W
GSX-R 1000	2007	2008	S006	N/R/P/W
GSX-R 1000	2009	2016	S007	N/R/P/W
GSX-R 1000	2017	>	S011	N/R/P/W



● TRIUMPH SPEED TRIPLE 1200 RR - cod. TH07

TRIUMPH

MODEL - MODELLO	FROM - DAL	TO - AL	CODE - CODICE	NOTES - NOTE
Daytona 675 without Quickshifter - senza QS	2013	2017	TH03	F/N/R/W
Daytona 675 Quickshifter (street)	2013	2017	TH03	F/N/W
Daytona 675 Quickshifter (race)	2013	2017	TH03R	F/R/W
Street Triple 675	2013	2016	TH04	F/N/R/W
Street Triple S/R/RS 765	2017	2022	TH06	F/N/L/P/R/W
Street Triple 765 R/RS/Moto 2	2023	>	TH09	F/N/P/R/T/W
Speed Triple 1200 RS	2021	>	TH08	N/R/T/W
Speed Triple 1200 RR	2022	>	TH07	N/R/T/W

YAMAHA



● YAMAHA YZF R6 - cod. Y013

MODEL - MODELLO	FROM - DAL	TO - AL	CODE - CODICE	NOTES - NOTE
YZF R3 / R25	2015	>	Y012	F/N/R/P/W
YZF R3 / R25 ** Raised +40 mm compared to Y012	2015	>	Y012_40	F/N/R/P/W
YZF R6 *	2003	2005	Y004	N/F/P/W
YZF R6	2006	2016	Y005	N/R/P/W
YZF R6	2017	>	Y013	N/R/W
YZF R1 *	1998	2003	Y001	N/R/P/W
YZF R1(street) *	2004	2006	Y002	N/F/P/W
YZF R1(race) *	2004	2006	Y002R	R/B/P/W
YZF R1(street)	2007	2008	Y006	N/C/F/P/W
YZF R1(race)	2007	2008	Y006R	R/C/P/W
YZF R1	2009	2014	Y007	N/R/P/W

* Available only on specific request - * Disponibili solo su specifica richiesta

** The brake hose needs to be replaced - ** È necessario sostituire il tubo freno

MODEL - MODELLO	FROM - DAL	TO - AL	CODE - CODICE	NOTES - NOTE
YZF R1/R1M	2015	>	Y011	N/R/P/W
YZF R1/R1M Rearset with bracket for OEM Akrapovic exhaust Pedana con staffa per scarico Akrapovic OEM	2015	2022	Y011A	N/R/P/W
YZF R7	2021	>	Y015	N/R/T/W
MT-07/FZ07	2014	2020	Y010	N/R/P/W
MT-09	2021	>	Y016	F/N/R/T/W



YAMAHA YZF R1/R1M - cod. Y011

WARNING
ATTENZIONE

- Before use, make sure that all screws are tightened with care. Use light strength thread-locker.
 - The assistance of professional staff is necessary for all the parts which require installation.
 - All Bonamici Racing products are made for racing use only (not for street use).
 - After any kind of impact, it is obligatory to replace the affected parts.
 - It is obligatory to check the tightened of the screws after every ride session.
- Prima dell'uso, assicurarsi che tutte le viti siano serrate con cura. Usa un frenafili.
 - Per tutte le parti che necessitano di installazione è necessaria l'assistenza di personale qualificato.
 - Tutti i prodotti Bonamici Racing sono realizzati esclusivamente per uso agonistico (non per uso stradale).
 - Dopo ogni tipo di urto è obbligatorio sostituire le parti interessate.
 - È obbligatorio controllare il serraggio delle viti dopo ogni sessione di guida.



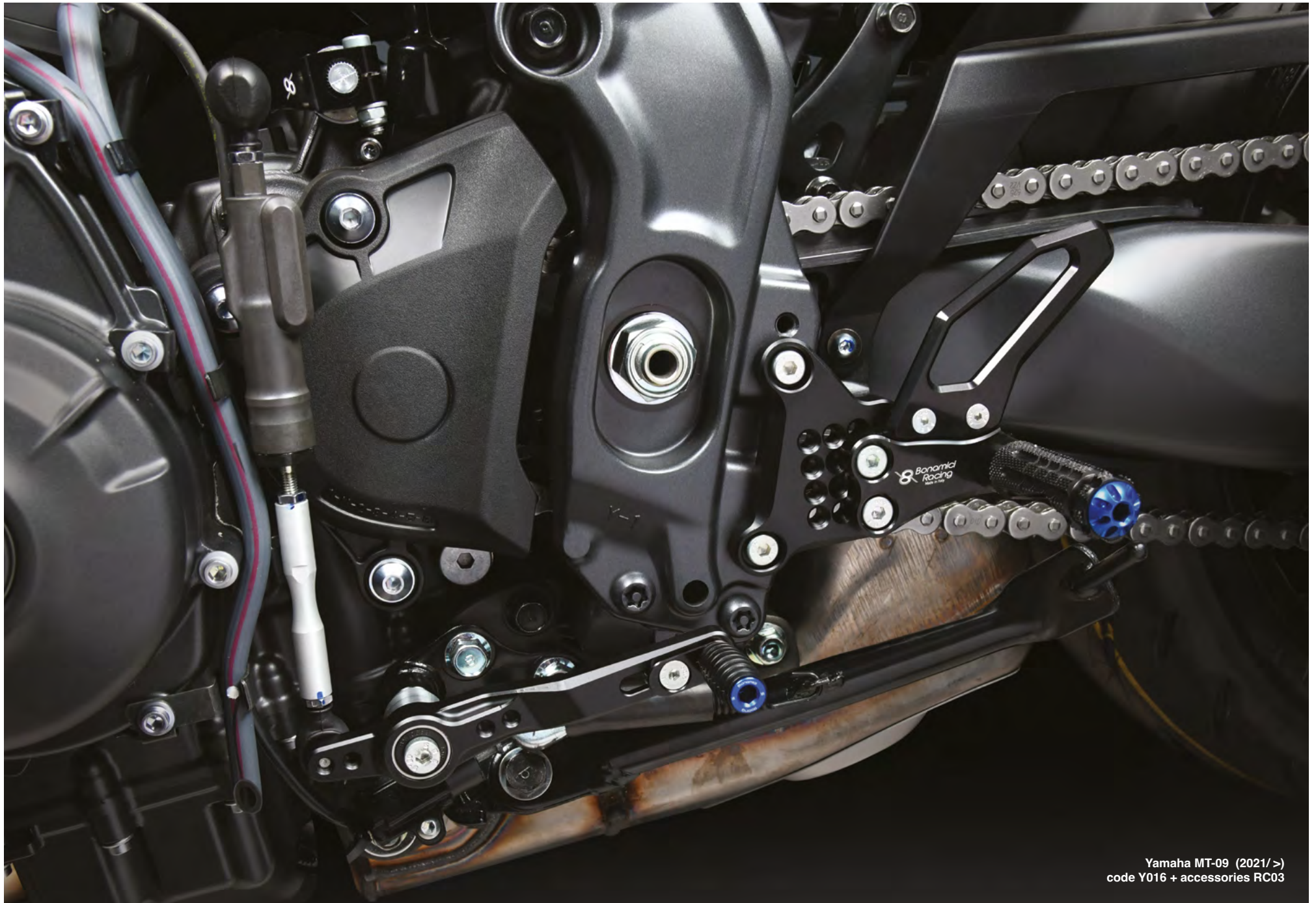

Yamaha MT-09 (2021/ >)
code Y016 + accessories RC03

REARSETS ACCESSORIES - ACCESSORI PEDANE

The full range of Bonamici Racing rearsets is supplied in the “Standard” version with black color, aluminum heelplates, fixed foot pegs and toe pegs. At the time of purchase it is possible to request the rearsets in different colors and with laser engraving, the rest of the accessories can all be purchased separately. Pay attention to the “notes” on the rearsets page.

L'intera gamma pedane Bonamici Racing è fornita nella versione “Standard” con colore nero, paratacchi in alluminio, poggiapiedi e puntalini fissi. Al momento dell'acquisto è possibile richiedere la pedana in diversi colori e con incisione laser, il resto degli accessori sono acquistabili tutti separatamente. Fare attenzione alle “note” nella pagina pedane.

	CODE - CODICE	NOTES - NOTE
Pair of racing foot pegs - Coppia di poggiapiedi racing (82mm+82mm)	RC05_LL	3
Pair of racing foot pegs - Coppia di poggiapiedi racing (69mm+82mm)	RC05_SL	3
Pair of racing foot pegs - Coppia di poggiapiedi racing (69mm+69mm)	RC05_SS	3
Pair of folding foot pegs - Coppia di poggiapiedi chiudibili	KPC	3/4
Pair of standard folding toe pegs - Coppia di puntalini chiudibili standard	RC02	5
Pair of knurled folding toe pegs - Coppia di puntalini chiudibili godronati	RC02G	5
Pair of striped folding toe pegs - Coppia di puntalini chiudibili rigati	RC02R	5
Pair of carbon heel plates - Coppia di paratacchi in carbonio	RC08	1
Hydrostop M10 x 1 - Interruttore stop idraulico M10 x 1	HD100	2
Hydrostop M10 x 1,25 - Interruttore stop idraulico M10 x 1,25	HD125	2
Wired hydrostop for Ducati - Interruttore stop cablato per Ducati	HDC01	-
Wired hydrostop for Ducati Streetfighter V4/V2 - Interruttore stop cablato per Ducati Streetfighter V4/V2	HDC02	-
Pairs of colored aluminum caps and toe pegs (blue) - Coppie di tappi e puntalini in alluminio colorati (blu)	RC03_BL	-
Pairs of colored aluminum caps and toe pegs (green) - Coppie di tappi e puntalini in alluminio colorati (verde)	RC03_GR	-
Pairs of colored aluminum caps and toe pegs (gold) - Coppie di tappi e puntalini in alluminio colorati (oro)	RC03_GO	-
Pairs of colored aluminum caps and toe pegs (orange) - Coppie di tappi e puntalini in alluminio colorati (arancione)	RC03_OR	-
Pairs of colored aluminum caps and toe pegs (red) - Coppie di tappi e puntalini in alluminio colorati (rosso)	RC03_RE	-
Pairs of colored aluminum caps and toe pegs (silver) - Coppie di tappi e puntalini in alluminio colorati (argento)	RC03_SI	-
Pairs of colored aluminum caps and toe pegs (bronze) - Coppie di tappi e puntalini in alluminio colorati (bronzo)	RC03_BR	-
Aluminium stand for rearsets - Espositore pedane in Alluminio	EX01	-

CUSTOMIZATION - PERSONALIZZAZIONE

• By purchasing a new rearset kit it is possible to request the following customization services

• Acquistando una nuova pedana è possibile richiedere i seguenti accessori

DESCRIPTION - DESCRIZIONE	CODE - CODICE
Laser engravings (one pair) - Incisioni laser (coppia)	KLS2
Extra colour for rearsets - Colore extra per pedane	KK07

NOTES - NOTE

- To verify the possibility in the rearset notes (“P”) Verificare la possibilità nelle note delle pedane (“P”)
- Available only for the OEM switch stop with two cables Disponibile solo per impianti stop originali a due cavi
- Black foot pegs caps Tappi poggiapiedi di colore nero
- For the complete code see table of folding foot pegs on page. 24 and page 25 Per il codice completo vedere tabella poggiapiedi chiudibili a pag. 24 e pag.25
- Available only in black colour Disponibili solo di colore nero

WARNING ATTENZIONE

- It's possible to find all the spare parts on the specific catalog
- È possibile trovare tutte le parti di ricambio sul catalogo specifico

Folding foot pegs code Codici poggiapiedi chiudibili



Rearsets code Codice pedana	Models Modello	Foot pegs code Codice poggiapiedi
APRILIA	A003 RSV4 - Tuono V4 ('09/'16)	KPC01
	A004 RSV4 APRC - Tuono V4 APRC (street) ('11/'16)	KPC01
	A004R RSV4 APRC - Tuono V4 APRC (race) ('11/'16)	KPC01
	A005S RSV4 APRC - Tuono V4 APRC (street) ('17/ >)	KPC01
	A005SR RSV4 APRC - Tuono V4 APRC (race) ('17/ >)	KPC01
	A006 RS660 ('20/ >)	KPC01

Rearsets code Codice pedana	Models Modello	Foot pegs code Codice poggiapiedi
BMW	B001 S 1000 RR/S 1000 R (street) ('08/'14)	KPC06
	B001R S 1000 RR/S 1000 R (race) ('08/'14)	KPC01
	B005 S 1000 RR ('15/'18)	KPC01
	B007 S 1000 RR - M 1000 RR ('19/ >)	KPC03
	B008 S 1000 R - M 1000 R ('21/ >)	KPC03

Rearsets code Codice pedana	Models Modello	Foot pegs code Codice poggiapiedi
DUCATI	D916 748/916/996/998 ('94/'04)	KPC04
	D999 749/999 ('02/'06)	KPC04
	D1098 848/1098/1198 ('07/'11)	KPC04
	DV2 899/1199/1299 Panigale/V2 ('12/'24)	KPC02
	DV4 Panigale V4 ('18/'24)	KPC02
	DSTR3 Streetfighter V2 ('22/ >)	KPC02
	DSTR2 Streetfighter V4 ('20/ >)	KPC02

Folding foot pegs code - Codici poggiapiedi chiudibili

Rearsets code Codice pedana	Models Modello	Foot pegs code Codice poggiapiedi
H008	CBR 1000 RR (street) ('08/'16)	KPC01
H009	CBR 1000 RR (race) ('08/'16)	KPC01
H012	CBR 650 F/CB 650 F ('14/>)	KPC01
H013	CBR 1000 RR Fireblade ('17/'19)	KPC01
H014	CBR 1000 RR Fireblade SP/SP2 ('17/'19)	KPC01
H015	CBR 1000 RR-R Fireblade (racing) ('20/>)	KPC01
H016	CBR 1000 RR-R Fireblade (standard) ('20/>)	KPC01
H018	CBR 600 RR Fireblade ('07/>)	KPC05

Rearsets code Codice pedana	Models Modello	Foot pegs code Codice poggiapiedi
K005	ZX-6R ('05/'06)	KPC01
K006	ZX-6R ('07/'08)	KPC01
K010	ZX-6R ('09/'17)	KPC01
K012	ZX-10R ('11/'15)	KPC01
K015	ZX-10R ('16/'20)	KPC01
K018	Z 650 ('17/'19)	KPC01
K019	Ninja 250/400 ('18/'23)	KPC01
K020	ZX-6R ('19/>)	KPC01
K021	ZX-10R ('21/>)	KPC02
K022	ZX-4R/RR ('23/>)	KPC02
K023	Z 900 ('17/>)	KPC01

Rearsets code Codice pedana	Models Modello	Foot pegs code Codice poggiapiedi
KT03	Duke 790/890 ('18/'23)	KPC02
KT03	1290 Super Duke R ('13/'19)	KPC06
KT06	1290 Super Duke R ('20/'23)	KPC06
KT06	1390 Super Duke R ('24/>)	KPC06

Rearsets code Codice pedana	Models Modello	Foot pegs code Codice poggiapiedi
S004	GSX-R 600/750 ('06/'10)	KPC01
S006	GSX-R 1000 ('07/'08)	KPC01
S007	GSX-R 1000 ('09/'16)	KPC01
S008	GSX-R 600/750 ('11/'17)	KPC01
S011	GSX-R 1000 ('17/>)	KPC01
S014	GSX-8S/8R ('23/>)	KPC05

Rearsets code Codice pedana	Models Modello	Foot pegs code Codice poggiapiedi
TH03	Daytona 675 ('13/'17)	KPC01
TH03R	Daytona 675 Quickshifter ('13/'17)	KPC01
TH04	Street Triple 675 ('13/'16)	KPC01
TH06	Street Triple 765/800 ('17/'22)	KPC01
TH07	Speed Triple 1200 RR ('22/>)	KPC01
TH08	Speed Triple 1200 RS ('21/>)	KPC01
TH09	Street Triple 765 R/RS/Moto 2 (2023/>)	KPC01

Rearsets code Codice pedana	Models Modello	Foot pegs code Codice poggiapiedi
Y001	YZF R1 ('98/'03)	KPC05
Y002	YZF R1 (street) ('04/'06)	KPC05
Y002R	YZF R1 (race) ('04/'06)	KPC05
Y004	YZF R6 ('03/'05)	KPC05
Y005	YZF R6 ('06/'16)	KPC01
Y006	YZF R1 (street) ('07/'08)	KPC01
Y006R	YZF R1 (race) ('07/'08)	KPC01
Y007	YZF R1 ('09/'14)	KPC01
Y008	MT-09/FZ09 ('13/'20)	KPC01
Y010	MT-07/FZ07 ('14/'20)	KPC01
Y011	YZF R1/R1M ('15/>)	KPC01
Y012	YZF R3 ('15/>)	KPC01
Y013	YZF R6 ('17/>)	KPC01
Y015	YZF R7 ('21/>)	KPC05
Y016	MT-09 ('21/>)	KPC05





WorldSBK TeamHRC rider Iker Lecuona shows Bonamici Racing rearset



Racing foot pegs / Poggiapiedi racing - cod. RC05 **Folding foot pegs / poggiapiedi chiudibili** - cod. KPC



Standard folding toe pegs
Puntalini chiudibili standard cod. RC02 **Knurled Folding toe pegs**
Puntalini chiudibili godronati cod. RC02G **Striped folding toe pegs**
Puntalini chiudibili rigati - cod. RC02R

GEAR SPACER SUPPORT - SUPPORTO DISTANZIALE CAMBIO

Spacer who allows the mounting of the rearsets without using the side stand.

Supporto per montare le pedane senza l'utilizzo del cavalletto laterale.

MODEL - MODELLO	FROM - DAL	TO - AL	CODE - CODICE
Honda CBR 600 RR	2024	>	DC_042D
Honda CBR 1000RR-R	2020	2023	DC_040B
Suzuki GSX-8S/8R	2023	>	DC_043B
BMW S 1000 RR - M 1000 RR	2019	>	DC_039B
BMW S 1000 R	2021	>	DC_039B
Yamaha YZF R6	2017	>	DC_037B

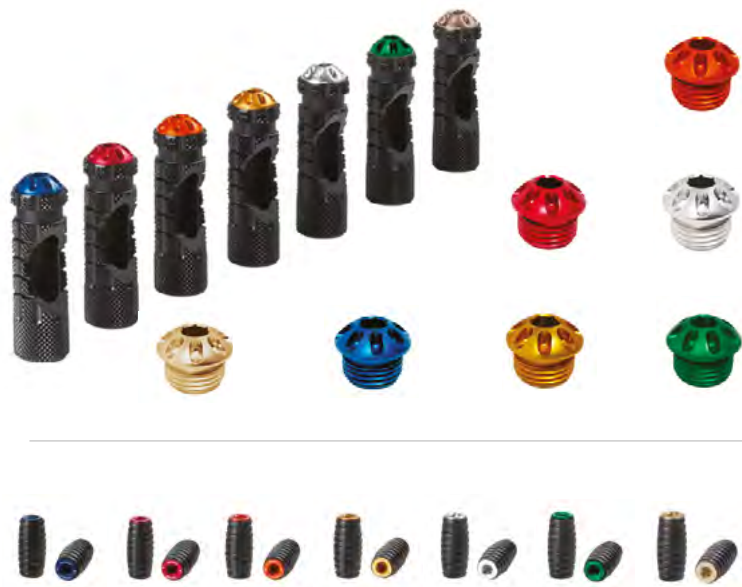

Pairs of caps and standard toe pegs coloured
Coppie di tappi e puntalini standard colorati - cod. RC03

• The rearsets pictured is for illustrative purposes only
• La pedana nella foto è solo a scopo illustrativo



Extra colour for rearset - Colore extra per pedane - cod. KK07



Hydrostop M10 x 1
Interruttore stop idraulico M10 x 1 - cod. HD100

Hydrostop M10 x 1,25
Interruttore stop idraulico M10 x 1,25 - cod. HD125



Wired hydrostop for Ducati
Interruttore stop cablato per Ducati - cod. HDC01



Wired hydrostop for Ducati Streetfighter V4
Interruttore stop cablato per Ducati Streetfighter V4 - cod. HDC02

• The heelplates pictured is for illustrative purposes only
• I paratacchi nella foto sono solo a scopo illustrativo



Laser engravings (one pair)
Incisioni laser (coppia) - cod. KLS2



Pair of carbon heel plates
Coppia di paratacchi in carbonio - cod. RC08





Bonamici Racing components were used by Leopard racing and Jaume Masia for the victory of the 2023/24 Moto3 world championship

ENGINE PROTECTIONS - PROTEZIONI MOTORE



The Bonamici Racing engine protection comes from the collaboration with the teams involved in the World Superbike Championship.

Made by high-strength aluminum alloy, machined from solid with CNC technology and finished with black anodizing, the engine cover kit perfectly protects the carter during falls and slides. It is composed by two or three elements, depending by the model, who protect the carter on both sides of the bike.

The engine protections can be purchased both in kit and individually and it's possible to customize them in other colors or with laser engraving according to customer specifications.

Bonamici Racing boasts the widest range of aluminum engine protections dedicated to the major sport-bikes on the market.

Dalla collaborazione con i team che corrono nel mondiale superbike, nascono le protezioni carter motore della Bonamici Racing.

In lega d'alluminio ad alta resistenza, lavorato dal pieno con tecnologia CNC e rifinito con anodizzazione nera, il kit protegge perfettamente i carter della moto in caso di eventuali cadute.

E' composto da due o tre elementi che proteggono i carter da entrambi i lati della moto. Le protezioni carter sono disponibili sia in kit che singolarmente ed è possibile personalizzarle in altri colori o con incisione laser su specifica del cliente.

Bonamici Racing vanta la più ampia gamma di protezioni motore in alluminio dedicate alle maggiori moto sportive del mercato.



Ducati Panigale V4
Right side - code CP079

APRILIA

MODEL - MODELLO	DESCRIPTION - DESCRIZIONE	FROM - DAL	TO - AL	CODE - CODICE
RSV4 - RSV4 <i>FACTORY</i> - Tuono V4	right side - lato DX	2021	>	CP001
RSV4 - RSV4 <i>FACTORY</i> - Tuono V4	left side - lato SX	2021	>	CP106
RSV4 - RSV4 <i>FACTORY</i> - Tuono V4	full kit - kit completo	2021	>	CP107
RS 660 - Tuono 660 - Tuareg 660	right side - lato DX	2020	>	CP111
RS 660 - Tuono 660 - Tuareg 660	left side - lato SX	2020	>	CP112
RS 660 - Tuono 660 - Tuareg 660	left side (water pump) lato SX (pompa acqua)	2020	>	CP113
RS 660 - Tuono 660 - Tuareg 660	full kit - kit completo	2020	>	CP114



APRILIA RSV4 Factory (2021 / >)
full kit - kit completo - cod. CP107



Aprilia RS660
right side - code CP111



APRILIA RS 660 (2020 / >)
full kit - kit completo - cod. CP114



Aprilia RS660
left side - code CP112



Aprilia RSV4 FACTORY (2021)
right side - code CP001

MODEL - MODELLO	DESCRIPTION - DESCRIZIONE	FROM - DAL	TO - AL	CODE - CODICE
S 1000 RR - M 1000 RR	right side (pick-up) - lato DX (pick-up)	2019	>	CP084C
S 1000 RR - M 1000 RR	right side (clutch) - lato DX (frizione)	2019	>	CP085B
S 1000 RR - M 1000 RR	left side "racing" (2pcs.) lato SX "racing" (2pz.)	2019	>	CP082B
S 1000 RR - M 1000 RR	left side (water pump) lato SX (pompa acqua)	2019	>	CP083
S 1000 RR - M 1000 RR	full kit "racing" (5pcs.) kit compl. "racing" (5pz.)	2019	>	CP086B
S 1000 R - M 1000 R	right side (pick-up) - lato DX (pick-up)	2021	>	CP084C
S 1000 R - M 1000 R	right side (clutch) - lato DX (frizione)	2021	>	CP085B
S 1000 R - M 1000 R	left side "racing" (2pcs.) lato SX "racing" (2pz.)	2021	>	CP082B
S 1000 R - M 1000 R	left side (water pump) lato SX (pompa acqua)	2021	>	CP083
S 1000 R - M 1000 R	full kit "racing" (5pcs.) kit compl. "racing" (5pz.)	2021	>	CP086B
S 1000 XR	right side (pick-up) - lato DX (pick-up)	2020	>	CP084C
S 1000 XR	right side (clutch) - lato DX (frizione)	2020	>	CP085B
S 1000 XR	left side - lato SX	2020	>	CP115
S 1000 XR	left side (water pump) lato SX (pompa acqua)	2020	>	CP083
S 1000 XR	full kit (4pcs.) kit completo (4pz.)	2020	>	CP116



BMW S 1000 XR 2020
code CP116



Left side "racing" (2pcs.)
Cod.CP082B

CP086B composed by 5 pieces including the new protection for Crankshaft Sensor (CP082B), the latest invention of Bonamici Racing, especially useful for use on track.

CP086B composto da 5 pezzi tra cui la nuova protezione per Sensore Albero Motore (CP082B), ultima invenzione di Bonamici Racing, particolarmente utile per l'utilizzo in pista.



BMW S 1000 XR (2020 / >) full kit (4 pcs.)
kit completo (4 pz.) - Cod.CP116



BMW S 1000 RR (2019 / >)
BMW M 1000 RR (2021 / >)
BMW S 1000 R (2021 / >)
full kit (5 pcs.) - kit completo (5 pz.) - Cod.CP086B



BMW S 1000 RR 2023
code CP086B

DUCATI

MODEL - MODELLO	DESCRIPTION - DESCRIZIONE	FROM - DAL	TO - AL	CODE - CODICE
959 Panigale	right side - lato DX	2016	2018	CP007
959 Panigale	left side - lato SX	2016	2018	CP008B
959 Panigale	full kit - kit completo	2016	2018	CP009B
1199/1299 Panigale	right side - lato DX	2012	2018	CP007
1199/1299 Panigale	left side - lato SX	2012	2018	CP008A
1199/1299 Panigale	full kit - kit completo	2012	2018	CP009A
Panigale V4/V4S	right side - lato DX	2018	2024	CP079
Panigale V4/V4S	left side - lato SX	2018	2024	CP080
Panigale V4/V4S	full kit - kit completo	2018	2024	CP081
Panigale V4R	right side - lato DX	2018	2024	CP079B
Panigale V4R	left side - lato SX	2018	2024	CP080
Panigale V4R	full kit - kit completo	2018	2024	CP081B
Panigale V2	right side - lato DX	2020	2024	CP007
Panigale V2	left side - lato SX	2020	2024	CP104
Panigale V2	full kit - kit completo	2020	2024	CP105
NEW Panigale V2 "Racing" *	right side - lato DX	2020	2024	CP120
NEW Panigale V2 "Racing" *	left side - lato SX	2020	2024	CP121
NEW Panigale V2 "Racing" *	full kit - kit completo	2020	2024	CP122
Streetfighter V4/V4S	right side - lato DX	2020	2022	CP101
Streetfighter V4/V4S	left side - lato SX	2020	2022	CP102
Streetfighter V4/V4S	full kit - kit completo	2020	2022	CP103
Streetfighter V4/V4S	right side - lato DX	2023	>	CP079
Streetfighter V4/V4S	left side - lato SX	2023	>	CP080
Streetfighter V4/V4S	full kit - kit completo	2023	>	CP081

* Installation is possible only on racing racing fairings - * L'installazione è possibile solo su carene racing



DUCATI PANIGALE V4 / V4S - full kit - kit completo - cod. CP081



STREETFIGHTER V4/V4S - full kit - kit completo (2020-2022) - cod. CP103



DUCATI 1199 / 1299 PANIGALE - full kit - kit completo - cod. CP009A

Ducati Prigale V2 (2020/2024)
Right side "Racing" - code CP120





Honda CBR1000RR-R Fireblade (2020/ >)
code CP100

Honda CBR1000RR-R Fireblade (2020/ >)
code CP100



HONDA

PRICES WITHOUT VAT - PREZZI IVA ESCLUSA

MODEL - MODELLO	DESCRIPTION - DESCRIZIONE	FROM - DAL	TO - AL	CODE - CODICE
CBR 1000RR-R Fireblade	right side (distrib.) - lato DX (distrib.)	2020	>	CP097
CBR 1000RR-R Fireblade	right side (clutch) - lato DX (frizione)	2020	>	CP098
CBR 1000RR-R Fireblade	left side - lato SX	2020	>	CP099
CBR 1000RR-R Fireblade	full kit - kit completo	2020	>	CP100

● HONDA CBR1000RR-R FIREBLADE - full kit - kit completo - cod. CP100

KAWASAKI

MODEL - MODELLO	DESCRIPTION - DESCRIZIONE	FROM - DAL	TO - AL	CODE - CODICE
ZX-10R	right side - lato DX	2011	>	CP010
ZX-10R	left side - lato SX	2011	>	CP011
ZX-10R	full kit - kit completo	2011	>	CP012



KTM

MODEL - MODELLO	DESCRIPTION - DESCRIZIONE	FROM - DAL	TO - AL	CODE - CODICE
890 Duke / 890 Duke R	right side (water pump) lato DX (pompa acqua.)	2020	2023	CP090
890 Duke / 890 Duke R	right side (clutch) - lato DX (frizione)	2020	2023	CP091B
890 Duke / 890 Duke R	left side - lato SX	2020	2023	CP092B
890 Duke / 890 Duke R	full kit - kit completo	2020	2023	CP093B
1290 Super Duke	right side - lato DX	2013	2019	CP058
1290 Super Duke	left side - lato SX	2013	2019	CP059
1290 Super Duke	full kit - kit completo	2013	2019	CP060
1290 Super Duke R	right side - lato DX	2020	2023	CP058
1290 Super Duke R	left side - lato SX	2020	2023	CP059
1290 Super Duke R	full kit - kit completo	2020	2023	CP060
NEW 1390 Super Duke R	right side - lato DX	2024	>	CP123
NEW 1390 Super Duke R	left side - lato SX	2024	>	CP059
NEW 1390 Super Duke R	full kit - kit completo	2024	>	CP124

KAWASAKI ZX-10R - full kit - kit completo - cod. CP012



KTM 890 DUKE - full kit - kit completo - cod. CP093B



KTM 1390 Super Duke (2024/ >) - code CP123



KTM 1390 Super Duke - full kit - kit completo - cod. CP124



Kawasaki ZX-10R (2011/>)
code CP012



TRIUMPH SPEED TRIPLE 1200 RR/RS - right side cod. CP117



● SUZUKI GSX-R 1000 - full kit - kit completo - cod. CP070



● TRIUMPH SEEP TRIPLE 1200 RR/RS - full kit - kit completo - cod. CP119

SUZUKI

MODEL - MODELLO	DESCRIPTION - DESCRIZIONE	FROM - DAL	TO - AL	CODE - CODICE
GSX-R 1000	right side (distrib.) - lato DX (distrib.)	2017	>	CP067
GSX-R 1000	right side (clutch) - lato DX (frizione)	2017	>	CP068
GSX-R 1000	left side - lato SX	2017	>	CP069
GSX-R 1000	full kit - kit completo	2017	>	CP070

TRIUMPH

MODEL - MODELLO	DESCRIPTION - DESCRIZIONE	FROM - DAL	TO - AL	CODE - CODICE
Street Triple 765 S/R/RS	right side (distrib.) - lato DX (distrib.)	2017	2022	CP071
Street Triple 765 S/R/RS	right side (clutch) - lato DX (frizione)	2017	2022	CP072
Street Triple 765 S/R/RS	left side - lato SX	2017	2022	CP073
Street Triple 765 S/R/RS	full kit - kit completo	2017	2022	CP074
Street Triple 765 R/RS/Moto 2	right side (distrib.) - lato DX (distrib.)	2023	>	CP071
Street Triple 765 R/RS/Moto 2	right side (clutch) - lato DX (frizione)	2023	>	CP072
Street Triple 765 R/RS/Moto 2	left side - lato SX	2023	>	CP073
Street Triple 765 R/RS/Moto 2	full kit - kit completo	2023	>	CP074
Speed Triple1200 RR/RS	right side - lato DX	2021	>	CP117
Speed Triple1200 RR/RS	left side - lato SX	2021	>	CP118
Speed Triple1200 RR/RS	full kit - kit completo	2021	>	CP119



TRIUMPH STREET TRIPLE 765 RS Moto2 - left side cod. CP073

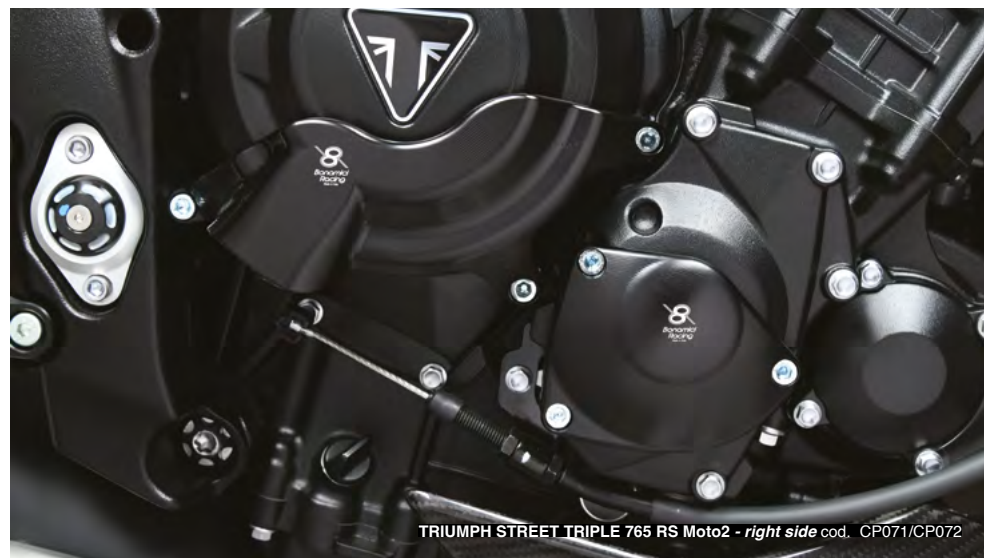

TRIUMPH STREET TRIPLE 765 RS Moto2 - right side cod. CP071/CP072

YAMAHA

MODEL - MODELLO	DESCRIPTION - DESCRIZIONE	FROM - DAL	TO - AL	CODE - CODICE
YZF R6	right side (distribution) - lato DX (distribuzione)	2006	>	CP022
YZF R6	right side (clutch) - lato DX (frizione)	2006	>	CP023
YZF R6	left side - lato SX	2006	>	CP024
YZF R6	full kit - kit completo	2006	>	CP025
YZF R1/R1M	right side (distribution) - lato DX (distribuzione)	2015	>	CP044
YZF R1/R1M	right side (clutch) - lato DX (frizione)	2015	>	CP045
YZF R1/R1M	left side - lato SX	2015	>	CP046
YZF R1/R1M	full kit - kit completo	2015	>	CP047



YAMAHA YZF R6 - full kit - kit completo - cod. CP025

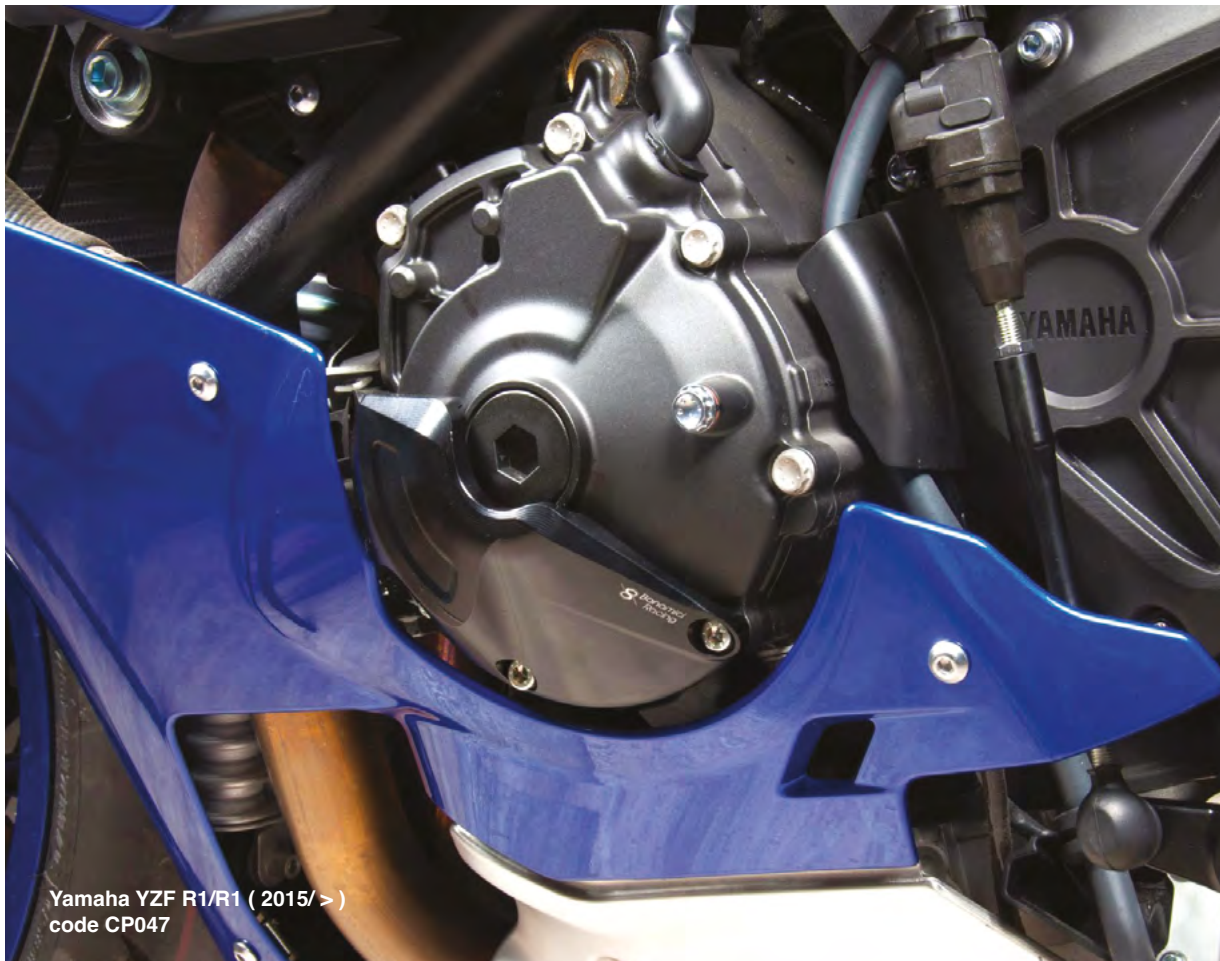

Yamaha YZF R1/R1 (2015/ >)
code CP047



YAMAHA YZF R1/R1M - full kit - kit completo - cod. CP047



Yamaha YZF R1/R1 (2015 / >)
code CP047

CUSTOMIZATION - PERSONALIZZAZIONE

- By purchasing a new kit it is possible to request the following customization services
- Acquistando un nuovo kit è possibile richiedere i seguenti accessori

DESCRIPTION - DESCRIZIONE

CODE - CODICE

Laser engravings (kit - 2 engravings) - Incisioni laser (kit - 2 incisioni)	KLS2
Extra colour - Colore extra	KK07

PRICES WITHOUT VAT - PREZZI IVA ESCLUSA



blue
blu



bronze
bronz



gold
oro



green
verde



orange
arancio



red
rosso



silver
argento





Our dash protection, news of 2019, born from the strong demand on racing protect the latest generation displays, sophisticated and precious devices. Made from special aluminum who can absorb shocks, with cnc machining, are resistant and safe, in addition, are equipped with an interchangeable Plexiglas protective panel with anti-fog system. Standard color black or silver, other colors on request.

Le protezioni strumentazione, prodotto novità 2019, nascono direttamente dall'uso agonistico per proteggere i display di ultima generazione, veri computer sofisticati e preziosi. Realizzate in alluminio con lavorazione cnc, sono resistentissime e dotate di un pannello protettivo in plexiglas intercambiabile con sistema antiappannamento. Colore standard nero, su richiesta è possibile averle in altri colori.



Ducati Streetfighter V2 (2022/ >)
code DCP11

Honda CBR1000RR-R Fireblade (2020/2023)
code DCP09



DUCATI PANIGALE V4 - cod. DCP03



BMW S 1000 RR / M1000RR / S 1000 R / S 1000 XR - cod. DCP08



HONDA CBR1000RR-R FIREBLADE - cod. DCP09

DASHBOARD PROTECTIONS - PROTEZIONI STRUMENTAZIONE

BRAND	MODEL - MODELLO	FROM - DAL	TO - AL	CODE - CODICE
Aprilia	RS 660 - Tuono 660	2020	>	DCP12
Aprilia	RSV4 Factory / Tuono V4/ Tuareg 660	2021	>	DCP13
Aprilia	RSV4 / Tuono V4	2017	2020	DCP06
BMW	S 1000 RR	2019	>	DCP08
BMW	M 1000 RR	2021	2022	DCP08
BMW	S 1000 R - M 1000 R	2021	>	DCP08
BMW	S 1000 XR	2020	>	DCP08
Ducati	Panigale V2	2020	2024	DCP11
Ducati	Streetfighter V2	2022	>	DCP11
Ducati	Panigale V4 / V4S / V4R	2018	2024	DCP03
Ducati	Streetfighter V4 / V4S	2020	>	DCP10
NEW Honda	CBR 600 RR	2024	>	DCP23
Honda	CBR 1000 RR-R Fireblade	2020	>	DCP09
Kawasaki	ZX-10R	2021	>	DCP20
Kawasaki	ZX-4R/RR	2023	>	DCP20
Kawasaki	Z 900	2020	>	DCP24
Suzuki	GSX-R 1000	2017	>	DCP05
Suzuki	GSX-S 1000	2021	>	DCP05
Yamaha	YZF R1 / R1M	2015	>	DCP04
Yamaha	YZF R7	2021	>	DCP16
I2M	Chrome lite - Chrome plus	-	-	DCP02
I2M	Chrome PRO 2	-	-	DCP19
ECUMASTER	ADU5 - REV1	2018	2020	DCP14
ECUMASTER	ADU5 - REV2	2021	>	DCP15
Aim	MXm	-	-	DCP17
Aim	Solo 2 - Solo 2 DL**	-	-	DCP18

SCREEN SPARE PART - VETRINO DI RICAMBIO

BRAND	MODEL - MODELLO	FROM - DAL	TO - AL	CODE - CODICE
Aprilia	RS 660 - Tuono 660	2020	>	SP_DCP12
Aprilia	RSV4 Factory / Tuono V4/ Tuareg 660	2021	>	SP_DCP13
Aprilia	RSV4 / Tuono V4	2017	2020	SP_DCP06
BMW	S 1000 RR	2019	>	SP_DCP08
BMW	M 1000 RR	2021	2022	SP_DCP08
BMW	S 1000 R - M 1000 R	2021	>	SP_DCP08
BMW	S 1000 XR	2020	>	SP_DCP08
Ducati	Panigale V2	2020	2024	SP_DCP11
Ducati	Streetfighter V2	2022	>	SP_DCP11
Ducati	Panigale V4 / V4S / V4R	2018	2024	SP_DCP03
Ducati	Streetfighter V4 / V4S	2020	>	SP_DCP10
NEW Honda	CBR 600 RR	2024	>	SP_DCP23
Honda	CBR 1000 RR-R Fireblade	2020	>	SP_DCP09
Kawasaki	ZX-10R	2021	>	SP_DCP20
Kawasaki	ZX-4R/RR	2023	>	SP_DCP20
Kawasaki	Z 900	2020	>	SP_DCP24
Suzuki	GSX-R 1000	2017	>	SP_DCP05
Suzuki	GSX-S 1000	2021	>	SP_DCP05
Yamaha	YZF R1 / R1M	2015	>	SP_DCP04
Yamaha	YZF R7	2021	>	SP_DCP16
I2M	Chrome lite - Chrome plus	-	-	SP_DCP02
I2M	Chrome PRO 2	-	-	SP_DCP19
ECUMASTER	ADU5 - REV1	2018	2020	SP_DCP14
ECUMASTER	ADU5 - REV2	2021	>	SP_DCP15
Aim	MXm	-	-	SP_DCP17
Aim	Solo 2 - Solo 2 DL	-	-	SP_DCP18

Colors available - Colori disponibili

Black



WARNING ATTENZIONE

(* It's possible to mount only with racing fairing - (*) Si può montare solo con le carene racing

(**) Fitting the dashboard protection may not make the GPS signal work - (**) Montando la cover potrebbe non funzionare il segnale GPS

All Bonamic Racing dashboard protectors are not waterproof.
Tutte le protezioni strumentazione Bonamic Racing non sono a tenuta stagna.



● APRILIA RSV4 FACTORY / TUONO V4 (2021) - cod. DCP06



● Aim MXm - cod. DCP17



● Aim Solo2 - cod. DCP18

TOP TRIPLE CLAMP - PIASTRE DI STERZO SUPERIORI

TOP TRIPLE CLAMP STREET VERSION
PIASTRE DI STERZO SUPERIORI VERSIONE STREET



TOP TRIPLE CLAMP RACE VERSION
PIASTRE DI STERZO SUPERIORI VERSIONE RACE

The range of top triple clamps is part of Bonamici Racing innovations for 2019 and stems from the experience gained in international competitions with high-level teams.

Made from solid billet aluminum with numerical control machines, with a modern and appealing design, they are the ideal product to improve performance and driving pleasure without increasing weight.

Two types: "Race" for use on the racetrack "Street" for the assembly of the original ignition block (where provided), no modification or adaptation is required on the stock-bike for assembly.

La gamma di piastre di sterzo superiori fa parte delle novità Bonamici Racing per il 2019 e nascono dall'esperienza maturata nelle competizioni mondiali in team di alto livello.

Realizzate in alluminio con lavorazione cnc, con un disegno moderno ed accattivante, sono il prodotto ideale per migliorare le performance ed il piacere di guida senza incrementare il peso. Due le tipologie: "Race" per l'impiego in pista e "Street" per il montaggio del blocchetto accensione originale (dove previsto), per il montaggio non è richiesta alcuna modifica o adattamento sulla moto di serie.



Ducati Panigale V4
code PSV4

TOP TRIPLE CLAMP - PIASTRE DI STERZO SUPERIORI

• Colors available • Colori disponibili



BRAND	MODEL - MODELLO	FROM - DAL	TO - AL	COLOUR - COLORE	CODE - CODICE
Aprilia	RS 660	2020	>	black - nero	PSA2
Aprilia	RS 660	2020	>	silver - argento	PSA2_SI
Aprilia	RSV4 - RSV4 Factory "Street"	2009	2014	black - nero	PSA1
		2019	>		
Aprilia	RSV4 - RSV4 Factory "Race" *	2009	2014	black - nero	PSA1R
		2019	>		
Aprilia	RSV4 - RSV4 Factory "Street"	2009	2014	silver - argento	PSA1_SI
		2019	>		
Aprilia	RSV4 - RSV4 Factory "Race" *	2009	2014	silver - argento	PSA1R_SI
		2019	>		
BMW	S 1000 RR "Street"	2015	2018	black - nero	PSB1
BMW	S 1000 RR "Race" *	2015	2018	black - nero	PSB1R
BMW	S 1000 RR "Street"	2015	2018	silver - argento	PSB1_SI
BMW	S 1000 RR "Race" *	2015	2018	silver - argento	PSB1R_SI
BMW	S 1000 RR "Street"	2019	2022	black - nero	PSB2
BMW	S 1000 RR "Race" *	2019	2022	black - nero	PSB2R
BMW	S 1000 RR "Street"	2019	2022	silver - argento	PSB2_SI
BMW	S 1000 RR "Race" *	2019	2022	silver - argento	PSB2R_SI
BMW	S 1000 RR "Street"	2023	>	black - nero	PSB3
BMW	S 1000 RR "Race" *	2023	>	black - nero	PSB3R
BMW	S 1000 RR "Street"	2023	>	silver - argento	PSB3_SI
BMW	S 1000 RR "Race" *	2023	>	silver - argento	PSB3R_SI
BMW	M 1000 RR "Street"	2021	>	black - nero	PSB3
BMW	M 1000 RR "Race" *	2021	>	black - nero	PSB3R
BMW	M 1000 RR "Street"	2021	>	silver - argento	PSB3_SI
BMW	M 1000 RR "Race" *	2021	>	silver - argento	PSB3R_SI
Ducati	Panigale V2	2020	2024	black - nero	PSV2
Ducati	Panigale V2	2020	2024	silver - argento	PSV2_SI
Ducati	Panigale V4/V4S	2018	2024	black - nero	PSV4
Ducati	Panigale V4/V4S	2018	2024	silver - argento	PSV4_SI
Ducati	Panigale V4R	2019	2022	black - nero	PSV4
Ducati	Panigale V4R	2019	2022	silver - argento	PSV4_SI
Honda	CBR 1000 RR "Street"	2017	2019	black - nero	PSH1
Honda	CBR 1000 RR "Race" *	2017	2019	black - nero	PSH1R
Honda	CBR 1000 RR "Street"	2017	2019	silver - argento	PSH1_SI
Honda	CBR 1000 RR "Race" *	2017	2019	silver - argento	PSH1R_SI
Honda	CBR 1000RR-R Fireblade	2020	>	black - nero	PSH2
Honda	CBR 1000RR-R Fireblade	2020	>	silver - argento	PSH2_SI

BRAND	MODEL - MODELLO	FROM - DAL	TO - AL	COLOUR - COLORE	CODE - CODICE
Kawasaki	ZX-10R "Street"	2016	2020	black - nero	PSK1
Kawasaki	ZX-10R "Race" *	2016	2020	black - nero	PSK1R
Kawasaki	ZX-10R "Street"	2016	2020	silver - argento	PSK1_SI
Kawasaki	ZX-10R "Race" *	2016	2020	silver - argento	PSK1R_SI
Kawasaki	ZX-10R "Street"	2021	>	black - nero	PSK3
Kawasaki	ZX-10R "Race" *	2021	>	black - nero	PSK3R
Kawasaki	ZX-10R "Street"	2021	>	silver - argento	PSK3_SI
Kawasaki	ZX-10R "Race" *	2021	>	silver - argento	PSK3R_SI
Kawasaki	ZX-4R/RR ***	2023	>	black - nero	PSK2
Kawasaki	ZX-4R/RR ***	2023	>	silver - argento	PSK2_SI
Suzuki	GSX-R 1000 "Street"	2017	>	black - nero	PSS1
Suzuki	GSX-R 1000 "Race" *	2017	>	black - nero	PSS1R
Suzuki	GSX-R 1000 "Street"	2017	>	silver - argento	PSS1_SI
Suzuki	GSX-R 1000 "Race" *	2017	>	silver - argento	PSS1R_SI
Triumph	Speed Triple 1200 RR **	2022	>	black - nero	PST1
Triumph	Speed Triple 1200 RR **	2022	>	silver - argento	PST1_SI
Yamaha	YZF R6 "Street"	2017	>	black - nero	PSY2
Yamaha	YZF R6 "Race" *	2017	>	black - nero	PSY2R
Yamaha	YZF R6 "Street"	2017	>	silver - argento	PSY2_SI
Yamaha	YZF R6 "Race" *	2017	>	silver - argento	PSY2R_SI
Yamaha	YZF R1/R1M "Street"	2015	>	black - nero	PSY1
Yamaha	YZF R1/R1M "Race" *	2015	>	black - nero	PSY1R
Yamaha	YZF R1/R1M "Street"	2015	>	silver - argento	PSY1_SI
Yamaha	YZF R1/R1M "Race" *	2015	>	silver - argento	PSY1R_SI
Yamaha	YZF R7 "Street"	2021	>	black - nero	PSY3
Yamaha	YZF R7 "Race" *	2021	>	black - nero	PSY3R
Yamaha	YZF R7 "Street"	2021	>	silver - argento	PSY3_SI
Yamaha	YZF R7 "Race" *	2021	>	silver - argento	PSY3R_SI

TOP TRIPLE CLAMP NUT - DADO PIASTRA DI STERZO SUPERIORE

MODEL - MODELLO	COLOUR - COLORE	CODE - CODICE
Yamaha YZF R7 (2021->)	black - nero	DD3_BK
Triumph Speed Triple 1200 RR (2022->)	black - nero	DD4_BK

WARNING ATTENZIONE

(*) is not possible to mount the OEM ignition switch key
 (*) non è possibile rimontare il blocchetto accensione originale
 (***) Equipped with the top tripleclamp plate nut, it is recommended to apply a light layer of grease when fitting the nut
 (***) Dotata del dado della piastra di sterzo, si consiglia al momento del montaggio del dado di applicare un leggero strato di grasso

(***) It is possible to use the top triple clamp in both Racing and Street mode as it is equipped with a removable support for the ignition lock
 (***) È possibile utilizzare la piastra sia in modalità Racing che Street perché dotata di supporto amovibile per il blocchetto di accensione.



• Triumph Speed Triple 1200 RR - code PST1



• BMW S 1000 RR "Street" (2023->) - code PSB3



• APRILIA RSV4 "STREET" - code PSA1



TRIUMPH SPEED TRIPLE 1200 RR
(2022/>) - code PST1



• DUCATI PANIGALE V4 -V4S-V4R (2018-2024) - code PSV4



- Titanium tightening screws on the forks
- Viti di serraggio sulle forcelle in titanio



The new range of brake and clutch lever controls has been redesigned to offer a better feeling of riding with your bike. Made of aluminum machined from solid with foldable lever, are equipped with a hole for air outflow who prevents the actuation if subject to the aerodynamic force. The new levers are more resistant and offer even more precise adjustment, moreover they have more excursion in order to adapt to any type of use. The final tilting part have a shape designed to offer the best grip and ergonomics. More shapes are available on request to satisfy every driving style.

La nuova gamma di comandi leva per freno e frizione è stata riprogettata per offrire un maggior feeling di guida con la propria moto. Realizzate in alluminio ricavate dal pieno con leva ribaltabile, sono dotate di foro per il deflusso aerodinamico che impedisce l'azionamento se soggette alla forza dell'aria. Le nuove leve sono più resistenti ed offrono una regolazione ancora più precisa e con più escursione in modo da adattarsi ad ogni tipo di utilizzo. Hanno inoltre la parte ribaltabile con una forma studiata per offrire la migliore presa ed ergonomia e sono disponibili su richiesta altre forme in modo da soddisfare ogni stile di guida.



APRILIA

MODEL - MODELLO	DESCRIPTION - DESCRIZIONE	FROM - DAL	TO - AL	CODE - CODICE
RSV4 - Factory - APRC	Levers kit - Kit leve	2009	>	KL010
RSV4 - Factory - APRC	Brake lever - Leva freno	2009	>	LB110
RSV4 - Factory - APRC	Clutch lever - Leva frizione	2009	>	LC010
Tuono 1100	Levers kit - Kit leve	2017	>	KL010
Tuono 1100	Brake lever - Leva freno	2017	>	LB110
Tuono 1100	Clutch lever - Leva frizione	2017	>	LC010
RS 660 - Tuono 660	Levers kit - Kit leve	2020	>	KL010
RS 660 - Tuono 660	Brake lever - Leva freno	2020	>	LB110
RS 660 - Tuono 660	Clutch lever - Leva frizione	2020	>	LC010
Tuareg 660	Levers kit - Kit leve	2021	>	KL370
Tuareg 660	Brake lever - Leva freno	2021	>	LB230
Tuareg 660	Clutch lever - Leva frizione	2021	>	LC010



APRILIA RSV4 - FACTORY - APRC - Levers kit - Kit leve - cod. KL010

BMW

MODEL - MODELLO	DESCRIPTION - DESCRIZIONE	FROM - DAL	TO - AL	CODE - CODICE
S 1000 RR - HP4	Levers kit - Kit leve	2008	2014	KL020
S 1000 RR - HP4	Brake lever - Leva freno	2008	2014	LB090
S 1000 RR - HP4	Clutch lever - Leva frizione	2008	2014	LC070
S 1000 RR	Levers kit - Kit leve	2015	2018	KL220
S 1000 RR	Brake lever - Leva freno	2015	2018	LB090
S 1000 RR	Clutch lever - Leva frizione	2015	2018	LC140
S 1000 RR - M 1000 RR * **	Levers kit - Kit leve	2019	>	KL290
S 1000 RR - M 1000 RR *	Brake lever - Leva freno	2019	>	LB090
S 1000 RR - M 1000 RR **	Clutch lever - Leva frizione	2019	>	LC170
S 1000 R	Levers kit - Kit leve	2012	2020	KL220
S 1000 R	Brake lever - Leva freno	2012	2020	LB090
S 1000 R	Clutch lever - Leva frizione	2012	2020	LC140
S 1000 R - M 1000 R **	Levers kit - Kit leve	2021	>	KL270
S 1000 R - M 1000 R	Brake lever - Leva freno	2021	>	LB200
S 1000 R - M 1000 R **	Clutch lever - Leva frizione	2021	>	LC170
S 1000 XR **	Levers kit - Kit leve	2020	>	KL270
S 1000 XR	Brake lever - Leva freno	2020	>	LB200
S 1000 XR **	Clutch lever - Leva frizione	2020	>	LC170



BMW S 1000 RR (2019/>) - Levers kit - Kit leve - cod. KL290



BMW S 1000 R (2021) - Levers kit - Kit leve - cod. KL270

(*) The brake lever may touch with the knob on the instrument frame, when the motorcycle is understeer.

(**) The plastic protection cannot be remounted on the clutch lever.

(*) La leva freno quando la moto è sottosterzo, potrebbe toccare con il pomello sul telaio porta strumentazione.

(**) Non è possibile rimontare la protezione in plastica sulla leva frizione.



BMW S 1000 RR 2023
Brake lever - code LB090

Ducati Panigale V4 (2023 />)
Brake lever - code LB240

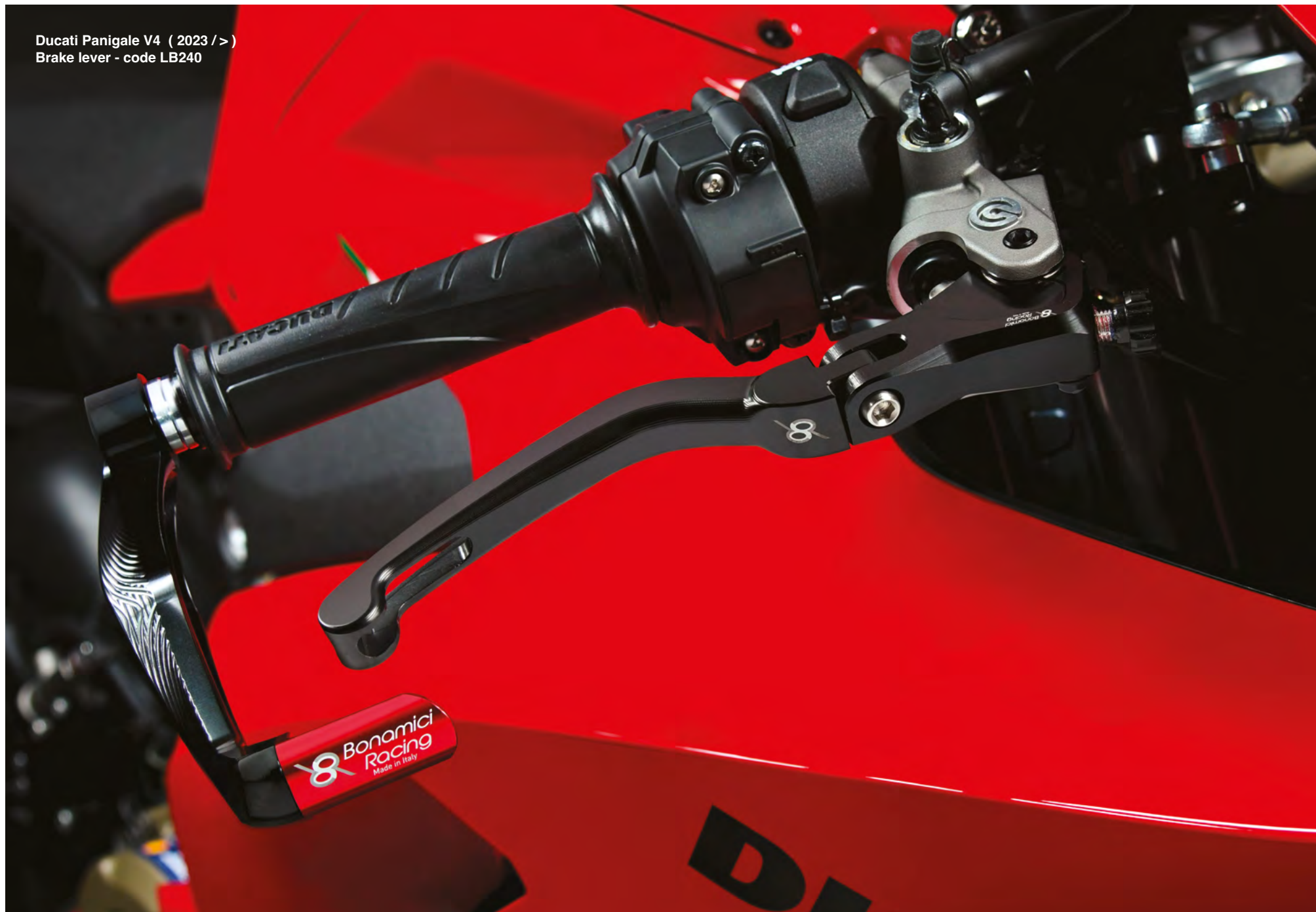



● **DUCATI Levers kit - Kit leve - cod. KL031**



Multistrada V4 (2020/>)

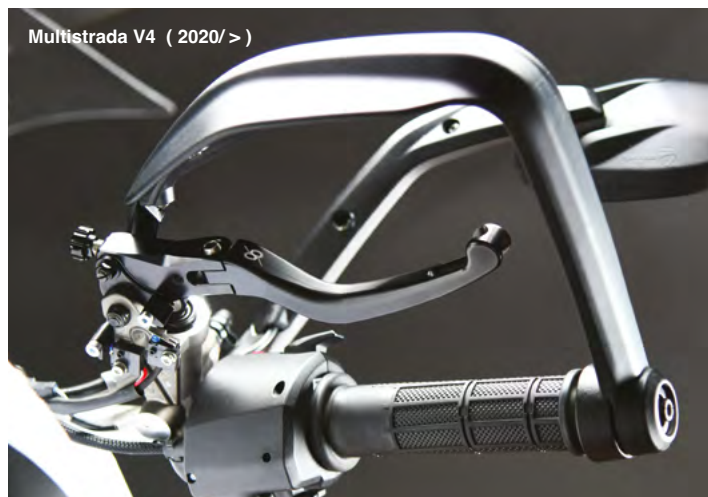

Multistrada V4 (2020/>)

DUCATI

MODEL - MODELLO	DESCRIPTION - DESCRIZIONE	FROM - DAL	TO - AL	CODE - CODICE
Monster 1100	Levers kit - Kit leve	2010	2016	KL031
Monster 1100	Brake lever - Leva freno	2010	2016	LB140
Monster 1100	Clutch lever - Leva frizione	2010	2016	LC061
Monster 1200	Levers kit - Kit leve	2014	2018	KL031
Monster 1200	Brake lever - Leva freno	2014	2018	LB140
Monster 1200	Clutch lever - Leva frizione	2014	2018	LC061
749/999	Levers kit - Kit leve	2002	2006	KL031
749/999	Brake lever - Leva freno	2002	2006	LB140
749/999	Clutch lever - Leva frizione	2002	2006	LC061
848/1098/1198	Levers kit - Kit leve	2007	2012	KL031
848/1098/1198	Brake lever - Leva freno	2007	2012	LB140
848/1098/1198	Clutch lever - Leva frizione	2007	2012	LC061
Panigale V2 899 - 959 - 1199 - 1299 Panigale	Levers kit - Kit leve	2012	2022	KL031
Panigale V2 899 - 959 - 1199 - 1299 Panigale	Brake lever - Leva freno	2012	2022	LB140
Panigale V2 899 - 959 - 1199 - 1299 Panigale	Clutch lever - Leva frizione	2012	2022	LC061
Panigale V2	Levers kit - Kit leve	2023	>	KL380
Panigale V2	Brake lever - Leva freno	2023	>	LB240
Panigale V2	Clutch lever - Leva frizione	2023	>	LC061
Panigale V4 / V4S / V4R	Levers kit - Kit leve	2018	2022	KL031
Panigale V4 / V4S / V4R	Brake lever - Leva freno	2018	2022	LB140
Panigale V4 / V4S / V4R	Clutch lever - Leva frizione	2018	2022	LC061
Panigale V4 / V4S / V4R	Levers kit - Kit leve	2023	>	KL380
Panigale V4 / V4S / V4R	Brake lever - Leva freno	2023	>	LB240
Panigale V4 / V4S / V4R	Clutch lever - Leva frizione	2023	>	LC061
Streetfighter 848 / 1100	Levers kit - Kit leve	2009	2016	KL031
Streetfighter 848 / 1100	Brake lever - Leva freno	2009	2016	LB140
Streetfighter 848 / 1100	Clutch lever - Leva frizione	2009	2016	LC061
Streetfighter V2	Levers kit - Kit leve	2022	>	KL380
Streetfighter V2	Brake lever - Leva freno	2022	>	LB240
Streetfighter V2	Clutch lever - Leva frizione	2022	>	LC061
Streetfighter V4 / V4S	Levers kit - Kit leve	2020	2022	KL031
Streetfighter V4 / V4S	Brake lever - Leva freno	2020	2022	LB140
Streetfighter V4 / V4S	Clutch lever - Leva frizione	2020	2022	LC061
Streetfighter V4 / V4S	Levers kit - Kit leve	2023	>	KL380
Streetfighter V4 / V4S	Brake lever - Leva freno	2023	>	LB240
Streetfighter V4 / V4S	Clutch lever - Leva frizione	2023	>	LC061
Multistrada V2 / V2S	Levers kit - Kit leve	2021	>	KL032
Multistrada V2 / V2S	Brake lever - Leva freno	2021	>	LB141
Multistrada V2 / V2S	Clutch lever - Leva frizione	2021	>	LC062
Multistrada V4 V4S / V4S Sport / V4 Pikes Peak	Levers kit - Kit leve	2020	>	KL380
Multistrada V4 V4S / V4S Sport / V4 Pikes Peak	Brake lever - Leva freno	2020	>	LB240
Multistrada V4 V4S / V4S Sport / V4 Pikes Peak	Clutch lever - Leva frizione	2020	>	LC061

HONDA

MODEL - MODELLO	DESCRIPTION - DESCRIZIONE	FROM - DAL	TO - AL	CODE - CODICE
CBR 600 RR	Levers kit - Kit leve	2007	>	KL040
CBR 600 RR	Brake lever - Leva freno	2007	>	LB150
CBR 600 RR	Clutch lever - Leva frizione	2007	>	LC020
CBR 1000 RR	Levers kit - Kit leve	2008	2019	KL040
CBR 1000 RR	Brake lever - Leva freno	2008	2019	LB150
CBR 1000 RR	Clutch lever - Leva frizione	2008	2019	LC020
CBR 1000 RR-R Fireblade	Levers kit - Kit leve	2020	>	KL040
CBR 1000 RR-R Fireblade	Brake lever - Leva freno	2020	>	LB150
CBR 1000 RR-R Fireblade	Clutch lever - Leva frizione	2020	>	LC020
CBR 1000 RR-R Fireblade SP	Levers kit - Kit leve	2020	>	KL310
CBR 1000 RR-R Fireblade SP	Brake lever - Leva freno	2020	>	LB110
CBR 1000 RR-R Fireblade SP	Clutch lever - Leva frizione	2020	>	LC020



HONDA CBR1000RR-R FIREBLADE SP
Levers kit - Kit leve - cod. KL310



Honda CBR1000RR-R Fireblade (2020/>)
Brake lever - code LB150



KAWASAKI ZX-4R/RR - Z 900
Levers kit - Kit leve - cod. KL410



KAWASAKI ZX-10R (2016 ->)
Levers kit - Kit leve - cod. KL210



KTM 790 DUKE - Levers kit - Kit leve - cod. KL300

KAWASAKI

MODEL - MODELLO	DESCRIPTION - DESCRIZIONE	FROM - DAL	TO - AL	CODE - CODICE
Ninja 300 (ZX-3R)	Levers kit - Kit leve	2014	2017	KL260
Ninja 300 (ZX-3R)	Brake lever - Leva freno	2014	2017	LB180
Ninja 300 (ZX-3R)	Clutch lever - Leva frizione	2014	2017	LC160
Ninja 250/400	Levers kit - Kit leve	2018	2023	KL260
Ninja 250/400	Brake lever - Leva freno	2018	2023	LB180
Ninja 250/400	Clutch lever - Leva frizione	2018	2023	LC160
ZX-4R/RR	Levers kit - Kit leve	2023	>	KL410
ZX-4R/RR	Brake lever - Leva freno	2023	>	LB260
ZX-4R/RR	Clutch lever - Leva frizione	2023	>	LC240
ZX-6R - ZX-6R 636	Levers kit - Kit leve	2005	2017	KL110
ZX-6R - ZX-6R 636	Brake lever - Leva freno	2005	2017	LB160
ZX-6R - ZX-6R 636	Clutch lever - Leva frizione	2005	2017	LC040
ZX-10R	Levers kit - Kit leve	2006	2015	KL110
ZX-10R	Brake lever - Leva freno	2006	2015	LB160
ZX-10R	Clutch lever - Leva frizione	2006	2015	LC040
ZX-10R	Levers kit - Kit leve	2016	>	KL210
ZX-10R	Brake lever - Leva freno	2016	>	LB110
ZX-10R	Clutch lever - Leva frizione	2016	>	LC040
Z 900	Levers kit - Kit leve	2017	>	KL410
Z 900	Brake lever - Leva freno	2017	>	LB260
Z 900	Clutch lever - Leva frizione	2017	>	LC240

KTM

MODEL - MODELLO	DESCRIPTION - DESCRIZIONE	FROM - DAL	TO - AL	CODE - CODICE	€
790/890 Duke	Levers kit - Kit leve	2018	2023	KL300	260,00
790/890 Duke	Brake lever - Leva freno	2018	2023	LB190	146,00
790/890 Duke	Clutch lever - Leva frizione	2018	2023	LC180	130,00
890 Duke R	Levers kit - Kit leve	2021	2023	KL320	260,00
890 Duke R	Brake lever - Leva freno	2021	2023	LB210	146,00
890 Duke R	Clutch lever - Leva frizione	2021	2023	LC180	130,00
1290 Super Duke R	Levers kit - Kit leve	2020	2023	KL280	260,00
1290 Super Duke R	Brake lever - Leva freno	2020	2023	LB110	146,00
1290 Super Duke R	Clutch lever - Leva frizione	2020	2023	LC200	130,00
NEW 1390 Super Duke R	Levers kit - Kit leve	2024	>	KL420	273,00
1390 Super Duke R	Brake lever - Leva freno	2024	>	LB210	146,00
1390 Super Duke R	Clutch lever - Leva frizione	2024	>	LC061	143,00

MV AGUSTA

MODEL - MODELLO	DESCRIPTION - DESCRIZIONE	FROM - DAL	TO - AL	CODE - CODICE	€
F3 675/ F3 800	Levers kit - Kit leve	2011	>	KL200	247,00
F3 675/ F3 800	Brake lever - Leva freno	2011	>	LB090	146,00
F3 675/ F3 800	Clutch lever - Leva frizione	2011	>	LC110	116,00



Triumph Street Triple 765 Moto 2 Edition (2023/ >) clutch lever - code LC230

SUZUKI



● **SUZUKI GSX-R 1000 - Levers kit - Kit leve** - cod. KL170



NEW

NEW

MODEL - MODELLO	DESCRIPTION - DESCRIZIONE	FROM - DAL	TO - AL	CODE - CODICE
GSX-R 600/ GSX-R 750	Levers kit - Kit leve	2006	2010	KL120
GSX-R 600/ GSX-R 750	Brake lever - Leva freno	2006	2010	LB090
GSX-R 600/ GSX-R 750	Clutch lever - Leva frizione	2006	2010	LC010
GSX-R 600/ GSX-R 750	Levers kit - Kit leve	2011	2017	KL170
GSX-R 600/ GSX-R 750	Brake lever - Leva freno	2011	2017	LB090
GSX-R 600/ GSX-R 750	Clutch lever - Leva frizione	2011	2017	LC090
GSX-R 1000	Levers kit - Kit leve	2005	2006	KL120
GSX-R 1000	Brake lever - Leva freno	2005	2006	LB090
GSX-R 1000	Clutch lever - Leva frizione	2005	2006	LC010
GSX-R 1000	Levers kit - Kit leve	2009	2010	KL120
GSX-R 1000	Brake lever - Leva freno	2009	2010	LB090
GSX-R 1000	Clutch lever - Leva frizione	2009	2010	LC010
GSX-R 1000	Levers kit - Kit leve	2011	>	KL170
GSX-R 1000	Brake lever - Leva freno	2011	>	LB090
GSX-R 1000	Clutch lever - Leva frizione	2011	>	LC090
GSX-S 1000	Levers kit - Kit leve	2021	>	KL330
GSX-S 1000	Brake lever - Leva freno	2021	>	LB201
GSX-S 1000	Clutch lever - Leva frizione	2021	>	LC210
NEW GSX-8S/8R	Levers kit - Kit leve	2023	>	KL430
NEW GSX-8S/8R	Brake lever - Leva freno	2023	>	LB201
NEW GSX-8S/8R	Clutch lever - Leva frizione	2023	>	LC250

TRIUMPH

● **TRIUMPH STREET TRIPLE 765 R - Levers kit - Kit leve** - cod. KL390



● **TRIUMPH SPEED TRIPLE 1200 RR/RS - Levers kit - Kit leve** - cod. KL360

MODEL - MODELLO	DESCRIPTION - DESCRIZIONE	FROM - DAL	TO - AL	CODE - CODICE
Daytona 675 R	Levers kit - Kit leve	2011	2016	KL180
Daytona 675 R	Brake lever - Leva freno	2011	2016	LB110
Daytona 675 R	Clutch lever - Leva frizione	2011	2016	LC080
Daytona 675	Clutch lever - Leva frizione	2011	2016	LC080
Speed Triple 1050/1050 R	Levers kit - Kit leve	2011	2017	KL180
Speed Triple 1050/1050 R	Brake lever - Leva freno	2011	2017	LB110
Speed Triple 1050/1050 R	Clutch lever - Leva frizione	2011	2017	LC080
Street Triple 765 R	Levers kit - Kit leve	2023	>	KL390
Street Triple 765 R	Brake lever - Leva freno	2023	>	LB200
Street Triple 765 R	Clutch lever - Leva frizione	2023	>	LC080
Street Triple 765 RS/Moto 2	Levers kit - Kit leve	2023	>	KL360
Street Triple 765 RS/Moto 2	Brake lever - Leva freno	2023	>	LB210
Street Triple 765 RS/Moto 2	Clutch lever - Leva frizione	2023	>	LC230
Speed Triple 1200 RR/RS	Levers kit - Kit leve	2021	>	KL360
Speed Triple 1200 RR/RS	Brake lever - Leva freno	2021	>	LB210
Speed Triple 1200 RR/RS	Clutch lever - Leva frizione	2021	>	LC230

YAMAHA

MODEL - MODELLO	DESCRIPTION - DESCRIZIONE	FROM - DAL	TO - AL	CODE - CODICE
YZF R3	Levers kit - Kit leve	2015	>	KL250
YZF R3	Brake lever - Leva freno	2015	>	LB170
YZF R3	Clutch lever - Leva frizione	2015	>	LC150
YZF R6	Levers kit - Kit leve	2006	2016	KL240
YZF R6	Brake lever - Leva freno	2006	2016	LB140
YZF R6	Clutch lever - Leva frizione	2006	2016	LC010
YZF R6	Levers kit - Kit leve	2017	>	KL230
YZF R6	Brake lever - Leva freno	2017	>	LB100
YZF R6	Clutch lever - Leva frizione	2017	>	LC010
YZF R1	Levers kit - Kit leve	2004	2014	KL240
YZF R1	Brake lever - Leva freno	2004	2014	LB140
YZF R1	Clutch lever - Leva frizione	2004	2014	LC010
YZF R1/R1M	Levers kit - Kit leve	2015	>	KL231
YZF R1/R1M	Brake lever - Leva freno On this lever is not possible mount the remote adjuster. The lever with remote adjuster for YZF R1 '15/'20 has code RALB100. Su questa leva non è possibile montare il registro remoto. L'unica leva con registro remoto utilizzabile sulla YZF R1 '15/> è quella con codice RALB100	2015	>	LB101
YZF R1/R1M	Clutch lever - Leva frizione	2015	>	LC010
YZF R7	Levers kit - Kit leve	2021	>	KL340
YZF R7	Brake lever - Leva freno It can only be mounted on Bonamici Racing handlebars Code SM50B Può essere montata solo sui semimanubri Bonamici Racing Codice SM50B	2021	>	LB220
YZF R7	Clutch lever - Leva frizione	2021	>	LC010
MT-09	Levers kit - Kit leve	2021	2023	KL231
MT-09	Brake lever - Leva freno	2021	2023	LB101
MT-09	Clutch lever - Leva frizione	2021	2023	LC010



YAMAHA YZF R6 2017 - Levers kit - Kit leve - cod. KL230



YAMAHA YZF R1/R1M - Levers kit - Kit leve - cod. KL231

BREMBO

MODEL - MODELLO	DESCRIPTION - DESCRIZIONE	FROM - DAL	TO - AL	CODE - CODICE
16 X 18 - 19 X 18	Brake lever - Leva freno	-	-	LB070
19 X 20	Brake lever - Leva freno	-	-	LB080
RCS	Brake lever - Leva freno Aluminium half lever Solo la parte terminale in alluminio	-	-	LB120
Racing	Brake lever - Leva freno Aluminium half lever Solo la parte terminale in alluminio	-	-	LB120R
Corsa Corta	Brake lever - Leva freno Aluminium half lever Solo la parte terminale in alluminio	-	-	LB120CC
MCS	Brake lever - Leva freno	-	-	LB210



BREMBO CORSA CORTA - Brake lever - Leva freno - cod. LB120CC



Yamaha YZF R1/R1M (2015/>)
code KL231

FULL CLUTCH LEVERS - LEVE FRIZIONE COMPLETE



ADJUSTABLE - REGOLABILE

DESCRIPTION - DESCRIZIONE CODE - CODICE

Offset 24mm	LCFR24
Offset 27mm	LCFR27
Offset 29mm	LCFR29
Offset 32mm	LCFR32
Offset 34mm	LCFR34

NOT ADJUSTABLE - NON REGOLABILE

DESCRIPTION - DESCRIZIONE CODE - CODICE

Offset 24mm	LCF24
Offset 27mm	LCF27
Offset 29mm	LCF29
Offset 32mm	LCF32
Offset 34mm	LCF34

WARNING ATTENZIONE

Product for racing use only, it is not possible to install the (OEM) switch
Prodotto esclusivamente per uso racing, non è possibile installare lo switch di serie

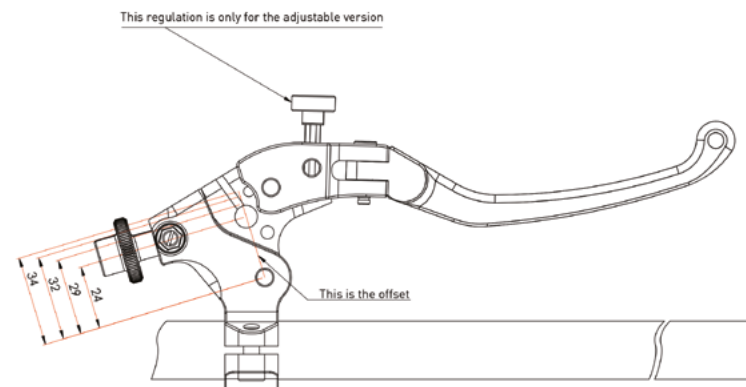

NOTES - NOTE

HOW TO CHOSE THE OFFSET

At the purchase time it is necessary to choose the ideal offset keeping in mind the following: greater is the offset, greater will be the hardness of the lever with a faster detachment. To determine the offset of the original lever, perform the measurement as in the picture.

COME SCEGLIERE L'OFFSET

Al momento dell'acquisto occorre scegliere l'offset ideale tenendo presente che maggiore è l'offset e maggiore sarà la durezza della leva con uno stacco più rapido.
Per stabilire l'offset della leva originale eseguire la misurazione come in foto





BRAKE LEVERS WITH REMOTE ADJUSTER - LEVE FRENO CON REGISTRO REMOTO



BRAKE LEVERS WITH RACING REMOTE ADJUSTER
LEVE FRENO CON REGISTRO REMOTO RACING



BRAKE LEVERS WITH REMOTE ADJUSTER
LEVE FRENO CON REGISTRO REMOTO

BRAND	MODEL - MODELLO	FROM - DAL	TO - AL	CODE - CODICE	
				Standard version	Racing version
Aprilia	RS 660 - TUONO 660	2020	>	RALB110	RALB110R
Aprilia	RSV4 - Factory - APRC	2009	>	RALB110	RALB110R
Aprilia	Tuono 1100	2017	2020	RALB110	RALB110R
BMW	S 1000 R	2012	2020	RALB090	RALB090R
BMW	S 1000 R - M 1000 R	2021	>	RALB200	RALB200R
BMW	S 1000 RR - M 1000 RR - HP4	2008	>	RALB090	RALB090R
Ducati	749/999	2002	2006	RALB140	RALB140R
Ducati	848/1098/1198	2007	2012	RALB140	RALB140R
Ducati	899/1199/1299 Panigale/V2	2012	>	RALB140	RALB140R
Ducati	Streetfighter V2	2022	>	RALB240	RALB240R
Ducati	Streetfighter V4	2020	2022	RALB140	RALB140R
Ducati	Streetfighter V4	2023	>	RALB240	RALB240R
Ducati	Panigale V4/V4S/V4R	2018	2022	RALB140	RALB140R
Ducati	Panigale V2/V4/V4S/V4R	2023	>	RALB240	RALB240R
Honda	CBR 500 R - CB 500 F	2019	>	RALB180	RALB180R
Honda	CBR 600 RR	2007	>	RALB150	RALB150R
Honda	CBR 1000 RR	2004	2019	RALB150	RALB150R
Honda	CBR 1000 RR-R Fireblade	2020	>	RALB150	RALB150R
Honda	CBR 1000 RR-R Fireblade SP	2020	>	RALB110	RALB110R
Kawasaki	Ninja 300 (ZX-3R)	2014	2017	RALB180	RALB180R
Kawasaki	Ninja 250/400	2018	2023	RALB180	RALB180R
Kawasaki	ZX-4R/RR	2023	>	RALB260	RALB260R
Kawasaki	Z 900	2017	>	RALB260	RALB260R
Kawasaki	ZX-6R	2005	2017	RALB160	RALB160R
Kawasaki	ZX-10R	2006	2015	RALB160	RALB160R
Kawasaki	ZX-10R	2016	>	RALB110	RALB110R
KTM	790 / 890 Duke	2018	2023	RALB190	RALB190R
KTM	890 Duke R	2021	2023	RALB210	RALB210R
KTM	1290 Super Duke R	2020	2023	RALB110	RALB110R
KTM	1390 Super Duke R	2024	>	RALB210	RALB210R
MV Agusta	F3 675/800	2011	>	RALB090	RALB090R
Suzuki	GSX-R 600/750/1000	2004	>	RALB090	RALB090R
Suzuki	GSX-S 1000 / GSX 8R-8S	2021	>	RALB201	RALB201R
Triumph	Daytona 675 R	2011	2016	RALB110	RALB110R
Triumph	Speed triple 1200 RR/RS	2021	>	RALB210	RALB210R
Triumph	Street triple 765 R	2023	>	RALB200	RALB200R
Triumph	Street triple 765 RS/Moto 2	2023	>	RALB210	RALB210R
Yamaha	YZF R3	2015	>	RALB170	RALB170R
Yamaha	YZF R6	2006	2016	RALB140	RALB140R
Yamaha	YZF R6	2017	>	RALB100	RALB100R
Yamaha	YZF R1	2004	2014	RALB140	RALB140R
Yamaha	YZF R1/R1M	2015	>	RALB100	RALB100R
Yamaha	YZF R7	2021	>	RALB220	RALB220R
Brembo	16x18	-	-	RALB070	RALB070R
Brembo	19x18	-	-	RALB070	RALB070R
Brembo	19x20	-	-	RALB080	RALB080R
Brembo	MCS	-	-	RALB210	RALB210R

REMOTE ADJUSTER - REGISTRO REMOTO

MODEL - MODELLO

CODE - CODICE

Cable length 52,5 mm - Lunghezza cavo 52,5 mm	00BRC
Cable length 75,5 mm - Lunghezza cavo 77,5 mm	00BRL
Braking	0042
Brembo original pump - Brembo pompa di serie	0037
Brembo 16x18/19x18/19x20	0037R
Brembo RCS/RCS Corsa Corta	0043
Discacciati	0038
PT	0041

BRAKE LEVER ATTACHMENT - ATTACCO LEVA FRENO

Code 00BRC
Code 00BRL

Code 0037R

Code 0043

Code 0037

Code 0038
Code 0041
Code 0042



RACING REMOTE ADJUSTER - REGISTRO REMOTO RACING

MODEL - MODELLO

CODE - CODICE

Cable length 52.5 mm - Lunghezza cavo 52,5 mm	RRP_BRC
Cable length 77.5 mm - Lunghezza cavo 77,5 mm	RRP_BRL
Brembo original pump - Brembo pompa di serie	RRP_37
Brembo 16x18/19x18/19x20	RRP_37R
Brembo RCS/RCS Corsa Corta	RRP_43

BRAKE LEVER ATTACHMENT - ATTACCO LEVA FRENO

Code RRP_BRC
Code RRP_BRL

Code RRP_37R

Code RRP_43

Code RRP_37



SPARE PARTS REMOTE ADJUSTER - RICAMBI REGISTRO REMOTO

DESCRIPTION - DESCRIZIONE

CODE - CODICE

Bracelet + joint for remote adjuster racing - Bracciale + Snodo per registro remoto racing	REGBR
Bracelet + joint for remote adjuster standard - Bracciale + Snodo per registro remoto standard	REGBS
Knob for remote adjuster - Pomello per registro remoto	REGPO
Knob for remote adjuster Racing - Pomello per registro remoto Racing	RRP4
Short cable (52,5cm) for remote adjuster - Cavo corto (52,5cm) per registro remoto	REGCC
Long cable (77,5cm) for remote adjuster - Cavo lungo (77,5cm) per registro remoto	REGCL
Adjuster connection for Bonamici levers - Attacco registro remoto per leve Bonamici	00BRA
Adjuster connection for Brembo OEM - Attacco registro remoto per Brembo di serie	0037A
Adjuster connection for Brembo 16x18 - 19x18 - 19x20 Attacco registro remoto per Brembo 16x18 - 19x18 - 19x20	0037RA
Adjuster connection for Brembo RCS - Attacco registro remoto per Brembo RCS	0043RA
Adjuster connection for Discacciati / PT / Braking Attacco registro remoto per Discacciati / PT / Braking	0038A



LEVERS ACCESSORIES AND SPARE PARTS - ACCESSORI E RICAMBI LEVE

The entire Bonamici Racing lever range is supplied with the half lever in the "standard" version code LL05 in black. When purchasing it is possible to request the LL05 lever in different colors at no extra charge and laser engraving as an option. The levers in the "Straight" version code LL03 and in the "Racing" version code LL04 can be purchased separately as spare parts and are only available in black.

LEVERS ACCESSORIES - ACCESSORI LEVE

DESCRIPTION - DESCRIZIONE	COLOUR- COLORE	CODE - CODICE
Colour for Bonamici Racing levers kit Colore per kit leve Bonamici Racing	blue - blu	KLC_BL
Colour for Bonamici Racing levers kit Colore per kit leve Bonamici Racing	green - verde	KLC_GR
Colour for Bonamici Racing levers kit Colore per kit leve Bonamici Racing	gold - oro	KLC_GO
Colour for Bonamici Racing levers kit Colore per kit leve Bonamici Racing	orange - arancio	KLC_OR
Colour for Bonamici Racing levers kit Colore per kit leve Bonamici Racing	red - rosso	KLC_RE
Colour for Bonamici Racing levers kit Colore per kit leve Bonamici Racing	silver - argento	KLC_SI
Colour for Bonamici Racing levers kit Colore per kit leve Bonamici Racing	bronze - bronzo	KLC_BR

DESCRIPTION - DESCRIZIONE	COLOUR- COLORE	CODE - CODICE
Color for Bonamici Racing single lever Colore per leva singola Bonamici Racing	blue - blu	LLC_BL
Color for Bonamici Racing single lever Colore per leva singola Bonamici Racing	green - verde	LLC_GR
Color for Bonamici Racing single lever Colore per leva singola Bonamici Racing	gold - oro	LLC_GO
Color for Bonamici Racing single lever Colore per leva singola Bonamici Racing	orange - arancio	LLC_OR
Color for Bonamici Racing single lever Colore per leva singola Bonamici Racing	red - rosso	LLC_RE
Color for Bonamici Racing single lever Colore per leva singola Bonamici Racing	silver - argento	LLC_SI
Color for Bonamici Racing single lever Colore per leva singola Bonamici Racing	bronze - bronzo	LLC_BR

LEVERS SPARE PARTS - RICAMBI LEVE

DESCRIPTION - DESCRIZIONE	COLOUR- COLORE	CODE - CODICE
Aluminium half lever "Standard"(RH/LH) Leva in alluminio "Standard"(DX/SX)	black - nero	LL05_BK
Aluminium half lever "Standard"(RH/LH) Leva in alluminio "Standard"(DX/SX)	blue - blu	LL05_BL
Aluminium half lever "Standard"(RH/LH) Leva in alluminio "Standard"(DX/SX)	green - verde	LL05_GR
Aluminium half lever "Standard"(RH/LH) Leva in alluminio "Standard"(DX/SX)	gold - oro	LL05_GO
Aluminium half lever "Standard"(RH/LH) Leva in alluminio "Standard"(DX/SX)	orange - arancio	LL05_OR
Aluminium half lever "Standard"(RH/LH) Leva in alluminio "Standard"(DX/SX)	red - rosso	LL05_RE
Aluminium half lever "Standard"(RH/LH) Leva in alluminio "Standard"(DX/SX)	silver - argento	LL05_SI
Aluminium half lever "Standard"(RH/LH) Leva in alluminio "Standard"(DX/SX)	bronze - bronzo	LL05_BR

L'intera gamma leve Bonamici Racing è fornita con la parte finale della leva nella versione "Standard" codice LL05 di colore nero, al momento dell'acquisto è possibile richiedere la leva LL05 in diversi colori senza sovrapprezzo ed incisione laser come optional. Le leve nella versione "Dritta" codice LL03 e nella versione "Racing" codice LL04 sono acquistabili separatamente come ricambio ed è disponibili solo di colore nero.

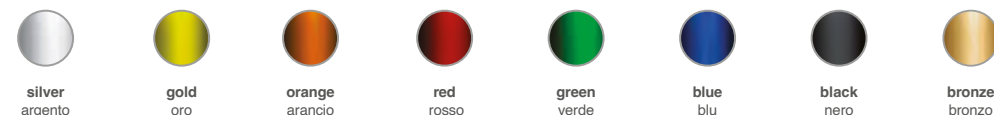

Colour for half lever - Colore parte finale leva

DESCRIPTION - DESCRIZIONE	CODE - CODICE
Laser engraving (single lever) - Incisione laser (leva singola)	KLS1
Laser engraving (levers kit) - Incisione laser (kit leve)	KLS2
Aluminium stand for levers - Espositore leve in Alluminio	EX02

DESCRIPTION - DESCRIZIONE	COLOUR- COLORE	CODE - CODICE
Aluminium half lever "Straight" (RH/LH) Leva in alluminio "Dritta"(DX/SX)	black - nero	LL03_BK

DESCRIPTION - DESCRIZIONE	COLOUR- COLORE	CODE - CODICE
Aluminium half lever "Racing"(RH/LH) Leva in alluminio "Racing"(DX/SX)	black - nero	LL04_BK

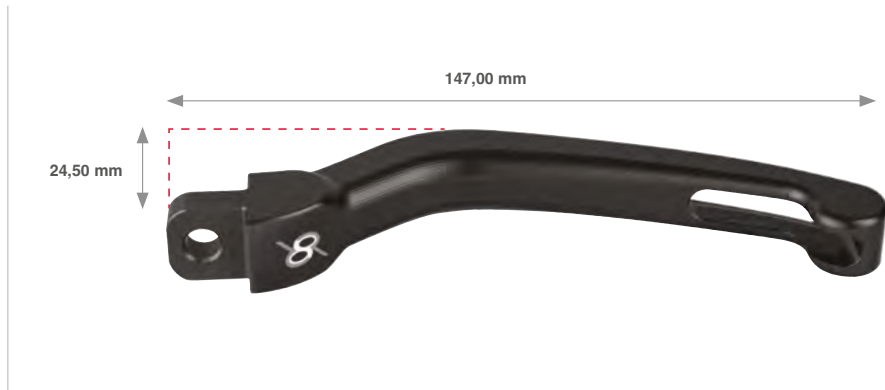

Aluminium half lever "Standard" (RH/LH) - Leva in alluminio "Standard"(DX/SX) - cod. LL05



Blue aluminium half lever "Standard" - code LL05_BL



Aluminium half lever "Straight"(RH/LH) - Leva in alluminio "Dritta" (DX/SX) - cod. LL03



Red aluminium half lever "Straight" - code LL03_BK



Aluminium half lever "Racing" (RH/LH) Leva in alluminio "Racing" (DX/SX) - cod. LL04



Black aluminium half lever "Racing" - code LL04_BK

LEVER PROTECTIONS - PROTEZIONE LEVE

NEW



EVO LEVER PROTECTIONS - PROTEZIONE LEVE EVO

DESCRIPTION - DESCRIZIONE	COLOUR - COLORE	CODE - CODICE
Right side (without adaptor) - Lato destro (senza adattatore)	black - nero	LPRL2_BK
Right side (without adaptor) - Lato destro (senza adattatore)	blue - blu	LPRL2_BL
Right side (without adaptor) - Lato destro (senza adattatore)	bronze - bronzo	LPRL2_BR
Right side (without adaptor) - Lato destro (senza adattatore)	gold - oro	LPRL2_GO
Right side (without adaptor) - Lato destro (senza adattatore)	green - verde	LPRL2_GR
Right side (without adaptor) - Lato destro (senza adattatore)	orange - arancio	LPRL2_OR
Right side (without adaptor) - Lato destro (senza adattatore)	red - rosso	LPRL2_RE
Right side (without adaptor) - Lato destro (senza adattatore)	silver - argento	LPRL2_SI

DESCRIPTION - DESCRIZIONE	COLOUR - COLORE	CODE - CODICE
Left side (without adaptor) - Lato sinistro (senza adattatore)	black - nero	LPRL2_BK
Left side (without adaptor) - Lato sinistro (senza adattatore)	blue - blu	LPRL2_BL
Left side (without adaptor) - Lato sinistro (senza adattatore)	bronze - bronzo	LPRL2_BR
Left side (without adaptor) - Lato sinistro (senza adattatore)	gold - oro	LPRL2_GO
Left side (without adaptor) - Lato sinistro (senza adattatore)	green - verde	LPRL2_GR
Left side (without adaptor) - Lato sinistro (senza adattatore)	orange - arancio	LPRL2_OR
Left side (without adaptor) - Lato sinistro (senza adattatore)	red - rosso	LPRL2_RE
Left side (without adaptor) - Lato sinistro (senza adattatore)	silver - argento	LPRL2_SI

EVO LEVER PROTECTION

In 2013 Bonamici Racing launched on the market its first ever lever-guard completely made of billet aluminum, a product destined to set standards and which over the years will have numerous imitation attempts. After 10 years Bonamici Racing expresses a new concept of lever-guard, through a natural evolution of the product it improves and perfects it from all points of view. The reduced weight and high structural rigidity mark a new record for the product category. These results were obtained thanks to careful design, the use of special aluminum alloys for aeronautical use with certified quality, together with solid machining with latest generation CNC machinery. A careful ergonomic study makes the product safe during use, the particular profile of the lever guard minimizes the risk incurred during a possible fall, allowing easy release of the hand from the handlebar. Various types of adapters with titanium screws are available for fixing, designed so that the distance from the lever can be adjusted with a range of +10mm -10mm. The entire surface is treated with galvanic anodization protection available in various colors. All this gives life to a lever guard with curvy and eye-catching shapes, with minimal aerodynamic drag obtained through the use of fluid dynamics simulation software.

A design product in full respect of the true "Made in Italy" tradition.

PROTEZIONE LEVE EVO

Nel 2013 Bonamici Racing lancia sul mercato il primo paraleva in assoluto completamente in alluminio ricavato dal pieno, un prodotto destinato a far scuola e che negli anni avrà numerosi tentativi di imitazione. Dopo 10 anni Bonamici Racing esprime un nuovo concetto di paraleva, attraverso una naturale evoluzione del prodotto lo migliora e lo perfeziona sotto tutti i punti di vista. Il peso ridotto e l'elevata rigidità strutturale segnano un nuovo record per la categoria di prodotto. Questi risultati sono stati ottenuti grazie ad un'accurata progettazione, all'impiego di speciali leghe di alluminio d'uso aeronautico con qualità certificata, unitamente alla lavorazione dal pieno con macchinari CNC d'ultima generazione. Un attento studio d'ergonomia rende il prodotto sicuro durante l'utilizzo, il particolare profilo del paraleva riduce al minimo il rischio che si corre durante un'eventuale caduta, permettendo un agevole svincolo della mano dal manubrio. Per il fissaggio sono disponibili vari tipi di adattatori con viti in titanio, progettati in modo da poter regolare la distanza dalla leva con un range di +10mm -10mm. Tutta la superficie è trattata con protezione galvanica di anodizzazione disponibile in vari colori. Tutto questo dà vita ad un paraleva dalle forme sinuose ed accattivanti, dal minimo attrito aerodinamico ottenuto mediante l'uso di software di simulazione della fluidodinamica.

Un prodotto di design nel pieno rispetto della tradizione del vero "Made in Italy".

LEVER PROTECTIONS - PROTEZIONE LEVE

EVO LEVER PROTECTIONS - PROTEZIONE LEVE EVO

ADAPTORS - ADATTATORI

DESCRIPTION - DESCRIZIONE

CODE - CODICE

for Bonamici Racing bars tube - per tubi manubrio Bonamici Racing	ADLT_U
from ø13mm to ø 14mm tube - per tubo da ø13mm a ø14mm	ADL13_U
from ø14mm to ø 15mm tube - per tubo da ø14mm a ø15mm	ADL14_U
from ø15mm to ø 16mm tube - per tubo da ø15mm a ø16mm	ADL15_U
from ø16mm to ø 17mm tube - per tubo da ø16mm a ø17mm	ADL16_U
from ø17mm to ø 18mm tube - per tubo da ø17mm a ø18mm	ADL17_U
from ø18mm to ø 19mm tube - per tubo da ø18mm a ø19mm	ADL18_U
from ø19mm to ø 20mm tube - per tubo da ø19mm a ø20mm	ADL19_U
from ø20mm to ø 21mm tube - per tubo da ø20mm a ø21mm	ADL20_U
Aprilia RS 660	ADL660_U
Aprilia RSV4/RSV4 Factory (2009/>)	ADLA_U
BMW S 1000 RR (2008-2018)	ADLB_U
BMW S 1000 RR (2019->)	ADLRR_U
Ducati Panigale V4	ADL17_U
Ducati Panigale V2	ADLT_U
Ducati Streetfighter V2	ADLSV2_U
Honda CBR1000RR-R Fireblade (2020/>)	ADLH19_U
Honda CBR 1000 RR (2008/2016)	ADLH19_U
Honda CBR 600 RR	ADLH19_U
Kawasaki ZX-10R (2011/>)	ADLZX_U
Kawasaki Ninja 400	ADLRR_U
Kawasaki ZX-4R/RR (2023/>)	ADL4R_U
Kawasaki Z 900	ADL4R_U
KTM 1290 Super Duke R (2020/2023) - KTM 1390 Super Duke R (2024/>)	ADL13_U
MV Agusta F3 675/800	ADL18_U
MV Agusta F4	ADL16_U
MV Agusta Brutale 675/800	ADL14_U
Suzuki GSX-R 1000 (2017/>)	ADLRR_U
Suzuki GSX-8S/8R (2023/>)	ADLS_U
Triumph Speed Triple 1200 RS	ADL660_U
Triumph Speed Triple 1200 RR	ADLST_U
Triumph Street Triple 765 R/RS/RS Moto2 (2023/>)	ADL765_U
Yamaha YZF R1 (1998/>)	ADLY_U
Yamaha YZF R3 (2015/>)	ADLY_U
Yamaha YZF R6 (2006/>)	ADLY_U
Yamaha YZF R7 (2021/>)	ADLY_U
Yamaha MT-09 (2021/>)	ADLY_U



LEVER PROTECTIONS - PROTEZIONE LEVE

CARBON LEVER PROTECTION

Made of fine carbon fiber, 100% made in Italy, extremely detailed both internal and external surfaces, it guarantees maximum strength and low weight.

This new particular design has been studied in detail through aerodynamics and fluid dynamics studies to reduce the air pressure both on the lever guard itself and on the brake command at high speeds.

The new design of the lever guard has been created to favor a wide movement of the hand and wrist in the various riding phases and also to facilitate the rapid release of the hand in the event of a fall or accident. In addition to being a fundamental element for safety, the Bonamici Racing carbon shift guard is a real design object that gives the bike a very beautiful and sporty look.

The peculiarity of the new carbon lever guard is that it is supplied with a titanium screw and it is possible to adjust its position both in the longitudinal axis and in the transversal axis thanks to a new bushing system mounted between the handlebar and the lever guard itself. One of a kind, perfect for Bonamici Racing handlebars. For other uses, we recommend consulting the adapter list and requesting the most suitable one for your motorcycle model.



PROTEZIONE LEVA IN CARBONIO

Realizzata in pregiata fibra di carbonio, 100% made in Italy, estremamente dettagliata in entrambe le superfici interna ed esterna, garantisce massima robustezza e peso contenuto. Questo nuovo particolare design è stato studiato nei minimi dettagli attraverso studi di aerodinamica e fluidodinamica per ridurre la pressione dell'aria sia sul paraleva stesso che sul comando del freno alle alte velocità.

Il nuovo design del paraleva è stato realizzato per favorire un ampio movimento della mano e del polso nelle varie fasi di guida e anche per facilitare il rapido rilascio della mano in caso di caduta o incidente. Oltre ad essere un elemento fondamentale per la sicurezza, il paraleva in carbonio Bonamici Racing è un vero e proprio oggetto di design che dona alla moto un aspetto molto bello e sportivo.

La particolarità del nuovo paraleva in carbonio è che viene fornito con vite in titanio ed è possibile aggiustarne la posizione sia in asse longitudinale sia in asse trasversale grazie ad un nuovo sistema a boccola montato tra il manubrio ed il paraleva stesso. Unico nel suo genere, perfetto per semimanubri Bonamici Racing, per altri usi consigliamo di consultare l'elenco adattatori e richiedere quello più adatto al vostro modello di moto.

CARBON LEVER PROTECTIONS - PROTEZIONE LEVE IN CARBONIO

DESCRIPTION - DESCRIZIONE

CODE - CODICE

Right side (without adaptor) - Lato destro (senza adattatore)	LPLITE1_R
---	-----------

ADAPTORS - ADATTATORI

DESCRIPTION - DESCRIZIONE

CODE - CODICE

for Bonamici Racing bars tube - per tubi manubrio Bonamici Racing	ADLT_U
from ø13mm to ø 14mm tube - per tubo da ø13mm a ø14mm	ADL13_U
from ø14mm to ø 15mm tube - per tubo da ø14mm a ø15mm	ADL14_U
from ø15mm to ø 16mm tube - per tubo da ø15mm a ø16mm	ADL15_U
from ø16mm to ø 17mm tube - per tubo da ø16mm a ø17mm	ADL16_U
from ø17mm to ø 18mm tube - per tubo da ø17mm a ø18mm	ADL17_U
from ø18mm to ø 19mm tube - per tubo da ø18mm a ø19mm	ADL18_U
from ø19mm to ø 20mm tube - per tubo da ø19mm a ø20mm	ADL19_U
from ø20mm to ø 21mm tube - per tubo da ø20mm a ø21mm	ADL20_U
Aprilia RS 660	ADL660_U
Aprilia RSV4/RSV4 Factory (2009/>)	ADLA_U
BMW S 1000 RR (2008-2018)	ADLB_U
BMW S 1000 RR (2019->)	ADLRR_U
Ducati Panigale V4	ADL17_U
Ducati Panigale V2	ADLT_U
Ducati Streetfighter V2	ADLSV2_U
Honda CBR1000RR-R Fireblade (2020/>)	ADLH19_U
Honda CBR 1000 RR (2008/2016)	ADLH19_U
Honda CBR 600 RR	ADLH19_U
Kawasaki ZX-10R (2011/>)	ADLZX_U
Kawasaki Ninja 400	ADLRR_U
Kawasaki ZX-4R/RR (2023/>)	ADL4R_U
Kawasaki Z 900	ADL4R_U
KTM 1290 Super Duke R (2020/2023) - KTM 1390 Super Duke R (2024/>)	ADL13_U
MV Agusta F3 675/800	ADL18_U
MV Agusta F4	ADL16_U
MV Agusta Brutale 675/800	ADL14_U
Suzuki GSX-R 1000 (2017/>)	ADLRR_U
Suzuki GSX-8S/8R (2023/>)	ADLS_U
Triumph Speed Triple 1200 RS	ADL660_U
Triumph Speed Triple 1200 RR	ADLST_U
Triumph Street Triple 765 R/RS/RS Moto2 (2023/>)	ADL765_U
Yamaha YZF R1 (1998/>)	ADLY_U
Yamaha YZF R3 (2015/>)	ADLY_U
Yamaha YZF R6 (2006/>)	ADLY_U
Yamaha YZF R7 (2021/>)	ADLY_U
Yamaha MT-09 (2021/>)	ADLY_U



LEVER PROTECTIONS - PROTEZIONE LEVE



black
nero



blue
blu



bronze
bronzo



gold
oro



green
verde



orange
arancio



red
rosso



silver
argento

ALUMINUM LEVER PROTECTIONS - PROTEZIONE LEVE IN ALLUMINIO

DESCRIPTION - DESCRIZIONE	COLOUR - COLORE	CODE - CODICE
Right side (without adaptor) - Lato destro (senza adattatore)	black - nero	LPRR_B_BK
Right side (without adaptor) - Lato destro (senza adattatore)	blue - blu	LPRR_B_BL
Right side (without adaptor) - Lato destro (senza adattatore)	bronze - bronzo	LPRR_B_BR
Right side (without adaptor) - Lato destro (senza adattatore)	gold - oro	LPRR_B_GO
Right side (without adaptor) - Lato destro (senza adattatore)	green - verde	LPRR_B_GR
Right side (without adaptor) - Lato destro (senza adattatore)	orange - arancio	LPRR_B_OR
Right side (without adaptor) - Lato destro (senza adattatore)	red - rosso	LPRR_B_RE
Right side (without adaptor) - Lato destro (senza adattatore)	silver - argento	LPRR_B_SI

Left side (without adaptor) - Lato sinistro (senza adattatore)	black - nero	LPRL_B_BK
Left side (without adaptor) - Lato sinistro (senza adattatore)	blue - blu	LPRL_B_BL
Left side (without adaptor) - Lato sinistro (senza adattatore)	bronze - bronzo	LPRL_B_BR
Left side (without adaptor) - Lato sinistro (senza adattatore)	gold - oro	LPRL_B_GO
Left side (without adaptor) - Lato sinistro (senza adattatore)	green - verde	LPRL_B_GR
Left side (without adaptor) - Lato sinistro (senza adattatore)	orange - arancio	LPRL_B_OR
Left side (without adaptor) - Lato sinistro (senza adattatore)	red - rosso	LPRL_B_RE
Left side (without adaptor) - Lato sinistro (senza adattatore)	silver - argento	LPRL_B_SI



LEVER PROTECTIONS - PROTEZIONE LEVE

ADAPTORS - ADATTATORI

DESCRIPTION - DESCRIZIONE	CODE - CODICE
for Bonamici Racing bars tube - per tubi manubrio Bonamici Racing	ADLT
from ø13mm to ø 14mm tube - per tubo da ø13mm a ø14mm	ADL13
from ø14mm to ø 15mm tube - per tubo da ø14mm a ø15mm	ADL14
from ø15mm to ø 16mm tube - per tubo da ø15mm a ø16mm	ADL15
from ø16mm to ø 17mm tube - per tubo da ø16mm a ø17mm	ADL16
from ø17mm to ø 18mm tube - per tubo da ø17mm a ø18mm	ADL17
from ø18mm to ø 19mm tube - per tubo da ø18mm a ø19mm	ADL18
from ø19mm to ø 20mm tube - per tubo da ø19mm a ø20mm	ADL19
from ø20mm to ø 21mm tube - per tubo da ø20mm a ø21mm	ADL20
Aprilia RS 660	ADL660
Aprilia RSV4/RSV4 Factory (2009/>)	ADLA
BMW S 1000 RR (2008-2018)	ADLB
BMW S 1000 RR (2019->)	ADLRR
Ducati Panigale V4	ADL17
Ducati Panigale V2	ADLT
Ducati Streetfighter V2	ADLSV2
Honda CBR1000RR-R Fireblade (2020/>)	ADLH19
Honda CBR 1000 RR (2008/2016)	ADLH19
Honda CBR 600 RR	ADLH19
Kawasaki ZX-10R (2011/>)	ADLZX
Kawasaki Ninja 400	ADLRR
Kawasaki ZX-4R/RR (2023->)	ADL4R
Kawasaki Z 900	ADL4R
KTM 1290 Super Duke R (2020/2023) - KTM 1390 Super Duke R (2024/>)	ADL13
MV Agusta F3 675/800	ADL18
MV Agusta F4	ADL16
MV Agusta Brutale 675/800	ADL14
Suzuki GSX-R 1000 (2017/>)	ADLRR
Suzuki GSX-8S/8R (2023/>)	ADLS
Triumph Speed Triple 1200 RS	ADL660
Triumph Speed Triple 1200 RR	ADLST
Triumph Street Triple 765 R/RS/RS Moto2 (2023/>)	ADL765
Yamaha YZF R1 (1998/>)	ADLY
Yamaha YZF R3 (2015/>)	ADLY
Yamaha YZF R6 (2006/>)	ADLY
Yamaha YZF R7 (2021/>)	ADLY
Yamaha MT-09 (2021/>)	ADLY

ACCESSORIES - ACCESSORI

DESCRIPTION - DESCRIZIONE	CODE - CODICE
Laser engraving - Incisione laser	LLS

FRONT PEG SPARE PART - PUNTALINO DI RICAMBIO

DESCRIPTION - DESCRIZIONE	COLOUR - COLORE	CODE - CODICE
Front peg spare part (right side) - Puntalino di ricambio (lato destro)	black - nero	LPP_DX_BK
Front peg spare part (right side) - Puntalino di ricambio (lato destro)	blue - blu	LPP_DX_BL
Front peg spare part (right side) - Puntalino di ricambio (lato destro)	gold - oro	LPP_DX_GO
Front peg spare part (right side) - Puntalino di ricambio (lato destro)	green - verde	LPP_DX_GR
Front peg spare part (right side) - Puntalino di ricambio (lato destro)	orange - arancio	LPP_DX_OR
Front peg spare part (right side) - Puntalino di ricambio (lato destro)	red - rosso	LPP_DX_RE
Front peg spare part (right side) - Puntalino di ricambio (lato destro)	silver - argento	LPP_DX_SI
Front peg spare part (right side) - Puntalino di ricambio (lato destro)	bronze - bronzo	LPP_DX_BR
Front peg spare part (left side) - Puntalino di ricambio (lato sinistro)	black - nero	LPP_SX_BK
Front peg spare part (left side) - Puntalino di ricambio (lato sinistro)	blue - blu	LPP_SX_BL
Front peg spare part (left side) - Puntalino di ricambio (lato sinistro)	gold - oro	LPP_SX_GO
Front peg spare part (left side) - Puntalino di ricambio (lato sinistro)	green - verde	LPP_SX_GR
Front peg spare part (left side) - Puntalino di ricambio (lato sinistro)	orange - arancio	LPP_SX_OR
Front peg spare part (left side) - Puntalino di ricambio (lato sinistro)	red - rosso	LPP_SX_RE
Front peg spare part (left side) - Puntalino di ricambio (lato sinistro)	silver - argento	LPP_SX_SI
Front peg spare part (left side) - Puntalino di ricambio (lato sinistro)	bronze - bronzo	LPP_SX_BR



HANDLEBARS - SEMIMANUBRI

Tube for unlifted handlebars

Tubo per semimanubrio non rialzato

Tube length - Lunghezza tubo	245 mm
Tube useful length - Lunghezza utilizzabile tubo	225 mm
Outer tube diameter - Diametro esterno tubo	22 mm
Inner tube diameter - Diametro interno tubo	16 mm

Tube for lifted handlebars

Tubo per semimanubrio rialzato

Tube length - Lunghezza tubo	270 mm
Tube useful length - Lunghezza utilizzabile tubo	235 mm
Outer tube diameter - Diametro esterno tubo	22 mm
Inner tube diameter - Diametro interno tubo	16 mm

UNLIFTED HANDLEBARS
SEMIMANUBRI NON RIALZATI



LIFTED HANDLEBARS
SEMIMANUBRI RIALZATI



WARNING - ATTENZIONE

At the time of purchase it is necessary to choose the ideal diameter, first make sure of the diameter of the front forks of the bike and then choose the right diameter of the handlebars.

Al momento dell'acquisto occorre scegliere il diametro ideale, per prima cosa assicurarsi del diametro forcelle anteriori della moto e successivamente scegliere il giusto diametro dei semimanubri.

Bonamici Racing realizes for the major sports bikes, handlebars that allow a sporty driving at the highest levels and a perfect feeling in all conditions.

Two version: raised and not raised, both with inclination of 6.5° degrees. Each element of the Bonamici Racing handlebars is made from solid billet aluminium machined with cnc technology.

Bonamici Racing realizza per le maggiori moto sportive semimanubri che consentono una guida sportiva ai massimi livelli e un feeling perfetto in ogni condizione.

Varie versioni, rialzati e non rialzati, entrambi con inclinazione di 6,5° gradi. Ogni elemento del semimanubrio Bonamici Racing è realizzato dal pieno in alluminio billet lavorato con tecnologia cnc



BMW S 1000 RR (2023)
lifted handlebars / Diameter 55 mm - cod. SM55S1KW

HANDLEBARS - SEMIMANUBRI

DESCRIPTION DESCRIZIONE	OFFSET	HEIGHT RIALZO	SPARE TUBE TUBO DI RICAMBIO	CODE CODICE
Diameter 41 mm lifted - Diametro 41 mm rialzati	45 mm	15,5 mm	RASM_1	SM41
Diameter 41 mm lifted 28mm - Diametro 41 mm rialzato 28 mm	45 mm	28 mm	RASM_1	SM41_30
Diameter 45 mm lifted - Diametro 45 mm rialzati (Kawasaki ZX-4R/RR 2023->)	28 mm	30 mm	RASM_2	SM45A
Diameter 47 mm lifted - Diametro 47 mm rialzati	49 mm	15,5 mm	RASM_1	SM47
Diameter 48 mm lifted - Diametro 48 mm rialzati	49 mm	15,5 mm	RASM_1	SM48
Diameter 50 mm lifted - Diametro 50 mm rialzati	49 mm	15,5 mm	RASM_1	SM50
Diameter 50 mm lifted - Diametro 50 mm rialzati	18 mm	26 mm	RASM_2	SM50A
NEW Diameter 50 mm lifted - Diametro 50 mm rialzati (Suzuki GSX-8R 2023->) they include steering stop code BS04 and steering plate caps code TPS01 comprendono battuta di sterzo codice BS04 e tappi piastra di sterzo codice TPS01	18 mm	26 mm	RASM_2	SM50A8R
Diameter 50 mm unlifted - Diametro 50 mm non rialzati	16 mm	0 mm	RASM_2	SM50B
Diameter 51 mm lifted - Diametro 51 mm rialzati	49 mm	15,5 mm	RASM_1	SM51
Diameter 51 mm lifted - Diametro 51 mm rialzati (Aprilia RS 660) ⁴ (Aprilia RSV4 2021)	18 mm	26 mm	RASM_2	SM51A
Diameter 51 mm unlifted - Diametro 51 mm non rialzati	16 mm	0 mm	RASM_2	SM51B
Diameter 52 mm lifted - Diametro 52 mm rialzati	51,5 mm	15,5 mm	RASM_1	SM52
Diameter 52 mm unlifted - Diametro 52 mm non rialzati	16 mm	0 mm	RASM_2	SM52B
Diameter 53 mm lifted - Diametro 53 mm rialzati	51,5 mm	15,5 mm	RASM_1	SM53
Diameter 53 mm unlifted - Diametro 53 mm non rialzati	16 mm	0 mm	RASM_2	SM53B
Diameter 53 mm unlifted - Diametro 53 mm non rialzati (Ducati Panigale V4/V4S) ¹	16 mm	0 mm	RASM_2	SM53PA
Diameter 53 mm unlifted - Diametro 53 mm non rialzati (Panigale V2 2020-2024) ¹	40 mm	0 mm	RASM_2	SM53PV2
Diameter 53 mm unlifted - Diametro 53 mm non rialzati (Ducati Panigale V4/V4S 2018-2024) ¹	40 mm	0 mm	RASM_2	SM53PV4
Diameter 53 mm unlifted - Diametro 53 mm non rialzati (Ducati Panigale V4R 2018-2024) ¹	40 mm	0 mm	RASM_2	SM53PV4R
Diameter 55 mm lifted - Diametro 55 mm rialzati	51,5 mm	15,5 mm	RASM_1	SM55
Diameter 55 mm unlifted - Diametro 55 mm non rialzati	18 mm	0 mm	RASM_2	SM55B
Diameter 55 mm lifted - Diametro 55 mm rialzati ² (BMW S 1000 RR / M 1000 RR '19/>)	18 mm	27 mm	RASM_2	SM55S1K
Diameter 55 mm lifted - Diametro 55 mm rialzati ³ (BMW S 1000 RR / M 1000 RR '19/>)	18 mm	27 mm	RASM_2	SM55S1KW
Diameter 55 mm unlifted - Diametro 55 mm non rialzati ² (BMW S 1000 RR / M 1000 RR '19/>)	18 mm	0 mm	RASM_2	SM55BS1K
Steering stops - Coppia battute di sterzo				BS02



Diameter 53 mm unlifted
Diametro 53 mm (Ducati Panigale V4/V4S)- cod. SM53PV4



Diameter 55 mm lifted
Diametro 55 mm (BMW S 1000 RR '19/>) - cod. SM55S1K

HANDLEBARS SPARE PARTS - RICAMBI SEMIMANUBRI

DESCRIPTION - DESCRIZIONE	CODE - CODICE
Clamps for OEM steering plate (BMW S 1000 RR - M 1000 RR '19 />) Coppia di supporti ad arco per piastra di sterzo originale (BMW S 1000 RR - M 1000 RR '19 />)	BMRS1K
Pair of balancers for SM55S1K/SM55B - Coppia contrappesi per SM55S1K/SM55B	ADLS1K_2
Spare bracket right side - Bracciale di ricambio lato DX	BMRD
Spare bracket left side - Bracciale di ricambio lato SX	BMRS
Spare tube for lifted handlebars (Tube length 270 mm - Tube useful length 235 mm) Tubo di ricambio per semimanubri rialzati (Lunghezza tubo 270 mm - Lunghezza utilizzabile 235mm)	RASM_1
Spare tube for unlifted handlebars (Tube length 245 mm - Tube useful length 225 mm) Tubo ricambio per semimanubri non rialzati (Lunghezza tubo 245 mm - Lunghezza utilizzabile 225mm)	RASM_2
Tube cap (end cap) - Tappo tubo (tappo finale)	TASM_2
Bracket for steering damper - Bracciale ammortizzatore di sterzo	BAMS
Steering stop for Suzuki GSX-8R - Battuta di sterzo per Suzuki GSX-8R	BS04
Steering plate caps for Suzuki GSX-8R - Tappi piastra di sterzo per Suzuki GSX-8R	TPS01

WARNING - ATTENZIONE

- 1 • Include the bracket for steering damper
• Include il bracciale per l'ammortizzatore di sterzo
- 2 • Handlebars to use the OEM triple clamp (include the clamps for steering plate) - Spare tube code RASM_2
• Semimanubri utilizzabili con la piastra di sterzo originale (Include la coppia di supporti ad arco per la piastra di sterzo)
Tubo di ricambio cod. RASM_2
- 3 • Handlebars to use with Bonamic Racing top triple clamp (not include the clamps for steering plate) - Spare tube code RASM_2
• Semimanubri utilizzabili con la piastra di sterzo Bonamic Racing (non include la coppia di supporti ad arco per la piastra di sterzo)
Tubo di ricambio cod. RASM_2
- 4 • We recommend purchasing the steering stops code - BS02
• Consigliamo l'acquisto delle battute di sterzo codice - BS02

MEASUREMENT SCHEME - SCHEMA MISURE

- Height means the distance between bracelet center / tube axis
- Offset means the distance between fork axis / tube axis
- Per Rialzo si intende la distanza tra centro bracciale / asse tubo
- Per Offset si intende la distanza tra asse forcella / asse tubo

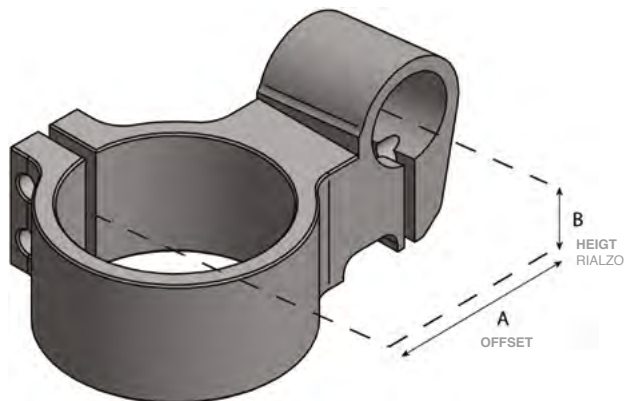

OFFSET

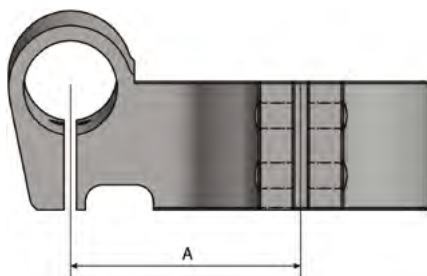

HEIGHT - RIALZO

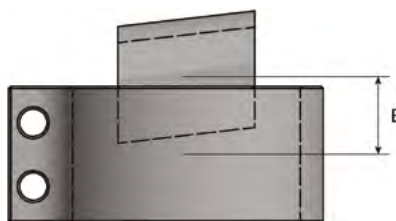

CHAIN ADJUSTER - TENDICATENA



black
nero



blue
blu



gold
oro



red
rosso



silver
argento



Made of Ergal machined from solid with CNC technology, the Bonamici Racing chain adjuster is robust and effective, with the use of bearings to completely eliminate friction and for the first time with adjustable micrometric system. It is possible to customize the inner part in various colors, while the outer part is only available in black color

Realizzato in Ergal ricavato dal pieno con tecnologia CNC, il tendicatena Bonamici Racing è robusto ed efficace, con l'uso di cuscinetti per eliminare completamente l'attrito e le posizioni regolabili micrometricamente. È possibile la personalizzazione in vari colori per la parte interna, mentre la parte esterna è disponibile solo di colore nero

CHAIN ADJUSTER - TENDICATENA

BRAND	MODEL - MODELLO	FROM - DAL	TO - AL	COLOUR-COLORE	CODE - CODICE		BRAND	MODEL - MODELLO	FROM - DAL	TO - AL	COLOUR-COLORE	CODE - CODICE
Aprilia	RS 660/Tuono 660	2020	>	black - nero	CHAD12_BK	NEW	Honda	CBR 600 RR	2024	>	black - nero	CHAD14_BK
Aprilia	RS 660/Tuono 660	2020	>	blue - blu	CHAD12_BL	NEW	Honda	CBR 600 RR	2024	>	blue - blu	CHAD14_BL
Aprilia	RS 660/Tuono 660	2020	>	gold - oro	CHAD12_GO	NEW	Honda	CBR 600 RR	2024	>	gold - oro	CHAD14_GO
Aprilia	RS 660/Tuono 660	2020	>	red - rosso	CHAD12_RE	NEW	Honda	CBR 600 RR	2024	>	red - rosso	CHAD14_RE
Aprilia	RS 660/Tuono 660	2020	>	silver - argento	CHAD12_SI	NEW	Honda	CBR 600 RR	2024	>	silver - argento	CHAD14_SI
Aprilia	RSV4/Tuono V4	2015	2020	black - nero	CHAD04_BK		Honda	CBR1000RR-R Fireblade	2020	>	black - nero	CHAD10_BK
Aprilia	RSV4/Tuono V4	2015	2020	blue - blu	CHAD04_BL		Honda	CBR1000RR-R Fireblade	2020	>	blue - blu	CHAD10_BL
Aprilia	RSV4/Tuono V4	2015	2020	gold - oro	CHAD04_GO		Honda	CBR1000RR-R Fireblade	2020	>	gold - oro	CHAD10_GO
Aprilia	RSV4/Tuono V4	2015	2020	red - rosso	CHAD04_RE		Honda	CBR1000RR-R Fireblade	2020	>	red - rosso	CHAD10_RE
Aprilia	RSV4/Tuono V4	2015	2020	silver - argento	CHAD04_SI		Honda	CBR1000RR-R Fireblade	2020	>	silver - argento	CHAD10_SI
Aprilia	RSV4/RSV4 Factory/Tuono V4	2021	>	black - nero	CHAD13_BK		Kawasaki	ZX-10R	2016	>	black - nero	CHAD02_BK
Aprilia	RSV4/RSV4 Factory/Tuono V4	2021	>	blue - blu	CHAD13_BL		Kawasaki	ZX-10R	2016	>	blue - blu	CHAD02_BL
Aprilia	RSV4/RSV4 Factory/Tuono V4	2021	>	gold - oro	CHAD13_GO		Kawasaki	ZX-10R	2016	>	gold - oro	CHAD02_GO
Aprilia	RSV4/RSV4 Factory/Tuono V4	2021	>	red - rosso	CHAD13_RE		Kawasaki	ZX-10R	2016	>	red - rosso	CHAD02_RE
Aprilia	RSV4/RSV4 Factory/Tuono V4	2021	>	silver - argento	CHAD13_SI		Kawasaki	ZX-10R	2016	>	silver - argento	CHAD02_SI
BMW	S 1000 RR	2008	2018	black - nero	CHAD01_BK		Suzuki	GSX-R 1000	2017	>	black - nero	CHAD06_BK
BMW	S 1000 RR	2008	2018	blue - blu	CHAD01_BL		Suzuki	GSX-R 1000	2017	>	blue - blu	CHAD06_BL
BMW	S 1000 RR	2008	2018	gold - oro	CHAD01_GO		Suzuki	GSX-R 1000	2017	>	gold - oro	CHAD06_GO
BMW	S 1000 RR	2008	2018	red - rosso	CHAD01_RE		Suzuki	GSX-R 1000	2017	>	red - rosso	CHAD06_RE
BMW	S 1000 RR	2008	2018	silver - argento	CHAD01_SI		Suzuki	GSX-R 1000	2017	>	silver - argento	CHAD06_SI
BMW	S 1000 RR	2019	>	black - nero	CHAD09_BK		Suzuki	GSX-S 1000	2021	>	black - nero	CHAD06_BK
BMW	S 1000 RR	2019	>	blue - blu	CHAD09_BL		Suzuki	GSX-S 1000	2021	>	blue - blu	CHAD06_BL
BMW	S 1000 RR	2019	>	gold - oro	CHAD09_GO		Suzuki	GSX-S 1000	2021	>	gold - oro	CHAD06_GO
BMW	S 1000 RR	2019	>	red - rosso	CHAD09_RE		Suzuki	GSX-S 1000	2021	>	red - rosso	CHAD06_RE
BMW	S 1000 RR	2019	>	silver - argento	CHAD09_SI		Suzuki	GSX-S 1000	2021	>	silver - argento	CHAD06_SI
BMW	S 1000 R	2012	2020	black - nero	CHAD01_BK		Yamaha	YZF R6	2017	>	black - nero	CHAD07_BK
BMW	S 1000 R	2012	2020	blue - blu	CHAD01_BL		Yamaha	YZF R6	2017	>	blue - blu	CHAD07_BL
BMW	S 1000 R	2012	2020	gold - oro	CHAD01_GO		Yamaha	YZF R6	2017	>	gold - oro	CHAD07_GO
BMW	S 1000 R	2012	2020	red - rosso	CHAD01_RE		Yamaha	YZF R6	2017	>	red - rosso	CHAD07_RE
BMW	S 1000 R	2012	2020	silver - argento	CHAD01_SI		Yamaha	YZF R6	2017	>	silver - argento	CHAD07_SI
BMW	S 1000 R - M 1000 R	2021	>	black - nero	CHAD09_BK		Yamaha	YZF R1/MT-10	2015	2019	black - nero	CHAD03_BK
BMW	S 1000 R - M 1000 R	2021	>	blue - blu	CHAD09_BL		Yamaha	YZF R1/MT-10	2015	2019	blue - blu	CHAD03_BL
BMW	S 1000 R - M 1000 R	2021	>	gold - oro	CHAD09_GO		Yamaha	YZF R1/MT-10	2015	2019	gold - oro	CHAD03_GO
BMW	S 1000 R - M 1000 R	2021	>	red - rosso	CHAD09_RE		Yamaha	YZF R1/MT-10	2015	2019	red - rosso	CHAD03_RE
BMW	S 1000 R - M 1000 R	2021	>	silver - argento	CHAD09_SI		Yamaha	YZF R1/MT-10	2015	2019	silver - argento	CHAD03_SI
Honda	CBR 1000 RR	2008	2016	black - nero	CHAD14_BK		Yamaha	YZF R1	2020	>	black - nero	CHAD11_BK
Honda	CBR 1000 RR	2008	2016	blue - blu	CHAD14_BL		Yamaha	YZF R1	2020	>	blue - blu	CHAD11_BL
Honda	CBR 1000 RR	2008	2016	gold - oro	CHAD14_GO		Yamaha	YZF R1	2020	>	gold - oro	CHAD11_GO
Honda	CBR 1000 RR	2008	2016	red - rosso	CHAD14_RE		Yamaha	YZF R1	2020	>	red - rosso	CHAD11_RE
Honda	CBR 1000 RR	2008	2016	silver - argento	CHAD14_SI		Yamaha	YZF R1	2020	>	silver - argento	CHAD11_SI

OIL TANK - SERBATOIO OLIO

NEW

DESCRIPTION - DESCRIZIONE

COLOUR- COLORE

CODE - CODICE

10 ml Rear oil tank - Serbatoio olio posteriore 10 ml	black - nero	VS10P_BK
10 ml Rear oil tank - Serbatoio olio posteriore 10 ml	blue - blu	VS10P_BL
10 ml Rear oil tank - Serbatoio olio posteriore 10 ml	bronze - bronzo	VS10P_BR
10 ml Rear oil tank - Serbatoio olio posteriore 10 ml	gold - oro	VS10P_GO
10 ml Rear oil tank - Serbatoio olio posteriore 10 ml	green - verde	VS10P_GR
10 ml Rear oil tank - Serbatoio olio posteriore 10 ml	orange - arancio	VS10P_OR
10 ml Rear oil tank - Serbatoio olio posteriore 10 ml	red - rosso	VS10P_RE
10 ml Rear oil tank - Serbatoio olio posteriore 10 ml	silver - argento	VS10P_SI

Bracket tank - Supporto serbatoio	black	VS10S3
-----------------------------------	-------	--------



A new solution for the rear oil reservoir has been expressed by Bonamici Racing, always ready to undertake projects looking for style in step with time.

A new compact and captivating shape that does not penalize its maximum capacity, bringing it to 10ml for perfect autonomy during use.

The excellent chromatic effect was achieved by combining the black anodized cover with the contrasting body in various colours.

Like all Bonamici Racing products, the rear oil reservoir also uses an aluminum alloy for aeronautical use, made of billet aluminum with latest generation CNC machinery, treated with galvanic anodization in various colours.

A standard mounting bracket is also available which allows its use on most motorcycle models.

Una nuova soluzione per la vaschetta olio posteriore è stato espresso da Bonamici Racing, sempre pronta ad intraprendere progetti alla ricerca di stili al passo col tempo.

Un nuova forma compatta ed accattivante che non ne penalizza la capacità massima portandola a 10ml per una perfetta autonomia durante l'utilizzo.

L'eccellente effetto cromatico è stato ottenuto mediante l'abbinamento del coperchio anodizzato nero con il corpo in contrasto in vari colori.

Come tutti i prodotti Bonamici Racing, anche per la vaschetta olio posteriore viene impiegata una lega di alluminio per uso aeronautico lavorata dal pieno con macchinari CNC di ultima generazione, trattata con anodizzazione galvanica in vari colori. E' inoltre disponibile una staffa standard per il fissaggio che ne permette l'impiego sulla maggior parte dei modelli di moto.



The 8ml version has been redesigned with a more modern design. All reservoirs are made with aluminum machined from solid and are available in various colors.

La versione da 8ml è stata riprogettata con un design più moderno. I serbatoi sono in alluminio ricavati dal pieno e sono disponibili in vari colori.

OIL TANK - SERBATOIO OLIO



DESCRIPTION - DESCRIZIONE

COLOUR - COLORE

CODE - CODICE

8 ml Rear oil tank - Serbatoio olio posteriore 8 ml	black - nero	0040_BK
8 ml Rear oil tank - Serbatoio olio posteriore 8 ml	blue - blu	0040_BL
8 ml Rear oil tank - Serbatoio olio posteriore 8 ml	bronze - bronzo	0040_BR
8 ml Rear oil tank - Serbatoio olio posteriore 8 ml	gold - oro	0040_GO
8 ml Rear oil tank - Serbatoio olio posteriore 8 ml	green - verde	0040_GR
8 ml Rear oil tank - Serbatoio olio posteriore 8 ml	orange - arancio	0040_OR
8 ml Rear oil tank - Serbatoio olio posteriore 8 ml	red - rosso	0040_RE
8 ml Rear oil tank - Serbatoio olio posteriore 8 ml	silver - argento	0040_SI

Bracket tank - Supporto serbatoio

black

00S4



OIL TANK - SERBATOIO OLIO

BRACKET TANK - SUPPORTO SERBATOIO

EVO SWINGARMS SPOOLS - SUPPORTI CAVALLETTO EVO

NEW



DESCRIPTION - DESCRIZIONE

COLOUR- COLORE

CODE - CODICE

standard ø 6 mm	black - nero	SCS6_BK
standard ø 6 mm	blue - blu	SCS6_BL
standard ø 6 mm	bronze - bronzo	SCS6_BR
standard ø 6 mm	gold - oro	SCS6_GO
standard ø 6 mm	green - verde	SCS6_GR
standard ø 6 mm	orange - arancio	SCS6_OR
standard ø 6 mm	red - rosso	SCS6_RE
standard ø 6 mm	silver - argento	SCS6_SI

DESCRIPTION - DESCRIZIONE

COLOUR- COLORE

CODE - CODICE

standard ø 8 mm	black - nero	SCS8_BK
standard ø 8 mm	blue - blu	SCS8_BL
standard ø 8 mm	bronze - bronzo	SCS8_BR
standard ø 8 mm	gold - oro	SCS8_GO
standard ø 8 mm	green - verde	SCS8_GR
standard ø 8 mm	orange - arancio	SCS8_OR
standard ø 8 mm	red - rosso	SCS8_RE
standard ø 8 mm	silver - argento	SCS8_SI

DESCRIPTION - DESCRIZIONE

COLOUR- COLORE

CODE - CODICE

standard (connection - attacco M10 x 1,25)	black - nero	SCS10F_BK
standard (connection - attacco M10 x 1,25)	blue - blu	SCS10F_BL
standard (connection - attacco M10 x 1,25)	bronze - bronzo	SCS10F_BR
standard (connection - attacco M10 x 1,25)	gold - oro	SCS10F_GO
standard (connection - attacco M10 x 1,25)	green - verde	SCS10F_GR
standard (connection - attacco M10 x 1,25)	orange - arancio	SCS10F_OR
standard (connection - attacco M10 x 1,25)	red - rosso	SCS10F_RE
standard (connection - attacco M10 x 1,25)	silver - argento	SCS10F_SI

DESCRIPTION - DESCRIZIONE

COLOUR- COLORE

CODE - CODICE

standard (connection - attacco M10 x 1,5)	black - nero	SCS10G_BK
standard (connection - attacco M10 x 1,5)	blue - blu	SCS10G_BL
standard (connection - attacco M10 x 1,5)	bronze - bronzo	SCS10G_BR
standard (connection - attacco M10 x 1,5)	gold - oro	SCS10G_GO
standard (connection - attacco M10 x 1,5)	green - verde	SCS10G_GR
standard (connection - attacco M10 x 1,5)	orange - arancio	SCS10G_OR
standard (connection - attacco M10 x 1,5)	red - rosso	SCS10G_RE
standard (connection - attacco M10 x 1,5)	silver - argento	SCS10G_SI

Bonamici Racing, always careful to improve its products, introduces a new system for swingarm spools, with a modern and light design which, thanks to the combination of colored and black elements, results in a product with elegant, original, functional and strong aesthetic impacts.

This system is designed with modularity such as to cover all types of connections with M6, M8, M10x1.25 and M10x1.5 threads.

Completely machined from solid aluminum using the latest generation CNC machinery, the swingarm spools are available with anodization in various colors in both the standard version and the racing version.

Bonamici Racing, da sempre attenta a migliorare i propri prodotti, introduce un nuovo sistema per i supporti cavalletto, dal design moderno e leggero che, grazie all'abbinamento fra elementi colorati con elementi neri, dà come risultato un prodotto dal forte impatto stilistico e funzionale.

Questo sistema è concepito con una modularità tale da coprire tutte le tipologie di attacchi con filettature M6, M8, M10x1.25 ed M10x1.5.

Completamente in alluminio ricavati dal pieno con macchinari CNC di ultima generazione, i supporti cavalletto sono disponibili con anodizzazioni in vari colori sia nella versione standard che nella versione racing.

DESCRIPTION - DESCRIZIONE

COLOUR- COLORE

CODE - CODICE

racing ø 6 mm	black - nero	SCR6_BK
racing ø 6 mm	blue - blu	SCR6_BL
racing ø 6 mm	bronze - bronzo	SCR6_BR
racing ø 6 mm	gold - oro	SCR6_GO
racing ø 6 mm	green - verde	SCR6_GR
racing ø 6 mm	orange - arancio	SCR6_OR
racing ø 6 mm	red - rosso	SCR6_RE
racing ø 6 mm	silver - argento	SCR6_SI

DESCRIPTION - DESCRIZIONE

COLOUR- COLORE

CODE - CODICE

racing ø 8 mm	black - nero	SCR8_BK
racing ø 8 mm	blue - blu	SCR8_BL
racing ø 8 mm	bronze - bronzo	SCR8_BR
racing ø 8 mm	gold - oro	SCR8_GO
racing ø 8 mm	green - verde	SCR8_GR
racing ø 8 mm	orange - arancio	SCR8_OR
racing ø 8 mm	red - rosso	SCR8_RE
racing ø 8 mm	silver - argento	SCR8_SI

DESCRIPTION - DESCRIZIONE

COLOUR- COLORE

CODE - CODICE

racing (connection - attacco M10 x 1,25)	black - nero	SCR10F_BK
racing (connection - attacco M10 x 1,25)	blue - blu	SCR10F_BL
racing (connection - attacco M10 x 1,25)	bronze - bronzo	SCR10F_BR
racing (connection - attacco M10 x 1,25)	gold - oro	SCR10F_GO
racing (connection - attacco M10 x 1,25)	green - verde	SCR10F_GR
racing (connection - attacco M10 x 1,25)	orange - arancio	SCR10F_OR
racing (connection - attacco M10 x 1,25)	red - rosso	SCR10F_RE
racing (connection - attacco M10 x 1,25)	silver - argento	SCR10F_SI

DESCRIPTION - DESCRIZIONE

COLOUR- COLORE

CODE - CODICE

racing (connection - attacco M10 x 1,5)	black - nero	SCR10G_BK
racing (connection - attacco M10 x 1,5)	blue - blu	SCR10G_BL
racing (connection - attacco M10 x 1,5)	bronze - bronzo	SCR10G_BR
racing (connection - attacco M10 x 1,5)	gold - oro	SCR10G_GO
racing (connection - attacco M10 x 1,5)	green - verde	SCR10G_GR
racing (connection - attacco M10 x 1,5)	orange - arancio	SCR10G_OR
racing (connection - attacco M10 x 1,5)	red - rosso	SCR10G_RE
racing (connection - attacco M10 x 1,5)	silver - argento	SCR10G_SI



SWINGARMS SPOOLS - SUPPORTI CAVALLETTO



black nero
blue blu
bronze bronzo
gold oro
green verde
orange arancio
red rosso
silver argento

DESCRIPTION - DESCRIZIONE

COLOUR- COLORE

CODE - CODICE

classic ø 6 mm	black - nero	0025_BK
classic ø 6 mm	blue - blu	0025_BL
classic ø 6 mm	bronze - bronzo	0025_BR
classic ø 6 mm	gold - oro	0025_GO
classic ø 6 mm	green - verde	0025_GR
classic ø 6 mm	orange - arancio	0025_OR
classic ø 6 mm	red - rosso	0025_RE
classic ø 6 mm	silver - argento	0025_SI
classic ø 8 mm	black - nero	0026_BK
classic ø 8 mm	blue - blu	0026_BL
classic ø 8 mm	bronze - bronzo	0026_BR
classic ø 8 mm	gold - oro	0026_GO
classic ø 8 mm	green - verde	0026_GR
classic ø 8 mm	orange - arancio	0026_OR
classic ø 8 mm	red - rosso	0026_RE
classic ø 8 mm	silver - argento	0026_SI
classic "racing" ø 6 mm	black - nero	0027_BK
classic "racing" ø 8 mm	black - nero	0028_BK



The rear stand supports, made in aluminum machined from solid, are available in the following sizes, 6mm, 8mm, are available in various colors

I supporti posteriori per i cavalletti in alluminio ricavati dal pieno sono disponibili nelle misure da 6mm, da 8mm e vari colori.



BLOCKS MIRROR - TAPPI SPECCHIO

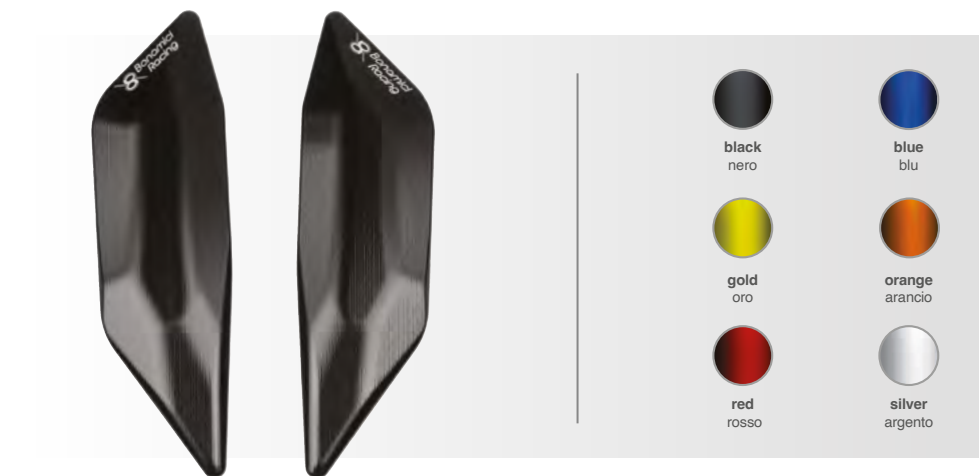

BRAND	MODEL - MODELLO	COLOUR- COLORE	CODE - CODICE
BMW	S 1000 RR (2019/ >)	black - nero	BM07_BK
BMW	S 1000 RR (2019/ >)	blue - blu	BM07_BL
BMW	S 1000 RR (2019/ >)	gold - oro	BM07_GO
BMW	S 1000 RR (2019/ >)	orange - arancio	BM07_OR
BMW	S 1000 RR (2019/ >)	red - rosso	BM07_RE
BMW	S 1000 RR (2019/ >)	silver - argento	BM07_SI
Ducati	Panigale V2 (2020-2024) / Panigale V4 (2018-2024)	black - nero	BM06_BK
Ducati	Panigale V2 (2020-2024) / Panigale V4 (2018-2024)	blue - blu	BM06_BL
Ducati	Panigale V2 (2020-2024) / Panigale V4 (2018-2024)	gold - oro	BM06_GO
Ducati	Panigale V2 (2020-2024) / Panigale V4 (2018-2024)	orange - arancio	BM06_OR
Ducati	Panigale V2 (2020-2024) / Panigale V4 (2018-2024)	red - rosso	BM06_RE
Ducati	Panigale V2 (2020-2024) / Panigale V4 (2018-2024)	silver - argento	BM06_SI
Yamaha	YZF R7 (2021->)	black - nero	BM08_BK
Yamaha	YZF R7 (2021->)	blue - blu	BM08_BL
Yamaha	YZF R7 (2021->)	gold - oro	BM08_GO
Yamaha	YZF R7 (2021->)	orange - arancio	BM08_OR
Yamaha	YZF R7 (2021->)	red - rosso	BM08_RE
Yamaha	YZF R7 (2021->)	silver - argento	BM08_SI



YAMAHA YZF R7 (2021/>)
code BM08_BK



OIL CAPS - TAPPI OLIO



BRAND	MODEL - MODELLO	THREAD - FILETTO	COLOUR- COLORE	CODE - CODICE
Aprilia	Tuareg 660	M18x1,5	black - nero	T010_BK
Aprilia	Tuareg 660	M18x1,5	blue - blu	T010_BL
Aprilia	Tuareg 660	M18x1,5	gold - oro	T010_GO
Aprilia	Tuareg 660	M18x1,5	green - verde	T010_GR
Aprilia	Tuareg 660	M18x1,5	orange - arancio	T010_OR
Aprilia	Tuareg 660	M18x1,5	red - rosso	T010_RE
Aprilia	Tuareg 660	M18x1,5	silver - argento	T010_SI

Aprilia	RS 660	M20x1,5	black - nero	T011_BK
Aprilia	RS 660	M20x1,5	blue - blu	T011_BL
Aprilia	RS 660	M20x1,5	gold - oro	T011_GO
Aprilia	RS 660	M20x1,5	green - verde	T011_GR
Aprilia	RS 660	M20x1,5	orange - arancio	T011_OR
Aprilia	RS 660	M20x1,5	red - rosso	T011_RE
Aprilia	RS 660	M20x1,5	silver - argento	T011_SI

BMW	-	M24x2	black - nero	T004_BK
BMW	-	M24x2	blue - blu	T004_BL
BMW	-	M24x2	gold - oro	T004_GO
BMW	-	M24x2	green - verde	T004_GR
BMW	-	M24x2	orange - arancio	T004_OR
BMW	-	M24x2	red - rosso	T004_RE
BMW	-	M24x2	silver - argento	T004_SI

BRAND	MODEL - MODELLO	THREAD - FILETTO	COLOUR- COLORE	CODE - CODICE
Ducati	universal	M22x1,5	black - nero	T001_BK
Ducati	universal	M22x1,5	blue - blu	T001_BL
Ducati	universal	M22x1,5	gold - oro	T001_GO
Ducati	universal	M22x1,5	green - verde	T001_GR
Ducati	universal	M22x1,5	orange - arancio	T001_OR
Ducati	universal	M22x1,5	red - rosso	T001_RE
Ducati	universal	M22x1,5	silver - argento	T001_SI

Ducati	Hypermotard 821 - Monster 821/1100/1200 Streetfighter 848 - Streetfighter V2 1299 Panigale/V2	M20x2,5	black - nero	T008_BK	35,00
Ducati	Hypermotard 821 - Monster 821/1100/1200 Streetfighter 848 - Streetfighter V2 1299 Panigale/V2	M20x2,5	blue - blu	T008_BL	35,00
Ducati	Hypermotard 821 - Monster 821/1100/1200 Streetfighter 848 - Streetfighter V2 1299 Panigale/V2	M20x2,5	gold - oro	T008_GO	35,00
Ducati	Hypermotard 821 - Monster 821/1100/1200 Streetfighter 848 - Streetfighter V2 1299 Panigale/V2	M20x2,5	green - verde	T008_GR	35,00
Ducati	Hypermotard 821 - Monster 821/1100/1200 Streetfighter 848 - Streetfighter V2 1299 Panigale/V2	M20x2,5	orange - arancio	T008_OR	35,00
Ducati	Hypermotard 821 - Monster 821/1100/1200 Streetfighter 848 - Streetfighter V2 1299 Panigale/V2	M20x2,5	red - rosso	T008_RE	35,00
Ducati	Hypermotard 821 - Monster 821/1100/1200 Streetfighter 848 - Streetfighter V2 1299 Panigale/V2	M20x2,5	silver - argento	T008_SI	35,00

BRAND MODEL - MODELLO THREAD - FILETTO COLOUR- COLORE CODE - CODICE

Ducati	Panigale V4/V4S/V4R - 848/1098/1198 - 899/1199 Panigale	M19,5 x 2,5	black - nero	T003_BK
Ducati	Panigale V4/V4S/V4R - 848/1098/1198 - 899/1199 Panigale	M19,5 x 2,5	blue - blu	T003_BL
Ducati	Panigale V4/V4S/V4R - 848/1098/1198 - 899/1199 Panigale	M19,5 x 2,5	gold - oro	T003_GO
Ducati	Panigale V4/V4S/V4R - 848/1098/1198 - 899/1199 Panigale	M19,5 x 2,5	green - verde	T003_GR
Ducati	Panigale V4/V4S/V4R - 848/1098/1198 - 899/1199 Panigale	M19,5 x 2,5	orange - arancio	T003_OR
Ducati	Panigale V4/V4S/V4R - 848/1098/1198 - 899/1199 Panigale	M19,5 x 2,5	red - rosso	T003_RE
Ducati	Panigale V4/V4S/V4R - 848/1098/1198 - 899/1199 Panigale	M19,5 x 2,5	silver - argento	T003_SI

Honda	universal	M19,5 x 2,5	black - nero	T003_BK
Honda	universal	M19,5 x 2,5	blue - blu	T003_BL
Honda	universal	M19,5 x 2,5	gold - oro	T003_GO
Honda	universal	M19,5 x 2,5	green - verde	T003_GR
Honda	universal	M19,5 x 2,5	orange - arancio	T003_OR
Honda	universal	M19,5 x 2,5	red - rosso	T003_RE
Honda	universal	M19,5 x 2,5	silver - argento	T003_SI

Kawasaki	universal	M30x1,5	black - nero	T002_BK
Kawasaki	universal	M30x1,5	blue - blu	T002_BL
Kawasaki	universal	M30x1,5	gold - oro	T002_GO
Kawasaki	universal	M30x1,5	green - verde	T002_GR
Kawasaki	universal	M30x1,5	orange - arancio	T002_OR
Kawasaki	universal	M30x1,5	red - rosso	T002_RE
Kawasaki	universal	M30x1,5	silver - argento	T002_SI

Kawasaki	Ninja 250/400 - Z650 - Z800/900 - Z1000 (14/15) ZX-4R/RR (23->)	M20x2,5	black - nero	T008_BK
Kawasaki	Ninja 250/400 - Z650 - Z800/900 - Z1000 (14/15) ZX-4R/RR (23->)	M20x2,5	blue - blu	T008_BL
Kawasaki	Ninja 250/400 - Z650 - Z800/900 - Z1000 (14/15) ZX-4R/RR (23->)	M20x2,5	gold - oro	T008_GO
Kawasaki	Ninja 250/400 - Z650 - Z800/900 - Z1000 (14/15) ZX-4R/RR (23->)	M20x2,5	green - verde	T008_GR
Kawasaki	Ninja 250/400 - Z650 - Z800/900 - Z1000 (14/15) ZX-4R/RR (23->)	M20x2,5	orange - arancio	T008_OR
Kawasaki	Ninja 250/400 - Z650 - Z800/900 - Z1000 (14/15) ZX-4R/RR (23->)	M20x2,5	red - rosso	T008_RE
Kawasaki	Ninja 250/400 - Z650 - Z800/900 - Z1000 (14/15) ZX-4R/RR (23->)	M20x2,5	silver - argento	T008_SI

Suzuki	universal	M20x1,5	black - nero	T005_BK
Suzuki	universal	M20x1,5	blue - blu	T005_BL
Suzuki	universal	M20x1,5	gold - oro	T005_GO
Suzuki	universal	M20x1,5	green - verde	T005_GR
Suzuki	universal	M20x1,5	orange - arancio	T005_OR
Suzuki	universal	M20x1,5	red - rosso	T005_RE
Suzuki	universal	M20x1,5	silver - argento	T005_SI

BRAND MODEL - MODELLO THREAD - FILETTO COLOUR- COLORE CODE - CODICE

Triumph	universal	M19,5x2,5	black - nero	T003_BK
Triumph	universal	M19,5x2,5	blue - blu	T003_BL
Triumph	universal	M19,5x2,5	gold - oro	T003_GO
Triumph	universal	M19,5x2,5	green - verde	T003_GR
Triumph	universal	M19,5x2,5	orange - arancio	T003_OR
Triumph	universal	M19,5x2,5	red - rosso	T003_RE
Triumph	universal	M19,5x2,5	silver - argento	T003_SI

Triumph	Street Triple 765 - Speed Triple 1200 RS/RR	M20x2,5	black - nero	T009_BK
Triumph	Street Triple 765 - Speed Triple 1200 RS/RR	M20x2,5	blue - blu	T009_BL
Triumph	Street Triple 765 - Speed Triple 1200 RS/RR	M20x2,5	gold - oro	T009_GO
Triumph	Street Triple 765 - Speed Triple 1200 RS/RR	M20x2,5	green - verde	T009_GR
Triumph	Street Triple 765 - Speed Triple 1200 RS/RR	M20x2,5	orange - arancio	T009_OR
Triumph	Street Triple 765 - Speed Triple 1200 RS/RR	M20x2,5	red - rosso	T009_RE
Triumph	Street Triple 765 - Speed Triple 1200 RS/RR	M20x2,5	silver - argento	T009_SI

Yamaha	universal	M27x3	black - nero	T007_BK
Yamaha	universal	M27x3	blue - blu	T007_BL
Yamaha	universal	M27x3	gold - oro	T007_GO
Yamaha	universal	M27x3	green - verde	T007_GR
Yamaha	universal	M27x3	orange - arancio	T007_OR
Yamaha	universal	M27x3	red - rosso	T007_RE
Yamaha	universal	M27x3	silver - argento	T007_SI

Yamaha	MT-03	M19,5x2,5	black - nero	T003_BK
Yamaha	MT-03	M19,5x2,5	blue - blu	T003_BL
Yamaha	MT-03	M19,5x2,5	gold - oro	T003_GO
Yamaha	MT-03	M19,5x2,5	green - verde	T003_GR
Yamaha	MT-03	M19,5x2,5	orange - arancio	T003_OR
Yamaha	MT-03	M19,5x2,5	red - rosso	T003_RE
Yamaha	MT-03	M19,5x2,5	silver - argento	T003_SI

Yamaha	MT-09 (2013->)	M20x2,5	black - nero	T008_BK
Yamaha	MT-09 (2013->)	M20x2,5	blue - blu	T008_BL
Yamaha	MT-09 (2013->)	M20x2,5	gold - oro	T008_GO
Yamaha	MT-09 (2013->)	M20x2,5	green - verde	T008_GR
Yamaha	MT-09 (2013->)	M20x2,5	orange - arancio	T008_OR
Yamaha	MT-09 (2013->)	M20x2,5	red - rosso	T008_RE
Yamaha	MT-09 (2013->)	M20x2,5	silver - argento	T008_SI

TANK CAPS - TAPPI SERBATOIO



blue blu bronze bronzo gold oro green verde orange arancio red rosso silver argento

SPARE PART - RICAMBI

DESCRIPTION - DESCRIZIONE	COLOUR - COLORE	CODE - CODICE
Center cap - Tappo centrale	black - nero	FC00C_BK
Center cap - Tappo centrale	blue - blu	FC00C_BL
Center cap - Tappo centrale	bronze - bronzo	FC00C_BR
Center cap - Tappo centrale	gold - oro	FC00C_GO
Center cap - Tappo centrale	green - verde	FC00C_GR
Center cap - Tappo centrale	orange - arancio	FC00C_OR
Center cap - Tappo centrale	red - rosso	FC00C_RE
Center cap - Tappo centrale	silver - argento	FC00C_SI

BRAND	MODEL - MODELLO	FROM - DAL	TO - AL	COLOUR - COLORE	CODE - CODICE
APRILIA	RS 660 / TUONO 660	2020	>	black - nero	FC090_BK
APRILIA	RS 660 / TUONO 660	2020	>	blue - blu	FC090_BL
APRILIA	RS 660 / TUONO 660	2020	>	bronze - bronzo	FC090_BR
APRILIA	RS 660 / TUONO 660	2020	>	gold - oro	FC090_GO
APRILIA	RS 660 / TUONO 660	2020	>	green - verde	FC090_GR
APRILIA	RS 660 / TUONO 660	2020	>	orange - arancio	FC090_OR
APRILIA	RS 660 / TUONO 660	2020	>	red - rosso	FC090_RE
APRILIA	RS 660 / TUONO 660	2020	>	silver - argento	FC090_SI

APRILIA	RSV 1000 / RSV4 / TUONO / RSV4 Factory	2004	>	black - nero	FC030_BK
APRILIA	RSV 1000 / RSV4 / TUONO / RSV4 Factory	2004	>	blue - blu	FC030_BL
APRILIA	RSV 1000 / RSV4 / TUONO / RSV4 Factory	2004	>	bronze - bronzo	FC030_BR
APRILIA	RSV 1000 / RSV4 / TUONO / RSV4 Factory	2004	>	gold - oro	FC030_GO
APRILIA	RSV 1000 / RSV4 / TUONO / RSV4 Factory	2004	>	green - verde	FC030_GR
APRILIA	RSV 1000 / RSV4 / TUONO / RSV4 Factory	2004	>	orange - arancio	FC030_OR
APRILIA	RSV 1000 / RSV4 / TUONO / RSV4 Factory	2004	>	red - rosso	FC030_RE
APRILIA	RSV 1000 / RSV4 / TUONO / RSV4 Factory	2004	>	silver - argento	FC030_SI

TANK CAPS - TAPPI SERBATOIO

BRAND	MODEL - MODELLO	FROM - DAL	TO - AL	COLOUR- COLORE	CODE - CODICE
BMW	S 1000 R - M 1000 R - S 1000 RR - M 1000RR - HP4	2008	>	black - nero	FC040_BK
BMW	S 1000 R - M 1000 R - S 1000 RR - M 1000RR - HP4	2008	>	blue - blu	FC040_BL
BMW	S 1000 R - M 1000 R - S 1000 RR - M 1000RR - HP4	2008	>	bronze - bronzo	FC040_BR
BMW	S 1000 R - M 1000 R - S 1000 RR - M 1000RR - HP4	2008	>	gold - oro	FC040_GO
BMW	S 1000 R - M 1000 R - S 1000 RR - M 1000RR - HP4	2008	>	green - verde	FC040_GR
BMW	S 1000 R - M 1000 R - S 1000 RR - M 1000RR - HP4	2008	>	orange - arancio	FC040_OR
BMW	S 1000 R - M 1000 R - S 1000 RR - M 1000RR - HP4	2008	>	red - rosso	FC040_RE
BMW	S 1000 R - M 1000 R - S 1000 RR - M 1000RR - HP4	2008	>	silver - argento	FC040_SI

DUCATI	748 / 916 / 996 / 998 / 848 / 1098	-	-	black - nero	FC010_BK
DUCATI	748 / 916 / 996 / 998 / 848 / 1098	-	-	blue - blu	FC010_BL
DUCATI	748 / 916 / 996 / 998 / 848 / 1098	-	-	bronze - bronzo	FC010_BR
DUCATI	748 / 916 / 996 / 998 / 848 / 1098	-	-	gold - oro	FC010_GO
DUCATI	748 / 916 / 996 / 998 / 848 / 1098	-	-	green - verde	FC010_GR
DUCATI	748 / 916 / 996 / 998 / 848 / 1098	-	-	orange - arancio	FC010_OR
DUCATI	748 / 916 / 996 / 998 / 848 / 1098	-	-	red - rosso	FC010_RE
DUCATI	748 / 916 / 996 / 998 / 848 / 1098	-	-	silver - argento	FC010_SI

DUCATI	Panigale 899 / 1199 / 1299 / V2/ V4/ V4R	2012	>	black - nero	FC050_BK
DUCATI	Panigale 899 / 1199 / 1299 / V2/ V4/ V4R	2012	>	blue - blu	FC050_BL
DUCATI	Panigale 899 / 1199 / 1299 / V2/ V4/ V4R	2012	>	bronze - bronzo	FC050_BR
DUCATI	Panigale 899 / 1199 / 1299 / V2/ V4/ V4R	2012	>	gold - oro	FC050_GO
DUCATI	Panigale 899 / 1199 / 1299 / V2/ V4/ V4R	2012	>	green - verde	FC050_GR
DUCATI	Panigale 899 / 1199 / 1299 / V2/ V4/ V4R	2012	>	orange - arancio	FC050_OR
DUCATI	Panigale 899 / 1199 / 1299 / V2/ V4/ V4R	2012	>	red - rosso	FC050_RE
DUCATI	Panigale 899 / 1199 / 1299 / V2/ V4/ V4R	2012	>	silver - argento	FC050_SI

DUCATI	Streetfighter / Scrambler 800	2009	>	black - nero	FC050_BK
DUCATI	Streetfighter / Scrambler 800	2009	>	blue - blu	FC050_BL
DUCATI	Streetfighter / Scrambler 800	2009	>	bronze - bronzo	FC050_BR
DUCATI	Streetfighter / Scrambler 800	2009	>	gold - oro	FC050_GO
DUCATI	Streetfighter / Scrambler 800	2009	>	green - verde	FC050_GR
DUCATI	Streetfighter / Scrambler 800	2009	>	orange - arancio	FC050_OR
DUCATI	Streetfighter / Scrambler 800	2009	>	red - rosso	FC050_RE
DUCATI	Streetfighter / Scrambler 800	2009	>	silver - argento	FC050_SI

HONDA	CBR 500 R - CBR 650 R/F	2012	2023	black - nero	FC120_BK
HONDA	CBR 500 R - CBR 650 R/F	2012	2023	blue - blu	FC120_BL
HONDA	CBR 500 R - CBR 650 R/F	2012	2023	bronze - bronzo	FC120_BR
HONDA	CBR 500 R - CBR 650 R/F	2012	2023	gold - oro	FC120_GO
HONDA	CBR 500 R - CBR 650 R/F	2012	2023	green - verde	FC120_GR
HONDA	CBR 500 R - CBR 650 R/F	2012	2023	orange - arancio	FC120_OR
HONDA	CBR 500 R - CBR 650 R/F	2012	2023	red - rosso	FC120_RE
HONDA	CBR 500 R - CBR 650 R/F	2012	2023	silver - argento	FC120_SI

BRAND	MODEL - MODELLO	FROM - DAL	TO - AL	COLOUR- COLORE	CODE - CODICE
HONDA	CBR 600 RR	2003	>	black - nero	FC160_BK
HONDA	CBR 600 RR	2003	>	blue - blu	FC160_BL
HONDA	CBR 600 RR	2003	>	bronze - bronzo	FC160_BR
HONDA	CBR 600 RR	2003	>	gold - oro	FC160_GO
HONDA	CBR 600 RR	2003	>	green - verde	FC160_GR
HONDA	CBR 600 RR	2003	>	orange - arancio	FC160_OR
HONDA	CBR 600 RR	2003	>	red - rosso	FC160_RE
HONDA	CBR 600 RR	2003	>	silver - argento	FC160_SI

HONDA	CBR 1000 RR	2004	2013	black - nero	FC160_BK
HONDA	CBR 1000 RR	2004	2013	blue - blu	FC160_BL
HONDA	CBR 1000 RR	2004	2013	bronze - bronzo	FC160_BR
HONDA	CBR 1000 RR	2004	2013	gold - oro	FC160_GO
HONDA	CBR 1000 RR	2004	2013	green - verde	FC160_GR
HONDA	CBR 1000 RR	2004	2013	orange - arancio	FC160_OR
HONDA	CBR 1000 RR	2004	2013	red - rosso	FC160_RE
HONDA	CBR 1000 RR	2004	2013	silver - argento	FC160_SI

HONDA	CBR 1000 RR	2014	2016	black - nero	FC150_BK
HONDA	CBR 1000 RR	2014	2016	blue - blu	FC150_BL
HONDA	CBR 1000 RR	2014	2016	bronze - bronzo	FC150_BR
HONDA	CBR 1000 RR	2014	2016	gold - oro	FC150_GO
HONDA	CBR 1000 RR	2014	2016	green - verde	FC150_GR
HONDA	CBR 1000 RR	2014	2016	orange - arancio	FC150_OR
HONDA	CBR 1000 RR	2014	2016	red - rosso	FC150_RE
HONDA	CBR 1000 RR	2014	2016	silver - argento	FC150_SI

HONDA	CBR 1000 RR Fireblade/RR-R	2017	>	black - nero	FC120_BK
HONDA	CBR 1000 RR Fireblade/RR-R	2017	>	blue - blu	FC120_BL
HONDA	CBR 1000 RR Fireblade/RR-R	2017	>	bronze - bronzo	FC120_BR
HONDA	CBR 1000 RR Fireblade/RR-R	2017	>	gold - oro	FC120_GO
HONDA	CBR 1000 RR Fireblade/RR-R	2017	>	green - verde	FC120_GR
HONDA	CBR 1000 RR Fireblade/RR-R	2017	>	orange - arancio	FC120_OR
HONDA	CBR 1000 RR Fireblade/RR-R	2017	>	red - rosso	FC120_RE
HONDA	CBR 1000 RR Fireblade/RR-R	2017	>	silver - argento	FC120_SI

KAWASAKI	Ninja 250/400 - ZX-4R/RR	2018	2023	black - nero	FC170_BK
KAWASAKI	Ninja 250/400 - ZX-4R/RR	2018	2023	blue - blu	FC170_BL
KAWASAKI	Ninja 250/400 - ZX-4R/RR	2018	2023	bronze - bronzo	FC170_BR
KAWASAKI	Ninja 250/400 - ZX-4R/RR	2018	2023	gold - oro	FC170_GO
KAWASAKI	Ninja 250/400 - ZX-4R/RR	2018	2023	green - verde	FC170_GR
KAWASAKI	Ninja 250/400 - ZX-4R/RR	2018	2023	orange - arancio	FC170_OR
KAWASAKI	Ninja 250/400 - ZX-4R/RR	2018	2023	red - rosso	FC170_RE
KAWASAKI	Ninja 250/400 - ZX-4R/RR	2018	2023	silver - argento	FC170_SI

TANK CAPS - TAPPI SERBATOIO

BRAND	MODEL - MODELLO	FROM - DAL	TO - AL	COLOUR- COLORE	CODE - CODICE
KAWASAKI	ZX-6R	2007	2017	black - nero	FC070_BK
KAWASAKI	ZX-6R	2007	2017	blue - blu	FC070_BL
KAWASAKI	ZX-6R	2007	2017	bronze - bronzo	FC070_BR
KAWASAKI	ZX-6R	2007	2017	gold - oro	FC070_GO
KAWASAKI	ZX-6R	2007	2017	green - verde	FC070_GR
KAWASAKI	ZX-6R	2007	2017	orange - arancio	FC070_OR
KAWASAKI	ZX-6R	2007	2017	red - rosso	FC070_RE
KAWASAKI	ZX-6R	2007	2017	silver - argento	FC070_SI

KAWASAKI	ZX-6R	2019	>	black - nero	FC170_BK
KAWASAKI	ZX-6R	2019	>	blue - blu	FC170_BL
KAWASAKI	ZX-6R	2019	>	bronze - bronzo	FC170_BR
KAWASAKI	ZX-6R	2019	>	gold - oro	FC170_GO
KAWASAKI	ZX-6R	2019	>	green - verde	FC170_GR
KAWASAKI	ZX-6R	2019	>	orange - arancio	FC170_OR
KAWASAKI	ZX-6R	2019	>	red - rosso	FC170_RE
KAWASAKI	ZX-6R	2019	>	silver - argento	FC170_SI

KAWASAKI	ZX-10R	2006	2020	black - nero	FC070_BK
KAWASAKI	ZX-10R	2006	2020	blue - blu	FC070_BL
KAWASAKI	ZX-10R	2006	2020	bronze - bronzo	FC070_BR
KAWASAKI	ZX-10R	2006	2020	gold - oro	FC070_GO
KAWASAKI	ZX-10R	2006	2020	green - verde	FC070_GR
KAWASAKI	ZX-10R	2006	2020	orange - arancio	FC070_OR
KAWASAKI	ZX-10R	2006	2020	red - rosso	FC070_RE
KAWASAKI	ZX-10R	2006	2020	silver - argento	FC070_SI

KAWASAKI	ZX-10R	2021	>	black - nero	FC170_BK
KAWASAKI	ZX-10R	2021	>	blue - blu	FC170_BL
KAWASAKI	ZX-10R	2021	>	bronze - bronzo	FC170_BR
KAWASAKI	ZX-10R	2021	>	gold - oro	FC170_GO
KAWASAKI	ZX-10R	2021	>	green - verde	FC170_GR
KAWASAKI	ZX-10R	2021	>	orange - arancio	FC170_OR
KAWASAKI	ZX-10R	2021	>	red - rosso	FC170_RE
KAWASAKI	ZX-10R	2021	>	silver - argento	FC170_SI

KAWASAKI	ER-6N/Z 800/Z 1000	2007	2016	black - nero	FC070_BK
KAWASAKI	ER-6N/Z 800/Z 1000	2007	2016	blue - blu	FC070_BL
KAWASAKI	ER-6N/Z 800/Z 1000	2007	2016	bronze - bronzo	FC070_BR
KAWASAKI	ER-6N/Z 800/Z 1000	2007	2016	gold - oro	FC070_GO
KAWASAKI	ER-6N/Z 800/Z 1000	2007	2016	green - verde	FC070_GR
KAWASAKI	ER-6N/Z 800/Z 1000	2007	2016	orange - arancio	FC070_OR
KAWASAKI	ER-6N/Z 800/Z 1000	2007	2016	red - rosso	FC070_RE
KAWASAKI	ER-6N/Z 800/Z 1000	2007	2016	silver - argento	FC070_SI

BRAND	MODEL - MODELLO	FROM - DAL	TO - AL	COLOUR- COLORE	CODE - CODICE
KAWASAKI	Z650/Z900	2017	>	black - nero	FC170_BK
KAWASAKI	Z650/Z900	2017	>	blue - blu	FC170_BL
KAWASAKI	Z650/Z900	2017	>	bronze - bronzo	FC170_BR
KAWASAKI	Z650/Z900	2017	>	gold - oro	FC170_GO
KAWASAKI	Z650/Z900	2017	>	green - verde	FC170_GR
KAWASAKI	Z650/Z900	2017	>	orange - arancio	FC170_OR
KAWASAKI	Z650/Z900	2017	>	red - rosso	FC170_RE
KAWASAKI	Z650/Z900	2017	>	silver - argento	FC170_SI

KTM	RC 390/390 Duke/790-890 Duke	2018	2023	black - nero	FC200_BK
KTM	RC 390/390 Duke/790-890 Duke	2018	2023	blue - blu	FC200_BL
KTM	RC 390/390 Duke/790-890 Duke	2018	2023	bronze - bronzo	FC200_BR
KTM	RC 390/390 Duke/790-890 Duke	2018	2023	gold - oro	FC200_GO
KTM	RC 390/390 Duke/790-890 Duke	2018	2023	green - verde	FC200_GR
KTM	RC 390/390 Duke/790-890 Duke	2018	2023	orange - arancio	FC200_OR
KTM	RC 390/390 Duke/790-890 Duke	2018	2023	red - rosso	FC200_RE
KTM	RC 390/390 Duke/790-890 Duke	2018	2023	silver - argento	FC200_SI

KTM	1290 Super Duke R	2013	2023	black - nero	FC210_BK
KTM	1290 Super Duke R	2013	2023	blue - blu	FC210_BL
KTM	1290 Super Duke R	2013	2023	bronze - bronzo	FC210_BR
KTM	1290 Super Duke R	2013	2023	gold - oro	FC210_GO
KTM	1290 Super Duke R	2013	2023	green - verde	FC210_GR
KTM	1290 Super Duke R	2013	2023	orange - arancio	FC210_OR
KTM	1290 Super Duke R	2013	2023	red - rosso	FC210_RE
KTM	1290 Super Duke R	2013	2023	silver - argento	FC210_SI

MV AGUSTA	F3 675/800 - Brutale 675/800	2011	2018	black - nero	FC090_BK
MV AGUSTA	F3 675/800 - Brutale 675/800	2011	2018	blue - blu	FC090_BL
MV AGUSTA	F3 675/800 - Brutale 675/800	2011	2018	bronze - bronzo	FC090_BR
MV AGUSTA	F3 675/800 - Brutale 675/800	2011	2018	gold - oro	FC090_GO
MV AGUSTA	F3 675/800 - Brutale 675/800	2011	2018	green - verde	FC090_GR
MV AGUSTA	F3 675/800 - Brutale 675/800	2011	2018	orange - arancio	FC090_OR
MV AGUSTA	F3 675/800 - Brutale 675/800	2011	2018	red - rosso	FC090_RE
MV AGUSTA	F3 675/800 - Brutale 675/800	2011	2018	silver - argento	FC090_SI

MV AGUSTA	F4 - Brutale	1997	2009	black - nero	FC190_BK
MV AGUSTA	F4 - Brutale	1997	2009	blue - blu	FC190_BL
MV AGUSTA	F4 - Brutale	1997	2009	bronze - bronzo	FC190_BR
MV AGUSTA	F4 - Brutale	1997	2009	gold - oro	FC190_GO
MV AGUSTA	F4 - Brutale	1997	2009	green - verde	FC190_GR
MV AGUSTA	F4 - Brutale	1997	2009	orange - arancio	FC190_OR
MV AGUSTA	F4 - Brutale	1997	2009	red - rosso	FC190_RE
MV AGUSTA	F4 - Brutale	1997	2009	silver - argento	FC190_SI

TANK CAPS - TAPPI SERBATOIO

BRAND	MODEL - MODELLO	FROM - DAL	TO - AL	COLOUR- COLORE	CODE - CODICE
MV AGUSTA	F4 - Brutale	2010	2019	black - nero	FC130_BK
MV AGUSTA	F4 - Brutale	2010	2019	blue - blu	FC130_BL
MV AGUSTA	F4 - Brutale	2010	2019	bronze - bronzo	FC130_BR
MV AGUSTA	F4 - Brutale	2010	2019	gold - oro	FC130_GO
MV AGUSTA	F4 - Brutale	2010	2019	green - verde	FC130_GR
MV AGUSTA	F4 - Brutale	2010	2019	orange - arancio	FC130_OR
MV AGUSTA	F4 - Brutale	2010	2019	red - rosso	FC130_RE
MV AGUSTA	F4 - Brutale	2010	2019	silver - argento	FC130_SI

SUZUKI	GSX-R 600/750	2004	2018	black - nero	FC080_BK
SUZUKI	GSX-R 600/750	2004	2018	blue - blu	FC080_BL
SUZUKI	GSX-R 600/750	2004	2018	bronze - bronzo	FC080_BR
SUZUKI	GSX-R 600/750	2004	2018	gold - oro	FC080_GO
SUZUKI	GSX-R 600/750	2004	2018	green - verde	FC080_GR
SUZUKI	GSX-R 600/750	2004	2018	orange - arancio	FC080_OR
SUZUKI	GSX-R 600/750	2004	2018	red - rosso	FC080_RE
SUZUKI	GSX-R 600/750	2004	2018	silver - argento	FC080_SI

SUZUKI	GSX-R 1000	2003	>	black - nero	FC080_BK
SUZUKI	GSX-R 1000	2003	>	blue - blu	FC080_BL
SUZUKI	GSX-R 1000	2003	>	bronze - bronzo	FC080_BR
SUZUKI	GSX-R 1000	2003	>	gold - oro	FC080_GO
SUZUKI	GSX-R 1000	2003	>	green - verde	FC080_GR
SUZUKI	GSX-R 1000	2003	>	orange - arancio	FC080_OR
SUZUKI	GSX-R 1000	2003	>	red - rosso	FC080_RE
SUZUKI	GSX-R 1000	2003	>	silver - argento	FC080_SI

SUZUKI	GSX-S 750 (2015/>)	GSX-S 1000 (2021/>)		black - nero	FC080_BK
SUZUKI	GSX-S 750 (2015/>)	GSX-S 1000 (2021/>)		blue - blu	FC080_BL
SUZUKI	GSX-S 750 (2015/>)	GSX-S 1000 (2021/>)		bronze - bronzo	FC080_BR
SUZUKI	GSX-S 750 (2015/>)	GSX-S 1000 (2021/>)		gold - oro	FC080_GO
SUZUKI	GSX-S 750 (2015/>)	GSX-S 1000 (2021/>)		green - verde	FC080_GR
SUZUKI	GSX-S 750 (2015/>)	GSX-S 1000 (2021/>)		orange - arancio	FC080_OR
SUZUKI	GSX-S 750 (2015/>)	GSX-S 1000 (2021/>)		red - rosso	FC080_RE
SUZUKI	GSX-S 750 (2015/>)	GSX-S 1000 (2021/>)		silver - argento	FC080_SI

SUZUKI	GSX-8S/8R	2023	>	black - nero	FC080_BK
SUZUKI	GSX-8S/8R	2023	>	blue - blu	FC080_BL
SUZUKI	GSX-8S/8R	2023	>	bronze - bronzo	FC080_BR
SUZUKI	GSX-8S/8R	2023	>	gold - oro	FC080_GO
SUZUKI	GSX-8S/8R	2023	>	green - verde	FC080_GR
SUZUKI	GSX-8S/8R	2023	>	orange - arancio	FC080_OR
SUZUKI	GSX-8S/8R	2023	>	red - rosso	FC080_RE
SUZUKI	GSX-8S/8R	2023	>	silver - argento	FC080_SI

BRAND	MODEL - MODELLO	FROM - DAL	TO - AL	COLOUR- COLORE	CODE - CODICE
TRIUMPH	Street Triple - Daytona - Speed Triple* (all M.Y.)	-	-	black - nero	FC220_BK
TRIUMPH	Street Triple - Daytona - Speed Triple* (all M.Y.)	-	-	blue - blu	FC220_BL
TRIUMPH	Street Triple - Daytona - Speed Triple* (all M.Y.)	-	-	bronze - bronzo	FC220_BR
TRIUMPH	Street Triple - Daytona - Speed Triple* (all M.Y.)	-	-	gold - oro	FC220_GO
TRIUMPH	Street Triple - Daytona - Speed Triple* (all M.Y.)	-	-	green - verde	FC220_GR
TRIUMPH	Street Triple - Daytona - Speed Triple* (all M.Y.)	-	-	orange - arancio	FC220_OR
TRIUMPH	Street Triple - Daytona - Speed Triple* (all M.Y.)	-	-	red - rosso	FC220_RE
TRIUMPH	Street Triple - Daytona - Speed Triple* (all M.Y.)	-	-	silver - argento	FC220_SI

YAMAHA	YZF R3	2015	>	black - nero	FC110_BK
YAMAHA	YZF R3	2015	>	blue - blu	FC110_BL
YAMAHA	YZF R3	2015	>	bronze - bronzo	FC110_BR
YAMAHA	YZF R3	2015	>	gold - oro	FC110_GO
YAMAHA	YZF R3	2015	>	green - verde	FC110_GR
YAMAHA	YZF R3	2015	>	orange - arancio	FC110_OR
YAMAHA	YZF R3	2015	>	red - rosso	FC110_RE
YAMAHA	YZF R3	2015	>	silver - argento	FC110_SI

YAMAHA	YZF R6 - YZF R1/R1M	1998	>	black - nero	FC110_BK
YAMAHA	YZF R6 - YZF R1/R1M	1998	>	blue - blu	FC110_BL
YAMAHA	YZF R6 - YZF R1/R1M	1998	>	bronze - bronzo	FC110_BR
YAMAHA	YZF R6 - YZF R1/R1M	1998	>	gold - oro	FC110_GO
YAMAHA	YZF R6 - YZF R1/R1M	1998	>	green - verde	FC110_GR
YAMAHA	YZF R6 - YZF R1/R1M	1998	>	orange - arancio	FC110_OR
YAMAHA	YZF R6 - YZF R1/R1M	1998	>	red - rosso	FC110_RE
YAMAHA	YZF R6 - YZF R1/R1M	1998	>	silver - argento	FC110_SI

YAMAHA	MT-03/MT-07/MT-09	-	-	black - nero	FC110_BK
YAMAHA	MT-03/MT-07/MT-09	-	-	blue - blu	FC110_BL
YAMAHA	MT-03/MT-07/MT-09	-	>	bronze - bronzo	FC110_BR
YAMAHA	MT-03/MT-07/MT-09	-	>	gold - oro	FC110_GO
YAMAHA	MT-03/MT-07/MT-09	-	>	green - verde	FC110_GR
YAMAHA	MT-03/MT-07/MT-09	-	>	orange - arancio	FC110_OR
YAMAHA	MT-03/MT-07/MT-09	-	>	red - rosso	FC110_RE
YAMAHA	MT-03/MT-07/MT-09	-	>	silver - argento	FC110_SI

YAMAHA	YZF R7	2021	>	black - nero	FC110_BK
YAMAHA	YZF R7	2021	>	blue - blu	FC110_BL
YAMAHA	YZF R7	2021	>	bronze - bronzo	FC110_BR
YAMAHA	YZF R7	2021	>	gold - oro	FC110_GO
YAMAHA	YZF R7	2021	>	green - verde	FC110_GR
YAMAHA	YZF R7	2021	>	orange - arancio	FC110_OR
YAMAHA	YZF R7	2021	>	red - rosso	FC110_RE
YAMAHA	YZF R7	2021	>	silver - argento	FC110_SI

* not compatible with the Speed Triple 1200 RS 2021/> and Speed Triple 1200 RR 2022/> models
* non compatibile con i modelli Speed Triple 1200 RS 2021/> e Speed Triple 1200 RR 2022/>

BONAMICI RACING CLOTHING - ABBIGLIAMENTO



DESCRIPTION - DESCRIZIONE

CODE - CODICE

SIZE - TAGLIA

T-SHIRT

TSH01

S - M - L - XL - XXL



DESCRIPTION - DESCRIZIONE

CODE - CODICE

Cap - Cappello

CAP01







DESCRIPTION - DESCRIZIONE

CODE - CODICE

Brake fluid reservoir sock cover
Polsino serbatoio Liquido Freno

PLS01



DESCRIPTION - DESCRIZIONE

CODE - CODICE

Rubber key ring Bonamici Racing Logo
Portachiavi in gomma Logo Bonamici Racing

KRG01





MODELS - MODELLI



MODELS MODELLI

INDEX MODELS - INDICE MODELLI

APRILIA RSV4 (2021/>)	104
APRILIA RSV4 (2017/2020)	105
APRILIA RS 660 / TUONO 660 (2020/>)	106
BMW S 1000 RR (2017/2018)	107
BMW S 1000 RR (2019/ 2022)	108
BMW S 1000 RR (2023/>)	109
BMW M 1000 RR (2021/>)	110
BMW S 1000 R - M 1000 R (2021/>)	111
BMW S 1000 XR (2020/>)	112
DUCATI 899/959/1199/1299 PANIGALE	113
DUCATI PANIGALE V2	114
DUCATI PANIGALE V4/V4S/V4R	115
DUCATI STREETFIGHTER V2	116
DUCATI STREETFIGHTER V4/V4S	117
HONDA CBR 1000 RR FIREBLADE (2017/2019)	118
HONDA CBR 1000 RR-R FIREBLADE (2020/>)	119
NEW HONDA CBR 600 RR (2024/>)	120
KAWASAKI ZX-10R (2016/2020)	121
KAWASAKI ZX-10R (2021/>)	122
KAWASAKI NINJA 400	123
KAWASAKI ZX-4RR (2023/>)	124
KAWASAKI Z650	125
KAWASAKI Z900	126
KTM 790/890 DUKE	127
KTM 1290 SUPER DUKE (2017/2019)	128
KTM 1290 SUPER DUKE R (2020/2023)	129
KTM 1390 SUPER DUKE R (2024/>)	130
SUZUKI GSX-R 1000 (2017/>)	131
SUZUKI GSX-S 1000 (2021/>)	132
NEW SUZUKI GSX-8R (2023/>)	133
NEW SUZUKI GSX-8S (2023/>)	134
TRIUMPH STREET TRIPLE (2017/2022)	135
TRIUMPH STREET TRIPLE 765 R (2023/>)	136
TRIUMPH STREET TRIPLE 765 RS/MOTO 2 EDITION (2023/>)	137
TRIUMPH SPEED TRIPLE 1200 RS (2021/>)	138
TRIUMPH SPEED TRIPLE 1200 RR (2022/>)	139
YAMAHA YZF R1 (2015/2019)	140
YAMAHA YZF R1 (2020/>)	141
YAMAHA YZF R6 (2017/>)	142
YAMAHA YZF R7 (2021/>)	143
YAMAHA YZF R3	144
YAMAHA MT-09	145



DESCRIPTION - DESCRIZIONE

CODE - CODICE

Rearset (normal shifting) - Pedane (cambio normale)	A005S
Rearset (reverse shifting) - Pedane (cambio rovesciato)	A005SR
Engine protections - Protezioni motore	CP107
Dashboard protection - Protezione strumentazione	DCP13
Lifted handlebars - Semimanubri rialzati	SM51A
Top triple clamp "Street" - Piastra di sterzo superiore "Street"	PSA1
Top triple clamp "Race" - Piastra di sterzo superiore "Race"	PSA1R
Brake lever - Leva freno	LB110
Brake lever with remote adjuster - Leva freno con registro a sx	RALB110
Clutch lever - Leva frizione	LC010
Full clutch lever - Leva frizione completa	LCF
Adjustable full clutch lever - Leva frizione completa regolabile	LCFR
Levers kit - Kit leve	KL010
EVO lever protection (without adaptor) - Protezione leva EVO (senza adattatore)	LPRR2_BK
Lever protection (without adaptor) - Protezione leva (senza adattatore)	LPRR_B_BK
Carbon lever protection (without adaptor) - Protezione leva in carbonio (senza adattatore)	LPLITE1_R
Tank cap (black) - Tappo serbatoio (nero)	FC030_BK
10 ml Oil tank - Serbatoio olio 10 ml	VS10P_BK
Chain adjuster - Tendicatena	CHAD13_BK
Swingarms spools - Supporti cavalletto	SCS6_BK
Swingarms spools "racing" - Supporti cavalletto "racing"	SCR6_BK



DESCRIPTION - DESCRIZIONE

CODE - CODICE

Rearset (normal shifting) - Pedane (cambio normale)	A005S
Rearset (reverse shifting) - Pedane (cambio rovesciato)	A005SR
Dashboard protection - Protezione strumentazione	DCP06
Unlifted handlebars - Semimanubri bassi	SM51B
Lifted handlebars - Semimanubri rialzati	SM51
Top triple clamp "Street" - Piastra di sterzo superiore "Street"	PSA1
Top triple clamp "Race" - Piastra di sterzo superiore "Race"	PSA1R
Brake lever - Leva freno	LB110
Brake lever with remote adjuster - Leva freno con registro a sx	RALB110
Clutch lever - Leva frizione	LC010
Full clutch lever - Leva frizione completa	LCF
Adjustable full clutch lever - Leva frizione completa regolabile	LCFR
Levers kit - Kit leve	KL010
EVO lever protection (without adaptor) - Protezione leva EVO (senza adattatore)	LPRR2_BK
Lever protection (without adaptor) Protezione leva (senza adattatore)	LPRR_B_BK
Carbon lever protection (without adaptor) - Protezione leva in carbonio (senza adattatore)	LPLITE1_R
Tank cap (black) - Tappo serbatoio (nero)	FC030_BK
10 ml Oil tank - Serbatoio olio 10 ml	VS10P_BK
Chain adjuster - Tendicatena	CHAD04_BK
Swingarms spools - Supporti cavalletto	SCS6_BK
Swingarms spools "racing" - Supporti cavalletto "racing"	SCR6_BK



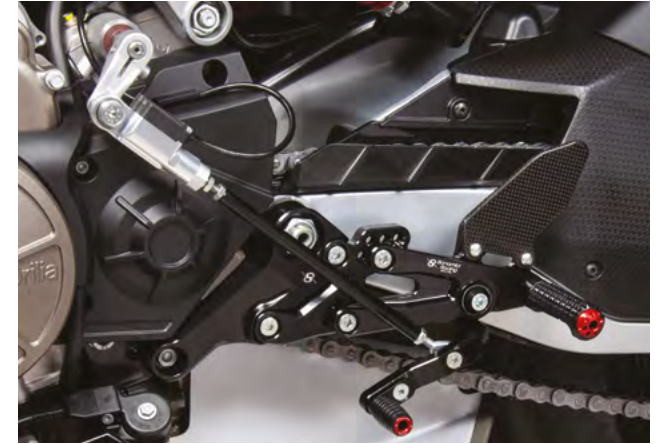

DESCRIPTION - DESCRIZIONE

CODE - CODICE

Rearset - Pedane	A006
Dashboard protection - Protezione strumentazione	DCP12
Lifted handlebars (only for RS 660) - Semimanubri rialzati (solo per RS 660)	SM51A
Steering stops - Coppia battute di sterzo	BS02
Top triple clamp (only for RS 660) - Piastra di sterzo superiore (solo per RS 660)	PSA2
Engine protections - Protezioni motore	CP114
Brake lever - Leva freno	LB110
Brake lever with remote adjuster - Leva freno con registro a sx	RALB110
Clutch lever - Leva frizione	LC010
Full clutch lever - Leva frizione completa	LCF
Adjustable full clutch lever - Leva frizione completa regolabile	LCFR
Levers kit - Kit leve	KL010
EVO lever protection (without adaptor) - Protezione leva EVO (senza adattatore)	LPRR2_BK
Lever protection (without adaptor) - Protezione leva (senza adattatore)	LPRR_B_BK
Carbon lever protection (without adaptor) - Protezione leva in carbonio (senza adattatore)	LPLITE1_R
Tank cap (black) - Tappo serbatoio (nero)	FC090_BK
10 ml Oil tank - Serbatoio olio 10 ml	VS10P_BK
Chain adjuster - Tendicatena	CHAD12_BK
Swingarms spools - Supporti cavalletto	SCS6_BK
Swingarms spools "racing" - Supporti cavalletto "racing"	SCR6_BK
Oil cap - Tappo olio	T011_BK



DESCRIPTION - DESCRIZIONE

CODE - CODICE

Rearset - Pedane	B005
Top triple clamp "Street" - Piastra di sterzo superiore "Street"	PSB1
Top triple clamp "Race" - Piastra di sterzo superiore "Race"	PSB1R
Unlifted handlebars - Semimanubri bassi	SM55B
Lifted handlebars - Semimanubri rialzati	SM55
Brake lever - Leva freno	LB090
Brake lever with remote adjuster - Leva freno con registro a sx	RALB090
Clutch lever - Leva frizione	LC140
Full clutch lever - Leva frizione completa	LCF
Adjustable full clutch lever - Leva frizione completa regolabile	LCFR
Levers kit - Kit leve	KL220
EVO lever protection (without adaptor) - Protezione leva EVO (senza adattatore)	LPRR2_BK
Lever protection (without adaptor) Protezione leva (senza adattatore)	LPRR_B_BK
Carbon lever protection (without adaptor) - Protezione leva in carbonio (senza adattatore)	LPLITE1_R
Tank cap - Tappo serbatoio	FC040
10 ml Oil tank - Serbatoio olio 10 ml	VS10P_BK
Chain adjuster - Tendicatena	CHAD01_BK
Swingarms spools - Supporti cavalletto	SCS8_BK
Swingarms spools "racing" - Supporti cavalletto "racing"	SCR8_BK
Oil cap - Tappo olio	T004_BK





* Handlebars to use the OEM triple clamp (include the steering plate bracelets)

* Semimanubri utilizzabili con la piastra di sterzo originale (Include i bracciali per la piastra di sterzo)

** Handlebars to use with Bonamici Racing top triple clamp (not include the clamps for steering plate)

** Semimanubri utilizzabili con la piastra di sterzo Bonamici Racing (non include la coppia di supporti ad arco per la piastra di sterzo)

*** The brake lever may touch with the knob on the instrument frame, when the motorcycle is understeer.

The plastic protection cannot be remounted on the clutch lever.

*** La leva freno quando la moto è sottosterzo, potrebbe toccare con il pomello sul telaio porta strumentazione.

Non è possibile rimontare la protezione in plastica sulla leva frizione.

DESCRIPTION - DESCRIZIONE

CODE - CODICE

Rearset - Pedane	B007
Top triple clamp "Street"- Piastra di sterzo superiore "Street"	PSB2
Top triple clamp "Race" - Piastra di sterzo superiore "Race"	PSB2R
Engine protections "racing" 5 pcs. - Protezioni motore "racing" 5pz.	CP086B
Lifted handlebars* - Semimanubri rialzati*	SM55S1K
Lifted handlebars** - Semimanubri rialzati**	SM55S1KW
Brake lever*** - Leva freno***	LB090
Brake lever with remote adjuster - Leva freno con registro a sx	RALB090
Clutch lever*** - Leva frizione***	LC170
Full clutch lever - Leva frizione completa	LCF
Adjustable full clutch lever - Leva frizione completa regolabile	LCFR
Levers kit*** - Kit leve***	KL290
EVO lever protection (without adaptor) - Protezione leva EVO (senza adattatore)	LPRR2_BK
Lever protection (without adaptor) - Protezione leva (senza adattatore)	LPRR_B_BK
Carbon lever protection (without adaptor) - Protezione leva in carbonio (senza adattatore)	LPLITE1_R
Dashboard protection - Protezione strumentazione	DCP08
Tank cap (black) - Tappo serbatoio (nero)	FC040_BK
10 ml Oil tank - Serbatoio olio 10 ml	VS10P_BK
Oil cap - Tappo olio	T004_BK
Chain adjuster - Tendicatena	CHAD09_BK
Swingarms spools - Supporti cavalletto	SCS8_BK
Swingarms spools "racing" - Supporti cavalletto "racing"	SCR8_BK
Block mirror - Tappi specchio	BM07_BK
Gear spacer support - Supporto distanziale cambio	DC_039B

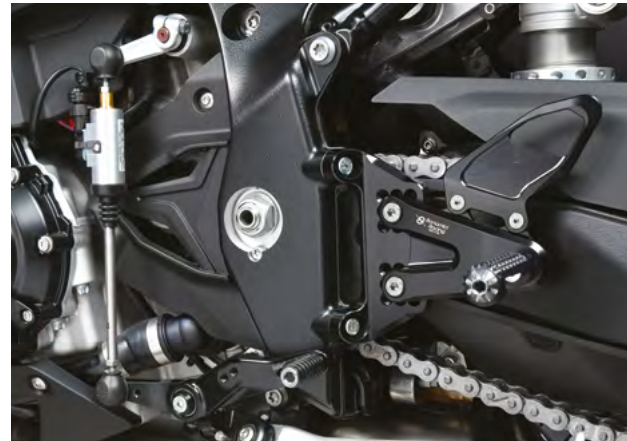

DESCRIPTION - DESCRIZIONE

CODE - CODICE

Rearset - Pedane	B007
Top triple clamp "Street" - Piastra di sterzo superiore "Street"	PSB3
Top triple clamp "Race" - Piastra di sterzo superiore "Race"	PSB3R
Engine protections "racing" 5 pcs. - Protezioni motore "racing" 5pz.	CP086B
Lifted handlebars* - Semimanubri rialzati*	SM55S1K
Lifted handlebars** - Semimanubri rialzati**	SM55S1KW
Brake lever*** - Leva freno***	LB090
Brake lever with remote adjuster - Leva freno con registro a sx	RALB090
Clutch lever*** - Leva frizione***	LC170
Full clutch lever - Leva frizione completa	LCF
Adjustable full clutch lever - Leva frizione completa regolabile	LCFR
Levers kit*** - Kit leve***	KL290
EVO lever protection (without adaptor) - Protezione leva EVO (senza adattatore)	LPRR2_BK
Lever protection (without adaptor) - Protezione leva (senza adattatore)	LPRR_B_BK
Carbon lever protection (without adaptor) - Protezione leva in carbonio (senza adattatore)	LPLITE1_R
Dashboard protection - Protezione strumentazione	DCP08
Tank cap (black) - Tappo serbatoio (nero)	FC040_BK
10 ml Oil tank - Serbatoio olio 10 ml	VS10P_BK
Oil cap - Tappo olio	T004_BK
Chain adjuster - Tendicatena	CHAD09_BK
Swingarms spools - Supporti cavalletto	SCS8_BK
Swingarms spools "racing" - Supporti cavalletto "racing"	SCR8_BK
Block mirror - Tappi specchio	BM07_BK
Gear spacer support - Supporto distanziale cambio	DC_039B



* Handlebars to use the OEM triple clamp (include the steering plate bracelets)

* Semimanubri utilizzabili con la piastra di sterzo originale (Include i bracciali per la piastra di sterzo)

** Handlebars to use with Bonamici Racing top triple clamp (not include the clamps for steering plate)

** Semimanubri utilizzabili con la piastra di sterzo Bonamici Racing (non Include la coppia di supporti ad arco per la piastra di sterzo)

*** The brake lever may touch with the knob on the instrument frame, when the motorcycle is understeer.

The plastic protection cannot be remounted on the clutch lever.

*** La leva freno quando la moto è sottosterzo, potrebbe toccare con il pomello sul telaio porta strumentazione.

Non è possibile rimontare la protezione in plastica sulla leva frizione.



* Handlebars to use the OEM triple clamp (include the steering plate bracelets)

* Semimanubri utilizzabili con la piastra di sterzo originale (Include i bracciali per la piastra di sterzo)

** Handlebars to use with Bonamici Racing top triple clamp (not include the clamps for steering plate)

** Semimanubri utilizzabili con la piastra di sterzo Bonamici Racing (non Include la coppia di supporti ad arco per la piastra di sterzo)

*** The brake lever may touch with the knob on the instrument frame, when the motorcycle is understeer.

The plastic protection cannot be remounted on the clutch lever.

*** La leva freno quando la moto è sottosterzo, potrebbe toccare con il pomello sul telaio porta strumentazione.

Non è possibile rimontare la protezione in plastica sulla leva frizione.

DESCRIPTION - DESCRIZIONE

CODE - CODICE

Rearset - Pedane	B007
Top triple clamp "Street"- Piastra di sterzo superiore "Street"	PSB3
Top triple clamp "Race" - Piastra di sterzo superiore "Race"	PSB3R
Engine protections "racing" 5 pcs. - Protezioni motore "racing" 5pz.	CP086B
Lifted handlebars* - Semimanubri rialzati*	SM55S1K
Lifted handlebars** - Semimanubri rialzati**	SM55S1KW
Brake lever*** - Leva freno***	LB090
Brake lever with remote adjuster - Leva freno con registro a sx	RALB090
Clutch lever*** - Leva frizione***	LC170
Full clutch lever - Leva frizione completa	LCF
Adjustable full clutch lever - Leva frizione completa regolabile	LCFR
Levers kit*** - Kit leve***	KL290
EVO lever protection (without adaptor) - Protezione leva EVO (senza adattatore)	LPRR2_BK
Lever protection (without adaptor) Protezione leva (senza adattatore)	LPRR_B_BK
Carbon lever protection (without adaptor) - Protezione leva in carbonio (senza adattatore)	LPLITE1_R
Dashboard protection - Protezione strumentazione (2021-2022 models)	DCP08
Tank cap (black) - Tappo serbatoio (nero)	FC040_BK
10 ml Oil tank - Serbatoio olio 10 ml	VS10P_BK
Oil cap - Tappo olio	T004_BK
Swingarms spools "racing" - Supporti cavalletto "racing"	SCR8_BK
Gear spacer support - Supporto distanziale cambio	DC_039B

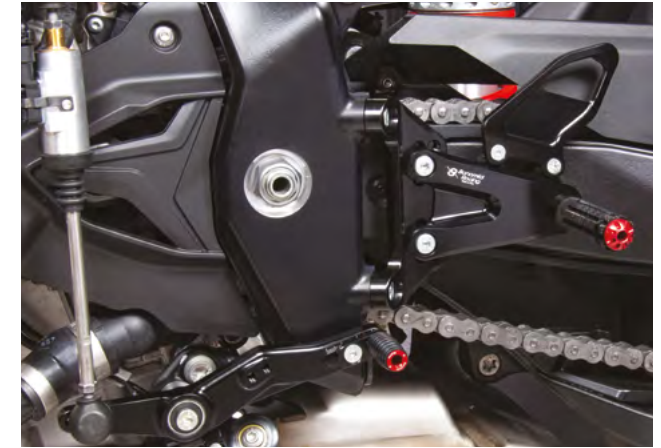

DESCRIPTION - DESCRIZIONE

CODE - CODICE

Rearset - Pedane	B008
Engine protections "racing" 5 pcs. - Protezioni motore "racing" 5pz.	CP086B
Brake lever - Leva freno	LB200
Brake lever with remote adjuster - Leva freno con registro a sx	RALB200
Clutch lever - Leva frizione *	LC170
Full clutch lever - Leva frizione completa	LCF
Adjustable full clutch lever - Leva frizione completa regolabile	LCFR
Levers kit - Kit leve *	KL270
Dashboard protection - Protezione strumentazione	DCP08
Tank cap (black) - Tappo serbatoio (nero)	FC040_BK
10 ml Oil tank - Serbatoio olio 10 ml	VS10P_BK
Oil cap - Tappo olio	T004_BK
Chain adjuster - Tendicatena	CHAD09_BK
Swingarms spools - Supporti cavalletto	SCS8_BK
Swingarms spools "racing" - Supporti cavalletto "racing"	SCR8_BK
Gear spacer support - Supporto distanziale cambio	DC_039B

* The plastic protection cannot be remounted on the clutch lever.

* Non è possibile rimontare la protezione in plastica sulla leva frizione.



Some items can be purchased in colors other than standard black - Alcuni articoli possono essere acquistati in colori diversi dal nero standard



DESCRIPTION - DESCRIZIONE

CODE - CODICE

Rearset - Pedane	B009
Engine protections 4pcs. - Protezioni motore 4pz.	CP116
Brake lever - Leva freno	LB200
Clutch lever - Leva frizione *	LC170
Levers kit - Kit leve *	KL270
Dashboard protection - Protezione strumentazione	DCP08
Oil cap - Tappo olio	T004_BK

* The plastic protection cannot be remounted on the clutch lever.

* Non è possibile rimontare la protezione in plastica sulla leva frizione.



DESCRIPTION - DESCRIZIONE

CODE - CODICE

Rearset - Pedane	DV2
Engine protections (for 959) - Protezioni motore (per 959)	CP009B
Engine protections (for 1199/1299) - Protezioni motore (per1199/1299)	CP009A
Unlifted handlebars ø53mm - Semimanubri bassi ø53mm	SM53B
Unlifted handlebars for 1199S - Semimanubri bassi per 1199S	SM53PA
Lifted handlebars ø53mm - Semimanubri rialzati ø53mm	SM53
Brake lever - Leva freno	LB140
Brake lever with remote adjuster - Leva freno con registro a sx	RALB140
Clutch lever - Leva frizione	LC061
Levers kit - Kit leve	KL031
EVO lever protection (without adaptor) - Protezione leva EVO (senza adattatore)	LPRR2_BK
Lever protection (without adaptor) Protezione leva (senza adattatore)	LPRR_B_BK
Carbon lever protection (without adaptor) - Protezione leva in carbonio (senza adattatore)	LPLITE1_R
Tank cap (black) - Tappo serbatoio (nero)	FC050_BK
Oil cap (899/1199) - Tappo olio (899/1199)	T008_BK
Oil cap (1299) - Tappo olio (1299)	T008_BK
10 ml Oil tank - Serbatoio olio 10 ml	VS10P_BK



DUCATI PANIGALE V2



DESCRIPTION - DESCRIZIONE

CODE - CODICE

Rearset - Pedane (2020-2024 models)	DV2
Engine protections - Protezioni motore (2020-2024 models)	CP105
Engine protections - Protezioni motore "Racing" * (2020-2024 models)	CP122
Handlebars with steering damper bracket Semimanubri con bracciale per ammortizzatore di sterzo (2020-2024 models)	SM53PV2
Top triple clamp - Piastra di sterzo superiore (2020-2024 models)	PSV2
Dashboard protection - Protezione strumentazione (2020-2024 models)	DCP11
Levers kit - Kit leve (2020-2022 models)	KL031
Brake lever - Leva freno (2020-2022 models)	LB140
Brake lever with remote adjuster - Leva freno con registro a sx (2020-2022 models)	RALB140
Levers kit - Kit leve (2023- > models)	KL380
Brake lever - Leva freno (2023- > models)	LB240
Brake lever with remote adjuster - Leva freno con registro a sx (2023- > models)	RALB240
Clutch lever - Leva frizione (2020- > models)	LC061
EVO lever protection (without adaptor) - Protezione leva EVO (senza adattatore) (2020- > models)	LPRR2_BK
Lever protection (without adaptor) Protezione leva (senza adattatore) (2020- > models)	LPRR_B_BK
Carbon lever protection (without adaptor) - Protezione leva in carbonio (senza adattatore) (2020- > models)	LPLITE1_R
Tank cap - Tappo serbatoio (2020- > models)	FC050_BK
10 ml Oil tank - Serbatoio olio 10 ml (2020- > models)	VS10P_BK
Oil cap - Tappo olio (2020- > models)	T008_BK
Block mirror - Tappi specchio (2020-2024 models)	BM06_BK

* Installation is possible only on racing racing fairings - * L'installazione è possibile solo su carene racing



DESCRIPTION - DESCRIZIONE

CODE - CODICE

Rearset - Pedane (2018-2024 models)	DV4
Engine protections - Protezioni motore (V4/V4S) (2018-2024 models)	CP081
Engine protections - Protezioni motore (V4R) (2018-2024 models)	CP081B
Handlebars with steering damper bracket (V4/V4S) Semimanubri con bracciale per ammortizzatore di sterzo (V4/V4S) (2018-2024 models)	SM53PV4
Handlebars with steering damper bracket (V4R) Semimanubri con bracciale per ammortizzatore di sterzo (V4R) (2018-2024 models)	SM53PV4R
Top triple clamp - Piastra di sterzo superiore (V4/V4S 2018-> models) (V4R 2019-2022 models)	PSV4
Dashboard protection - Protezione strumentazione (2018-2024 models)	DCP03
Brake lever - Leva freno (2018-2022 models)	LB140
Brake lever - Leva freno (2023 -> models)	LB240
Brake lever with remote adjuster - Leva freno con registro a sx (2018 - 2022 models)	RALB140
Brake lever with remote adjuster - Leva freno con registro a sx (2023 -> models)	RALB240
Brake lever with racing remote adjuster - Leva freno con registro racing a sx (2018 - 2022 models)	RALB140R
Brake lever with racing remote adjuster - Leva freno con registro racing a sx (2023 -> models)	RALB240R
Clutch lever - Leva frizione (2018-> models)	LC061
Levers kit - Kit leve (2018-2022 models)	KL031
Levers kit - Kit leve (2023-> models)	KL380
EVO lever protection (without adaptor) - Protezione leva EVO (senza adattatore) (2018-> models)	LPRR2_BK
Lever protection (without adaptor) Protezione leva (senza adattatore) (2018-> models)	LPRR_B_BK
Carbon lever protection (without adaptor) Protezione leva in carbonio (senza adattatore) (2018-> models)	LPLITE1_R
Tank cap (black) - Tappo serbatoio (nero) (2018-> models)	FC050_BK
10 ml Oil tank - Serbatoio olio 10 ml (2018-> models)	VS10P_BK
Oil cap - Tappo olio (2018-> models)	T003_BK
Block mirror - Tappi specchio (2018-2024 models)	BM06_BK



Some items can be purchased in colors other than standard black - Alcuni articoli possono essere acquistati in colori diversi dal nero standard

DUCATI STREETFIGHTER V2 (2022->)



DESCRIPTION - DESCRIZIONE

CODE - CODICE

Rearset - Pedane	DSTR3
Dashboard protection - Protezione strumentazione	DCP11
Brake lever - Leva freno	LB240
Brake lever with remote adjuster - Leva freno con registro a sx	RALB240
Brake lever with racing remote adjuster - Leva freno con registro racing a sx	RALB240R
Clutch lever - Leva frizione	LC061
Levers kit - Kit leve	KL380
EVO lever protection (without adaptor) - Protezione leva EVO (senza adattatore)	LPRR2_BK
Lever protection (without adaptor) - Protezione leva (senza adattatore)	LPRR_B_BK
Carbon lever protection (without adaptor) - Protezione leva in carbonio (senza adattatore)	LPLITE1_R
Tank cap - Tappo serbatoio	FC050_BK
10 ml Oil tank - Serbatoio olio 10 ml	VS10P_BK
Oil cap - Tappo olio	T008_BK



DESCRIPTION - DESCRIZIONE

CODE - CODICE

Rearset - Pedane	DSTR2
Engine protections - Protezioni motore (2020-2022)	CP103
Engine protections - Protezioni motore (2023->)	CP081
Dashboard protection - Protezione strumentazione	DCP10
Brake lever - Leva freno (2020 / 2022 models)	LB140
Brake lever - Leva freno (2023 / > models)	LB240
Brake lever with remote adjuster - Leva freno con registro a sx (2020 / 2022 models)	RALB140
Brake lever with remote adjuster - Leva freno con registro a sx (2023 / > models)	RALB240
Clutch lever - Leva frizione	LC061
Levers kit - Kit leve (2020 / 2022 models)	KL031
Levers kit - Kit leve (2023 / > models)	KL380
EVO lever protection (without adaptor) - Protezione leva EVO (senza adattatore)	LPRR2_BK
Lever protection (without adaptor) - Protezione leva (senza adattatore)	LPRR_B_BK
Carbon lever protection (without adaptor) - Protezione leva in carbonio (senza adattatore)	LPLITE1_R
Tank cap (black) - Tappo serbatoio (nero)	FC050_BK
10 ml Oil tank - Serbatoio olio 10 ml	VS10P_BK
Oil cap - Tappo olio	T003_BK



HONDA CBR 1000 RR FIREBLADE 2017/2019



DESCRIPTION - DESCRIZIONE

CODE - CODICE

Rearset - Pedane	H013
Rearset (with QS) - Pedane (con quickshifter)	H014
Unlifted handlebars - Semimanubri bassi	SM50B
Lifted handlebars - Semimanubri rialzati	SM50
Top triple clamp "Street" - Piastra di sterzo superiore "Street"	PSH1
Top triple clamp "Race" - Piastra di sterzo superiore "Race"	PSH1R
Brake lever - Leva freno	LB150
Brake lever with remote adjuster - Leva freno con registro a sx	RALB150
Clutch lever - Leva frizione	LC020
Full clutch lever - Leva frizione completa	LCF
Adjustable full clutch lever - Leva frizione completa regolabile	LCFR
Levers kit - Kit leve	KL040
EVO lever protection (without adaptor) - Protezione leva EVO (senza adattatore)	LPRR2_BK
Lever protection (without adaptor) - Protezione leva (senza adattatore)	LPRR_B_BK
Carbon lever protection (without adaptor) - Protezione leva in carbonio (senza adattatore)	LPLITE1_R
Tank cap (black) - Tappo serbatoio (nero)	FC120_BK
Oil cap - Tappo olio	T003_BK
10 ml Oil tank - Serbatoio olio 10 ml	VS10P_BK
Swingarms spools - Supporti cavalletto	SCS8_BK
Swingarms spools "racing" - Supporti cavalletto "racing"	SCR8_BK

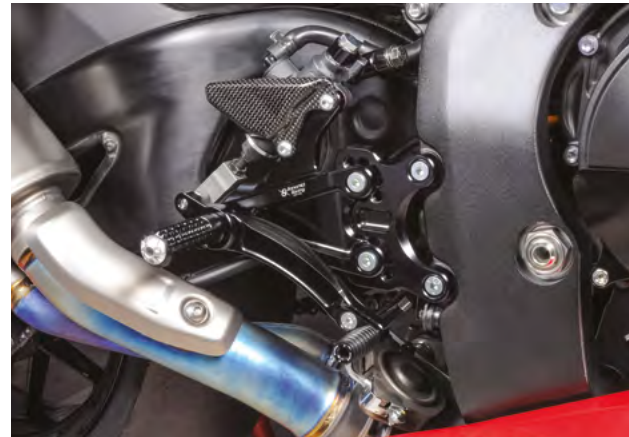

DESCRIPTION - DESCRIZIONE

CODE - CODICE

Rearset "Racing" - Pedane "Racing"	H015
Rearset "Standard" - Pedane "Standard"	H016
Gear spacer support - Supporto distanziale cambio	DC_040B
Engine protections - Protezioni motore	CP100
Unlifted handlebars - Semimanubri bassi	SM50B
Top triple clamp - Piastra di sterzo superiore	PSH2
Brake lever - Leva freno	LB150
Brake lever (for SP model) - Leva freno (per modello SP)	LB110
Brake lever with remote adjuster - Leva freno con registro a sx	RALB150
Brake lever with remote adj. (SP) - Leva freno con registro a sx (SP.)	RALB110
Clutch lever - Leva frizione	LC020
Full clutch lever - Leva frizione completa	LCF
Adjustable full clutch lever - Leva frizione completa regolabile	LCFR
Levers kit - Kit leve	KL040
Levers kit (for SP model) - Kit leve (per modello SP)	KL310
EVO lever protection (without adaptor) - Protezione leva EVO (senza adattatore)	LP RR2_BK
Lever protection (without adaptor) - Protezione leva (senza adattatore)	LP RR_B_BK
Carbon lever protection (without adaptor) - Protezione leva in carbonio (senza adattatore)	LP LITE1_R
Tank cap (black) - Tappo serbatoio (nero)	FC120_BK
Oil cap - Tappo olio	T003_BK
10 ml Oil tank - Serbatoio olio 10 ml	VS10P_BK
Chain adjuster - Tendicatena	CHAD10_BK
Dashboard protection - Protezione strumentazione	DCP09



CODE - CODICE

DESCRIPTION - DESCRIZIONE

Swingarms spools - Supporti cavalletto	SCS8_BK
Swingarms spools "racing" - Supporti cavalletto "racing"	SCR8_BK

Some items can be purchased in colors other than standard black - Alcuni articoli possono essere acquistati in colori diversi dal nero standard

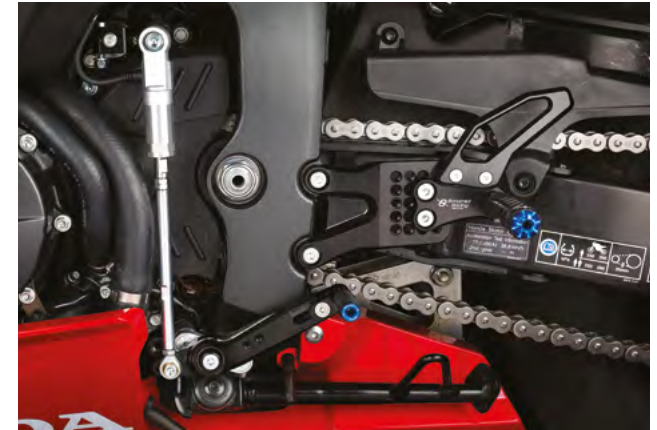

DESCRIPTION - DESCRIZIONE

CODE - CODICE

Rearset - Pedane	H018
Lifted handlebars - Semimanubri rialzati	SM48
Brake lever - Leva freno	LB150
Brake lever with remote adjuster - Leva freno con registro a sx	RALB150
Clutch lever - Leva frizione	LC020
Full clutch lever - Leva frizione completa	LCF
Adjustable full clutch lever - Leva frizione completa regolabile	LCFR
Levers kit - Kit leve	KL040
Dashboard protection - Protezione strumentazione	DCP23
EVO lever protection (without adaptor) - Protezione leva EVO (senza adattatore)	LPRR2_BK
Lever protection (without adaptor) - Protezione leva (senza adattatore)	LPRR_B_BK
Carbon lever protection (without adaptor) - Protezione leva in carbonio (senza adattatore)	LPLITE1_R
Tank cap - Tappo serbatoio	FC160_BK
Oil cap - Tappo olio	T003_BK
Chain adjuster - Tendicatena	CHAD14_BK
10 ml Oil tank - Serbatoio olio 10 ml	VS10P_BK
Swingarms spools - Supporti cavalletto	SCS8_BK
Swingarms spools "racing" - Supporti cavalletto "racing"	SCR8_BK



DESCRIPTION - DESCRIZIONE

CODE - CODICE

Rearset (normal shifting) - Pedane (cambio normale)	K015
Engine protections - Protezioni motore	CP012
Unlifted handlebars - Semimanubri bassi	SM50B
Lifted handlebars - Semimanubri rialzati	SM50
Top triple clamp "Street" - Piastra di sterzo superiore "Street"	PSK1
Top triple clamp "Race" - Piastra di sterzo superiore "Race"	PSK1R
Brake lever - Leva freno	LB110
Brake lever with remote adjuster - Leva freno con registro a sx	RALB110
Clutch lever - Leva frizione	LC040
Full clutch lever - Leva frizione completa	LCF
Adjustable full clutch lever - Leva frizione completa regolabile	LCFR
Levers kit - Kit leve	KL210
EVO lever protection (without adaptor) - Protezione leva EVO (senza adattatore)	LPRR2_BK
Lever protection (without adaptor) - Protezione leva (senza adattatore)	LPRR_B_BK
Carbon lever protection (without adaptor) - Protezione leva in carbonio (senza adattatore)	LPLITE1_R
Tank cap (black) - Tappo serbatoio (nero)	FC070_BK
Oil cap - Tappo olio	T002_BK
10 ml Oil tank - Serbatoio olio 10 ml	VS10P_BK
Chain adjuster - Tendicatena	CHAD02_BK
Swingarms spools - Supporti cavalletto	SCS8_BK
Swingarms spools "racing" - Supporti cavalletto "racing"	SCR8_BK

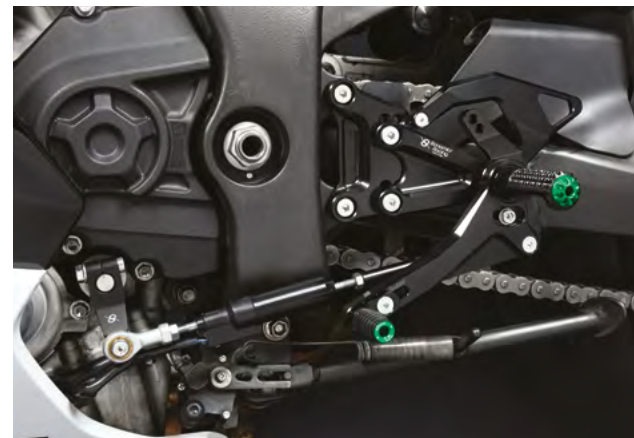

DESCRIPTION - DESCRIZIONE
CODE - CODICE

Rearset - Pedane	K021
Engine protections - Protezioni motore	CP012
Unlifted handlebars - Semimanubri bassi	SM50B
Lifted handlebars - Semimanubri rialzati	SM50
Dashboard protection - Protezione strumentazione	DCP20
Top triple clamp "Street" - Piastra di sterzo superiore "Street"	PSK3
Top triple clamp "Race" - Piastra di sterzo superiore "Race"	PSK3R
Brake lever - Leva freno	LB110
Brake lever with remote adjuster - Leva freno con registro a sx	RALB110
Brake lever with Racing remote adjuster - Leva freno con registro Racing a sx	RALB110R
Clutch lever - Leva frizione	LC040
Full clutch lever - Leva frizione completa	LCF
Adjustable full clutch lever - Leva frizione completa regolabile	LCFR
Levers kit - Kit leve	KL210
EVO lever protection (without adaptor) - Protezione leva EVO (senza adattatore)	LPRR2_BK
Lever protection (without adaptor) - Protezione leva (senza adattatore)	LPRR_B_BK
Carbon lever protection (without adaptor) - Protezione leva in carbonio (senza adattatore)	LPLITE1_R
Tank cap (black) - Tappo serbatoio (nero)	FC170_BK
Oil cap - Tappo olio	T002_BK
10 ml Oil tank - Serbatoio olio 10 ml	VS10P_BK
Chain adjuster - Tendicatena	CHAD02_BK
Swingarms spools - Supporti cavalletto	SCS8_BK
Swingarms spools "racing" - Supporti cavalletto "racing"	SCR8_BK





DESCRIPTION - DESCRIZIONE

CODE - CODICE

Rearset - Pedane		K019
Rearset - Pedane**	raised +25 mm compared to K019	K019_25
28 mm lifted handlebars* - Semimanubri rialzati di 28 mm*		SM41_30
Brake lever - Leva freno		LB180
Brake lever with remote adjuster - Leva freno con registro a sx		RALB180
Clutch lever - Leva frizione		LC160
Full clutch lever - Leva frizione completa		LCF
Adjustable full clutch lever - Leva frizione completa regolabile		LCFR
Levers kit - Kit leve		KL260
EVO lever protection (without adaptor) - Protezione leva EVO (senza adattatore)		LPRR2_BK
Lever protection (without adaptor) - Protezione leva (senza adattatore)		LPRR_B_BK
Carbon lever protection (without adaptor) - Protezione leva in carbonio (senza adattatore)		LPLITE1_R
Tank cap (black) - Tappo serbatoio (nero)		FC170_BK
Oil cap - Tappo olio		T008_BK
10 ml Oil tank - Serbatoio olio 10 ml		VS10P_BK
Swingarms spools - Supporti cavalletto		SCS8_BK
Swingarms spools "racing" - Supporti cavalletto "racing"		SCR8_BK



*It need to modify the original fairing - *Occorre modificare le carene originali
 **The brake hose needs to be replaced - ** È necessario sostituire il tubo freno

Some items can be purchased in colors other than standard black - Alcuni articoli possono essere acquistati in colori diversi dal nero standard



DESCRIPTION - DESCRIZIONE

CODE - CODICE

Rearset - Pedane	K022
Lifted handlebars - Semimanubri rialzati	SM54A
Dashboard protection - Protezione strumentazione	DPC20
Top triple clamp - Piastra di sterzo superiore	PSK2
Brake lever - Leva freno	LB260
Brake lever with remote adjuster - Leva freno con registro a sx	RALB260
Brake lever with Racing remote adjuster - Leva freno con registro Racing a sx	RALB260R
Clutch lever - Leva frizione	LC240
Full clutch lever - Leva frizione completa	LCF
Adjustable full clutch lever - Leva frizione completa regolabile	LCFR
Levers kit - Kit leve	KL410
EVO lever protection (without adaptor) - Protezione leva EVO (senza adattatore)	LPRR2_BK
Lever protection (without adaptor) - Protezione leva (senza adattatore)	LPRR_B_BK
Carbon lever protection (without adaptor) - Protezione leva in carbonio (senza adattatore)	LPLITE1_R
Tank cap (black) - Tappo serbatoio (nero)	FC170_BK
Oil cap - Tappo olio	T008_BK
10 ml Oil tank - Serbatoio olio 10 ml	VS10P_BK
Swingarms spools - Supporti cavalletto	SCS8_BK
Swingarms spools "racing" - Supporti cavalletto "racing"	SCR8_BK



DESCRIPTION - DESCRIZIONE

CODE - CODICE

Rearset - Pedane	K018
Full clutch lever - Leva frizione completa	LCF
Adjustable full clutch lever - Leva frizione completa regolabile	LCFR
EVO lever protection (without adaptor) - Protezione leva EVO (senza adattatore)	LPRR2_BK
Lever protection (without adaptor) - Protezione leva (senza adattatore)	LPRR_B_BK
Carbon lever protection (without adaptor) - Protezione leva in carbonio (senza adattatore)	LPLITE1_R
Tank cap (black) - Tappo serbatoio (nero)	FC170_BK
10 ml Oil tank - Serbatoio olio 10 ml	VS10P_BK
Swingarms spools - Supporti cavalletto	SCS8_BK
Swingarms spools "racing" - Supporti cavalletto "racing"	SCR8_BK





DESCRIPTION - DESCRIZIONE

CODE - CODICE

Rearset - Pedane	K023
Dashboard protection - Protezione strumentazione (2020/➤)	DCP24
Brake lever - Leva freno	LB260
Clutch lever - Leva frizione	LC240
Full clutch lever - Leva frizione completa	LCF
Adjustable full clutch lever - Leva frizione completa regolabile	LCFR
Levers kit - Kit leve	KL410
EVO lever protection (without adaptor) - Protezione leva EVO (senza adattatore)	LPRR2_BK
Lever protection (without adaptor) - Protezione leva (senza adattatore)	LPRR_B_BK
Carbon lever protection (without adaptor) - Protezione leva in carbonio (senza adattatore)	LPLITE1_R
10 ml Oil tank - Serbatoio olio 10 ml	VS10P_BK
Swingarms spools - Supporti cavalletto	SCS8_BK
Swingarms spools "racing" - Supporti cavalletto "racing"	SCR8_BK

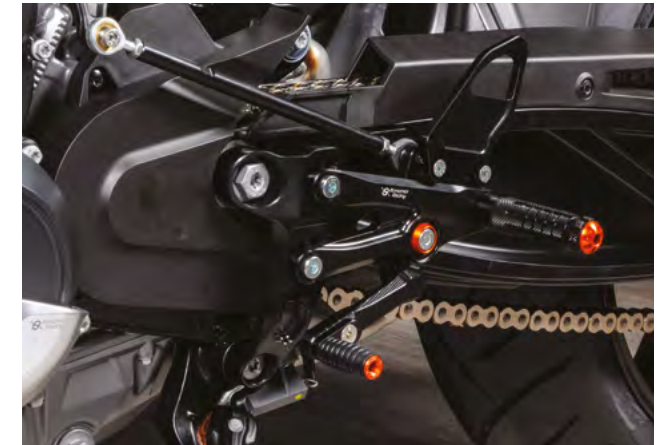

DESCRIPTION - DESCRIZIONE

CODE - CODICE

Rearset - Pedane	KT04
Engine protections - Protezioni motore (Duke 890)	CP093B
Levers kit - Kit leve	KL300
Brake lever - Leva freno	LB190
Clutch lever - Leva frizione	LC180
EVO lever protection (without adaptor) - Protezione leva EVO (senza adattatore)	LPRR2_BK
Lever protection (without adaptor) - Protezione leva (senza adattatore)	LPRR_B_BK
Carbon lever protection (without adaptor) - Protezione leva in carbonio (senza adattatore)	LPLITE1_R
Tank cap (black) - Tappo serbatoio (nero)	FC200_BK
10 ml Oil tank - Serbatoio olio 10 ml	VS10P_BK
Swingarm spools M10 x 1,5 - Supporti cavalletto M10 x 1,5	SCS10G_BK
Swingarm spools M10 x 1,5 "racing" - Supporti cavalletto M10 x 1,5 "racing"	SCR10G_BK





DESCRIPTION - DESCRIZIONE

CODE - CODICE

Rearset - Pedane	KT03
Engine protections - Protezioni motore	CP060
Full clutch lever - Leva frizione completa	LCF
Adjustable full clutch lever - Leva frizione completa regolabile	LCFR
EVO lever protection (without adaptor) - Protezione leva EVO (senza adattatore)	LPRR2_BK
Lever protection (without adaptor) - Protezione leva (senza adattatore)	LPRR_B_BK
Carbon lever protection (without adaptor) - Protezione leva in carbonio (senza adattatore)	LPLITE1_R
Tank cap (black) - Tappo serbatoio (nero)	FC210_BK
10 ml Oil tank - Serbatoio olio 10 ml	VS10P_BK

**DESCRIPTION - DESCRIZIONE****CODE - CODICE**

Rearset - Pedane	KT05
Engine protections - Protezioni motore	CP060
Levers kit - Kit leve	KL280
Brake lever - Leva freno	LB110
Clutch lever - Leva frizione	LC200
Full clutch lever - Leva frizione completa	LCF
Adjustable full clutch lever - Leva frizione completa regolabile	LCFR
EVO lever protection (without adaptor) - Protezione leva EVO (senza adattatore)	LP RR2_BK
Lever protection (without adaptor) - Protezione leva (senza adattatore)	LP RR_B_BK
Carbon lever protection (without adaptor) - Protezione leva in carbonio (senza adattatore)	LP LITE1_R
Tank cap (nero) - Tappo serbatoio (nero)	FC210_BK
10 ml Oil tank - Serbatoio olio 10 ml	VS10P_BK





DESCRIPTION - DESCRIZIONE

CODE - CODICE

Rearset - Pedane	KT06
Engine protections - Protezioni motore	CP124
Levers kit - Kit leve	KL420
Brake lever - Leva freno	LB210
Clutch lever - Leva frizione	LC061
EVO lever protection (without adaptor) - Protezione leva EVO (senza adattatore)	LPRR2_BK
Lever protection (without adaptor) - Protezione leva (senza adattatore)	LPRR_B_BK
Carbon lever protection (without adaptor) - Protezione leva in carbonio (senza adattatore)	LPLITE1_R
10 ml Oil tank - Serbatoio olio 10 ml	VS10P_BK



DESCRIPTION - DESCRIZIONE

CODE - CODICE

Rearset - Pedane	S011
Engine protections - Protezioni motore	CP070
Unlifted handlebars - Semimanubri bassi	SM50B
Lifted handlebars - Semimanubri rialzati	SM50
Dashboard protection - Protezione strumentazione	DCP05
Top triple clamp "Street" - Piastra di sterzo superiore "Street"	PSS1
Top triple clamp "Race" - Piastra di sterzo superiore "Race"	PSS1R
Brake lever - Leva freno	LB090
Brake lever with remote adjuster - Leva freno con registro a sx	RALB090
Clutch lever - Leva frizione	LC090
Full clutch lever - Leva frizione completa	LCF
Adjustable full clutch lever - Leva frizione completa regolabile	LCFR
Levers kit - Kit leve	KL170
EVO lever protection (without adaptor) - Protezione leva EVO (senza adattatore)	LPRR2_BK
Lever protection (without adaptor) - Protezione leva (senza adattatore)	LPRR_B_BK
Carbon lever protection (without adaptor) - Protezione leva in carbonio (senza adattatore)	LPLITE1_R
Tank cap (black) - Tappo serbatoio (nero)	FC080_BK
Oil cap - Tappo olio	T005_BK
10 ml Oil tank - Serbatoio olio 10 ml	VS10P_BK
Chain adjuster - Tendicatena	CHAD06_BK
Swingarms spools - Supporti cavalletto	SCS8_BK
Swingarms spools "racing" - Supporti cavalletto "racing"	SCR8_BK





DESCRIPTION - DESCRIZIONE

CODE - CODICE

Brake lever - Leva freno	LB201
Brake lever with remote adjuster - Leva freno con registro a sx	RALB201
Clutch lever - Leva frizione	LC210
Levers kit - Kit leve	KL330
EVO lever protection (without adaptor) - Protezione leva EVO (senza adattatore)	LPRR2_BK
Lever protection (without adaptor) - Protezione leva (senza adattatore)	LPRR_B_BK
Carbon lever protection (without adaptor) - Protezione leva in carbonio (senza adattatore)	LPLITE1_R
Dashboard protection - Protezione strumentazione	DCP05
Tank cap (black) - Tappo serbatoio (nero)	FC080_BK
10 ml Oil tank - Serbatoio olio 10 ml	VS10P_BK
Oil cap - Tappo olio	T005_BK
Chain adjuster - Tencicatena	CHAD06_BK
Swingarms spools - Supporti cavalletto	SCS8_BK
Swingarms spools "racing" - Supporti cavalletto "racing"	SCR8_BK

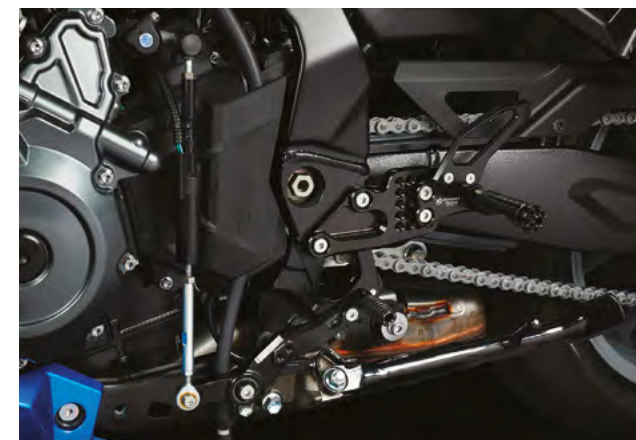

DESCRIPTION - DESCRIZIONE

CODE - CODICE

Rearset - Pedane	S014
Handlebars - Semimanubri they include steering stop code BS04 and steering plate caps code TPS01 comprendono battuta di sterzo codice BS04 e tappi piastria di sterzo codice TPS01	SM50A8R
Brake lever - Leva freno	LB201
Brake lever with remote adjuster - Leva freno con registro a sx	RALB201
Clutch lever - Leva frizione	LC250
Full clutch lever - Leva frizione completa	LCF
Adjustable full clutch lever - Leva frizione completa regolabile	LCFR
Levers kit - Kit leve	KL430
EVO lever protection (without adaptor) - Protezione leva EVO (senza adattatore)	LPRR2_BK
Lever protection (without adaptor) - Protezione leva (senza adattatore)	LPRR_B_BK
Carbon lever protection (without adaptor) - Protezione leva in carbonio (senza adattatore)	LPLITE1_R
Tank cap (black) - Tappo serbatoio (nero)	FC080_BK
Oil cap - Tappo olio	T005_BK
10 ml Oil tank - Serbatoio olio 10 ml	VS10P_BK
Swingarms spools - Supporti cavalletto	SCS8_BK
Swingarms spools "racing" - Supporti cavalletto "racing"	SCR8_BK





DESCRIPTION - DESCRIZIONE

CODE - CODICE

Rearset - Pedane	S014
Brake lever - Leva freno	LB201
Brake lever with remote adjuster - Leva freno con registro a sx	RALB201
Clutch lever - Leva frizione	LC250
Full clutch lever - Leva frizione completa	LCF
Adjustable full clutch lever - Leva frizione completa regolabile	LCFR
Levers kit - Kit leve	KL430
EVO lever protection (without adaptor) - Protezione leva EVO (senza adattatore)	LPRR2_BK
Lever protection (without adaptor) - Protezione leva (senza adattatore)	LPRR_B_BK
Carbon lever protection (without adaptor) - Protezione leva in carbonio (senza adattatore)	LPLITE1_R
Tank cap - Tappo serbatoio	FC080_BK
Oil cap - Tappo olio	T005_BK
10 ml Oil tank - Serbatoio olio 10 ml	VS10P_BK
Swingarms spools - Supporti cavalletto	SCS8_BK
Swingarms spools "racing" - Supporti cavalletto "racing"	SCR8_BK

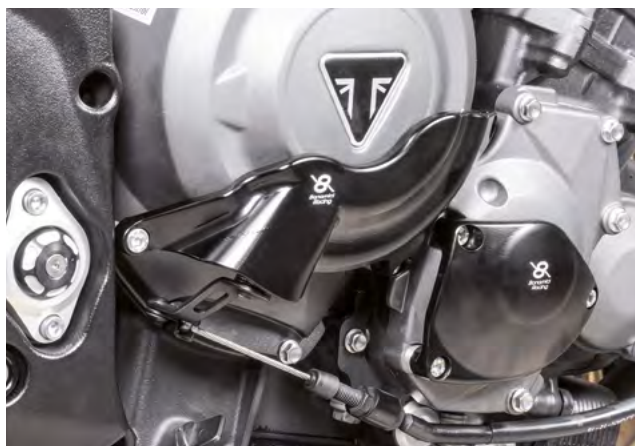

DESCRIPTION - DESCRIZIONE

CODE - CODICE

Rearset - Pedane	TH06
Engine protections - Protezioni motore	CP074
Full clutch lever - Leva frizione completa	LCF
Adjustable full clutch lever - Leva frizione completa regolabile	LCFR
EVO lever protection (without adaptor) - Protezione leva EVO (senza adattatore)	LPRR2_BK
Lever protection (without adaptor) - Protezione leva (senza adattatore)	LPRR_B_BK
Carbon lever protection (without adaptor) - Protezione leva in carbonio (senza adattatore)	LPLITE1_R
Tank cap (black) - Tappo serbatoio (nero)	FC220_BK
Swingarms spools - Supporti cavalletto	SCS8_BK
Swingarms spools "racing" - Supporti cavalletto "racing"	SCR8_BK





DESCRIPTION - DESCRIZIONE

CODE - CODICE

Rearset - Pedane	TH09
Engine protections - Protezioni motore	CP074
Brake lever - Leva freno	LB200
Brake lever with remote adjuster - Leva freno con registro a sx	RALB200
Brake lever with Racing remote adjuster - Leva freno con registro Racing a sx	RALB200R
Clutch lever - Leva frizione	LC080
Full clutch lever - Leva frizione completa	LCF
Adjustable full clutch lever - Leva frizione completa regolabile	LCFR
Levers kit - Kit leve	KL390
EVO lever protection (without adaptor) - Protezione leva EVO (senza adattatore)	LPRR2_BK
Lever protection (without adaptor) - Protezione leva (senza adattatore)	LPRR_B_BK
Carbon lever protection (without adaptor) - Protezione leva in carbonio (senza adattatore)	LPLITE1_R
Oil cap - Tappo olio	T009_BK
10 ml Oil tank - Serbatoio olio 10 ml	VS10P_BK
Tank cap - Tappo serbatoio	FC220_BK
Swingarms spools - Supporti cavalletto	SCS8_BK
Swingarms spools "racing" - Supporti cavalletto "racing"	SCR8_BK



DESCRIPTION - DESCRIZIONE

CODE - CODICE

Rearset - Pedane	TH09
Engine protections - Protezioni motore	CP074
Brake lever - Leva freno	LB210
Brake lever with remote adjuster - Leva freno con registro a sx	RALB210
Brake lever with Racing remote adjuster - Leva freno con registro Racing a sx	RALB210R
Clutch lever - Leva frizione	LC230
Full clutch lever - Leva frizione completa	LCF
Adjustable full clutch lever - Leva frizione completa regolabile	LCFR
Levers kit - Kit leve	KL360
EVO lever protection (without adaptor) - Protezione leva EVO (senza adattatore)	LPRR2_BK
Lever protection (without adaptor) - Protezione leva (senza adattatore)	LPRR_B_BK
Carbon lever protection (without adaptor) - Protezione leva in carbonio (senza adattatore)	LPLITE1_R
Oil cap - Tappo olio	T009_BK
10 ml Oil tank - Serbatoio olio 10 ml	VS10P_BK
Tank cap (black) - Tappo serbatoio (nero)	FC220_BK
Swingarms spools - Supporti cavalletto	SCS8_BK
Swingarms spools "racing" - Supporti cavalletto "racing"	SCR8_BK



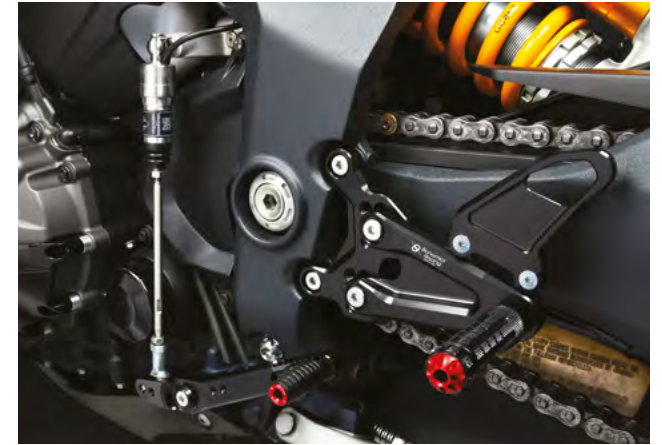

DESCRIPTION - DESCRIZIONE

CODE - CODICE

Rearset - Pedane	TH08
Engine protections - Protezioni motore	CP119
Brake lever - Leva freno	LB210
Brake lever with remote adjuster - Leva freno con registro a sx	RALB210
Brake lever with Racing remote adjuster - Leva freno con registro Racing a sx	RALB210R
Clutch lever - Leva frizione	LC230
Full clutch lever - Leva frizione completa	LCF
Adjustable full clutch lever - Leva frizione completa regolabile	LCFR
Levers kit - Kit leve	KL360
EVO lever protection (without adaptor) - Protezione leva EVO (senza adattatore)	LPRR2_BK
Lever protection (without adaptor) - Protezione leva (senza adattatore)	LPRR_B_BK
Carbon lever protection (without adaptor) - Protezione leva in carbonio (senza adattatore)	LPLITE1_R
Oil cap - Tappo olio	T009_BK
10 ml Oil tank - Serbatoio olio 10 ml	VS10P_BK

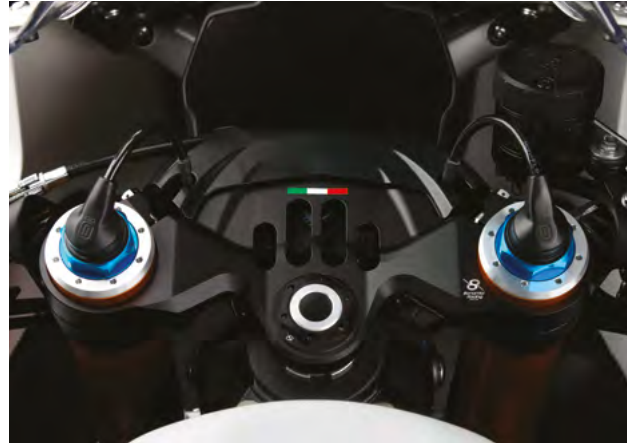

DESCRIPTION - DESCRIZIONE

CODE - CODICE

Rearset - Pedane	TH07
Engine protections - Protezioni motore	CP119
Top triple clamp - Piastra di sterzo superiore*	PST1
Brake lever - Leva freno	LB210
Brake lever with remote adjuster - Leva freno con registro a sx	RALB210
Brake lever with Racing remote adjuster - Leva freno con registro Racing a sx	RALB210R
Clutch lever - Leva frizione	LC230
Full clutch lever - Leva frizione completa	LCF
Adjustable full clutch lever - Leva frizione completa regolabile	LCFR
Levers kit - Kit leve	KL360
EVO lever protection (without adaptor) - Protezione leva EVO (senza adattatore)	LPRR2_BK
Lever protection (without adaptor) - Protezione leva (senza adattatore)	LPRR_B_BK
Carbon lever protection (without adaptor) - Protezione leva in carbonio (senza adattatore)	LPLITE1_R
Oil cap - Tappo olio	T009_BK
10 ml Oil tank - Serbatoio olio 10 ml	VS10P_BK



(*) Equipped with Bonamici Racing Nut, when mounting it is recommended to apply a light layer of grease.

(*) Dotata del dado Bonamici Racing, si consiglia al momento del montaggio del dado di applicare un leggero strato di grasso

Some items can be purchased in colors other than standard black - Alcuni articoli possono essere acquistati in colori diversi dal nero standard



DESCRIPTION - DESCRIZIONE

CODE - CODICE

Rearset - Pedane	Y011
Rearset with bracket for OEM Akrapovic exhaust Pedana con staffa per scarico Akrapovic OEM	Y011A
Bracket for OEM Akrapovic exhaust - Staffa per scarico Akrapovic OEM	SS_007A
Engine protections - Protezioni motore	CP047
Unlifted handlebars - Semimanubri bassi	SM50B
Top triple clamp "Street" - Piastra di sterzo superiore "Street"	PSY1
Top triple clamp "Race" - Piastra di sterzo superiore "Race"	PSY1R
Dashboard protection - Protezione strumentazione	DCP04
Brake lever - Leva freno	LB101
Clutch lever - Leva frizione	LC010
Full clutch lever - Leva frizione completa	LCF
Adjustable full clutch lever - Leva frizione completa regolabile	LCFR
Levers kit - Kit leve	KL231
EVO lever protection (without adaptor) - Protezione leva EVO (senza adattatore)	LPRR2_BK
Lever protection (without adaptor) - Protezione leva (senza adattatore)	LPRR_B_BK
Carbon lever protection (without adaptor) - Protezione leva in carbonio (senza adattatore)	LPLITE1_R
Tank cap (black) - Tappo serbatoio (nero)	FC110_BK
Oil cap - Tappo olio	T007_BK
10 ml Oil tank - Serbatoio olio 10 ml	VS10P_BK
Chain adjuster - Tendicatena	CHAD03_BK
Swingarms spools - Supporti cavalletto	SCS6_BK
Swingarms spools "racing" - Supporti cavalletto "racing"	SCR6_BK



DESCRIPTION - DESCRIZIONE

CODE - CODICE

Rearset - Pedane	Y011
Rearset with bracket for OEM Akrapovic exhaust (2020/2022) Pedana con staffa per scarico Akrapovic OEM (2020/2022)	Y011A
Bracket for OEM Akrapovic exhaust - Staffa per scarico Akrapovic OEM	SS_007A
Engine protections - Protezioni motore	CP047
Unlifted handlebars - Semimanubri bassi	SM50B
Top triple clamp "Street" - Piastra di sterzo superiore "Street"	PSY1
Top triple clamp "Race" - Piastra di sterzo superiore "Race"	PSY1R
Dashboard protection - Protezione strumentazione	DCP04
Brake lever - Leva freno	LB101
Clutch lever - Leva frizione	LC010
Full clutch lever - Leva frizione completa	LCF
Adjustable full clutch lever - Leva frizione completa regolabile	LCFR
Levers kit - Kit leve	KL231
EVO lever protection (without adaptor) - Protezione leva EVO (senza adattatore)	LPRR2_BK
Lever protection (without adaptor) - Protezione leva (senza adattatore)	LPRR_B_BK
Carbon lever protection (without adaptor) - Protezione leva in carbonio (senza adattatore)	LPLITE1_R
Tank cap (black) - Tappo serbatoio (nero)	FC110_BK
Oil cap - Tappo olio	T007_BK
10 ml Oil tank - Serbatoio olio 10 ml	VS10P_BK
Chain adjuster - Tendicatena	CHAD11_BK
Swingarms spools - Supporti cavalletto	SCS6_BK
Swingarms spools "racing" - Supporti cavalletto "racing"	SCR6_BK



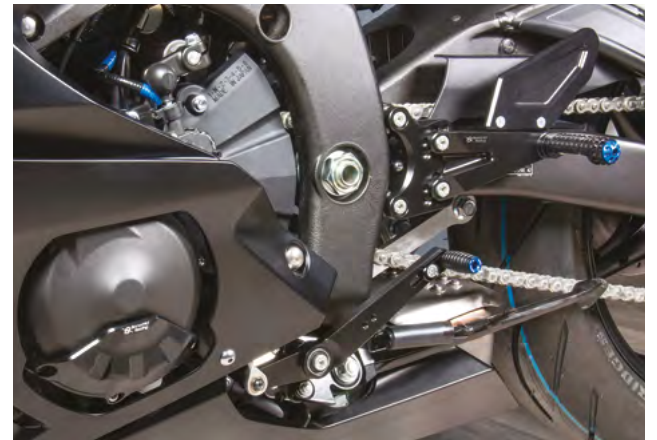

DESCRIPTION - DESCRIZIONE

CODE - CODICE

Rearset - Pedane	Y013
Engine protections - Protezioni motore	CP025
Unlifted handlebars - Semimanubri bassi	SM50B
Lifted handlebars - Semimanubri rialzati	SM50
Top triple clamp "Street" - Piastra di sterzo superiore "Street"	PSY2
Top triple clamp "Race" - Piastra di sterzo superiore "Race"	PSY2R
Brake lever - Leva freno	LB100
Brake lever with remote adjuster - Leva freno con registro a sx	RALB100
Clutch lever - Leva frizione	LC010
Full clutch lever - Leva frizione completa	LCF
Adjustable full clutch lever - Leva frizione completa regolabile	LCFR
Levers kit - Kit leve	KL230
EVO lever protection (without adaptor) - Protezione leva EVO (senza adattatore)	LPRR2_BK
Lever protection (without adaptor) - Protezione leva (senza adattatore)	LPRR_B_BK
Carbon lever protection (without adaptor) - Protezione leva in carbonio (senza adattatore)	LPLITE1_R
Tank cap (black) - Tappo serbatoio (nero)	FC110_BK
Oil cap - Tappo olio	T007_BK
10 ml Oil tank - Serbatoio olio 10 ml	VS10P_BK
Chain adjuster - Tendicatena	CHAD07_BK
Swingarms spools - Supporti cavalletto	SCS6_BK
Swingarms spools "racing" - Supporti cavalletto "racing"	SCR6_BK
Gear spacer support - Supporto distanziale cambio	DC_037B

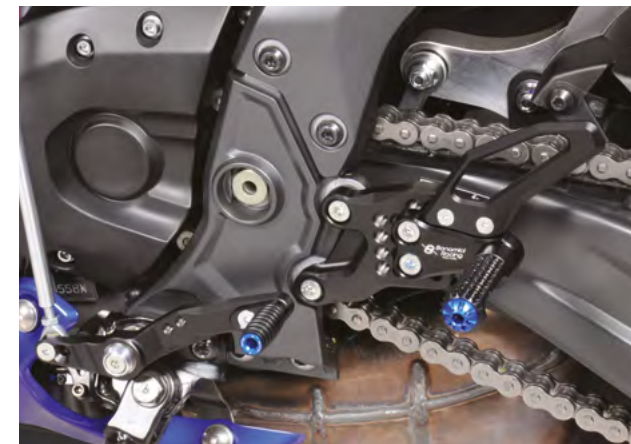
**DESCRIPTION - DESCRIZIONE****CODE - CODICE**

Rearsets - Pedane	Y015
Unlifted handlebars - Semimanubri bassi	SM50B
Top triple clamp "Street" - Piastra di sterzo superiore "Street"	PSY3
Top triple clamp "Race" - Piastra di sterzo superiore "Race"	PSY3R
Top triple clamp Nut - Dado piastra di sterzo superiore	DD3
Dashboard protection - Protezione strumentazione	DCP16
Brake lever - Leva freno It can only be mounted on Bonamici Racing handlebars Code SM50B Può essere montata solo sui semimanubri Bonamici Racing Codice SM50B	LB220
Brake lever with remote adjuster - Leva freno con registro a sx	RALB220
Clutch lever - Leva frizione	LC010
Full clutch lever - Leva frizione completa	LCF
Adjustable full clutch lever - Leva frizione completa regolabile	LCFR
Levers kit - Kit leve	KL340
EVO lever protection (without adaptor) - Protezione leva EVO (senza adattatore)	LPRR2_BK
Lever protection (without adaptor) - Protezione leva (senza adattatore)	LPRR_B_BK
Carbon lever protection (without adaptor) - Protezione leva in carbonio (senza adattatore)	LPLITE1_R
Tank cap (black) - Tappo serbatoio (nero)	FC110_BK
Oil cap - Tappo olio	T007_BK
10 ml Oil tank - Serbatoio olio 10 ml	VS10P_BK
Swingarms spools - Supporti cavalletto	SCS6_BK
Swingarms spools "racing" - Supporti cavalletto "racing"	SCR6_BK





DESCRIPTION - DESCRIZIONE

CODE - CODICE

Rearset - Pedane		Y012
Rearset - Pedane*	raised +40 mm compared to Y012	Y012_40
Lifted handlebars (*15/18) - Semimanubri rialzati (*15/18)		SM41
Lifted handlebars (*19/ >) - Semimanubri rialzati (*19/ >)		SM47
Brake lever - Leva freno		LB170
Brake lever with remote adjuster - Leva freno con registro a sx		RALB170
Clutch lever - Leva frizione		LC150
Full clutch lever - Leva frizione completa		LCF
Adjustable full clutch lever - Leva frizione completa regolabile		LCFR
Levers kit - Kit leve		KL250
EVO lever protection (without adaptor) - Protezione leva EVO (senza adattatore)		LPRR2_BK
Lever protection (without adaptor) - Protezione leva (senza adattatore)		LPRR_B_BK
Carbon lever protection (without adaptor) - Protezione leva in carbonio (senza adattatore)		LPLITE1_R
Tank cap (black) - Tappo serbatoio (nero)		FC110_BK
Oil cap - Tappo olio		T007_BK
10 ml Oil tank - Serbatoio olio 10 ml		VS10P_BK
Swingarms spools - Supporti cavalletto		SCS6_BK
Swingarms spools "racing" - Supporti cavalletto "racing"		SCR6_BK

(*) The brake hose needs to be replaced - (*) È necessario sostituire il tubo freno

**DESCRIPTION - DESCRIZIONE**

DESCRIPTION - DESCRIZIONE	CODE - CODICE
Rearset - Pedane	Y016
Brake lever - Leva freno (2021-2023 models)	LB101
Clutch lever - Leva frizione (2021-2023 models)	LC010
Full clutch lever - Leva frizione completa	LCF
Adjustable full clutch lever - Leva frizione completa regolabile	LCFR
Levers kit - Kit leve (2021-2023 models)	KL231
EVO lever protection (without adaptor) - Protezione leva EVO (senza adattatore)	LPRR2_BK
Lever protection (without adaptor) - Protezione leva (senza adattatore)	LPRR_B_BK
Carbon lever protection (without adaptor) - Protezione leva in carbonio (senza adattatore)	LPLITE1_R
Tank cap (black) - Tappo serbatoio (nero)	FC110_BK
Oil cap - Tappo olio	T008_BK
Swingarms spools - Supporti cavalletto	SCS6_BK
Swingarms spools "racing" - Supporti cavalletto "racing"	SCR6_BK



SALES CONDITIONS

All the prices on the brochures are expressed in euro and not comprehensive of VAT tax.

2D®, Aprilia®, BMW®, Braking®, Brembo®, Discacciati®, Ducati®, Honda®, I2M®, Kawasaki®, Ktm®, MV Agusta®, PT®, Suzuki®, Triumph®, Yamaha® are registered trademarks and used for reference.

All Bonamici Racing products are made for agonistic use only.

All Bonamici Racing products are 100% made in Italy, employing high quality materials.

Bonamici Racing reserves the right to change prices and sales conditions at any moment without further notice for commercial and technical purposes. This brochure provides information of general nature and does not represent a contractual binding.

All photos, images and informations displayed in this brochure are property of Bonamici Racing, total or partial reproduction is strictly forbidden.

All Bonamici Racing products have 2 years warranty.

WARNING:

Open the packaging with caution; installation must be operated by specialized personnel with appropriate equipment and follow any instructions contained in the packaging.

Before use make sure that all screws are tightened with care. Employ "Loctite" adhesive. Do not modify or tamper the parts for any reason. If you have difficulties in assembly, contact the company

CONDIZIONI GENERALI DI VENDITA

I prezzi dei prodotti presenti in catalogo sono in euro e non includono l'IVA.

2D®, Aprilia®, BMW®, Braking®, Brembo®, Discacciati®, Ducati®, Honda®, I2M®, Kawasaki®, Ktm®, MV Agusta®, PT®, Suzuki®, Triumph®, Yamaha® sono marchi di proprietà delle rispettive case ed usati solo a titolo descrittivo.

Tutti i prodotti Bonamici Racing sono da usare esclusivamente per le competizioni.

Tutti i prodotti Bonamici Racing sono realizzati al 100% in Italia con materiali di alta qualità.

Bonamici Racing si riserva il diritto di apportare modifiche costruttive ed ai prezzi dei prodotti presenti nel catalogo in qualunque momento e senza alcun preavviso. Questo catalogo fornisce informazioni di carattere generale e non costituisce documento contrattuale.

Tutte le foto, le immagini e le informazioni presenti in questo catalogo sono proprietà della Bonamici Racing, è vietato l'uso improprio.

Tutti i prodotti Bonamici Racing hanno 2 anni di garanzia.

AVVERTENZE:

Aprire la confezione con cura, il montaggio deve essere eseguito da personale specializzato con attrezzatura adeguata e seguire le eventuali istruzioni contenute nella confezione.

Prima dell'uso assicurarsi che tutte le viti siano tirate con cura. Usare la Loctite.

Non modificare o manomettere per alcun motivo le parti. Se si riscontrano difficoltà nel montaggio contattare l'azienda.



Bonamici Racing S.r.l.

info@bonamiciracing.it
sales@bonamiciracing.it
www.bonamiciracing.it
tel. +39.0744.71.91.32

Headquarters - Sede operativa:

Strada Flaminia sn. civ.
Z.I. Molette di Otricoli
05030 Otricoli (TR)
Italy

Registered office - Sede amministrativa:

Vocabolo Verzieri , snc
02046 Magliano Sabina (RI)
Italy



www.bonamiciracing.it