

2023

HIGH QUALITY MOTORCYCLE PARTS





Dominique Aegerter rider of GRT Yamaha WorldSBK team on his Yamaha YZF R1

TECHNICAL PARTNERSHIP

Moto3 World Championship



WorldSBK - WorldSSP



BSB British Superbike



Endurance World Championship



MotoAmerica



Tuono Cup



National Trophy CIV



We are the official supplier of important teams within the world of international competitions. Race tracks are the best test bench for our high performance components.

Siamo fornitori ufficiali di importanti Team nel mondo delle competizioni internazionali. I circuiti di gara sono il miglior banco prova per i nostri componenti ad alte prestazioni.

INDEX - INDICE

ABOUT US - CHI SIAMO	7
REARSETS - PEDANE	8
ENGINE PROTECTIONS - PROTEZIONI MOTORE	32
DASHBOARD PROTECTIONS - PROTEZIONI STRUMENTAZIONE	48
TOP TRIPLE CLAMP - PIASTRE DI STERZO SUPERIORI	52
LEVERS - LEVE	56
FULL CLUTCH LEVER - LEVE FRIZIONE COMPLETE	68
BRAKE LEVER WITH REMOTE ADJUSTER - LEVE FRENO CON REGISTRO REMOTO	70
REMOTE ADJUSTER - REGISTRO REMOTO	71
LEVER PROTECTIONS - PROTEZIONE LEVE	74
HANDLEBARS - SEMIMANUBRI	78
CHAIN ADJUSTER - TENDICATENA	82
OIL TANK 8 ml - SERBATOIO OLIO 8 ml	84
SWING ARMS SPOOL - SUPPORTI CAVALLETTO	85
MIRROR BLOCKS - TAPPI SPECCHIETTO	86
OIL CAPS - TAPPI OLIO	87
TANK CAPS - TAPPO SERBATOIO	88
MERCHANDISING	90
MODELS - MODELLI	94

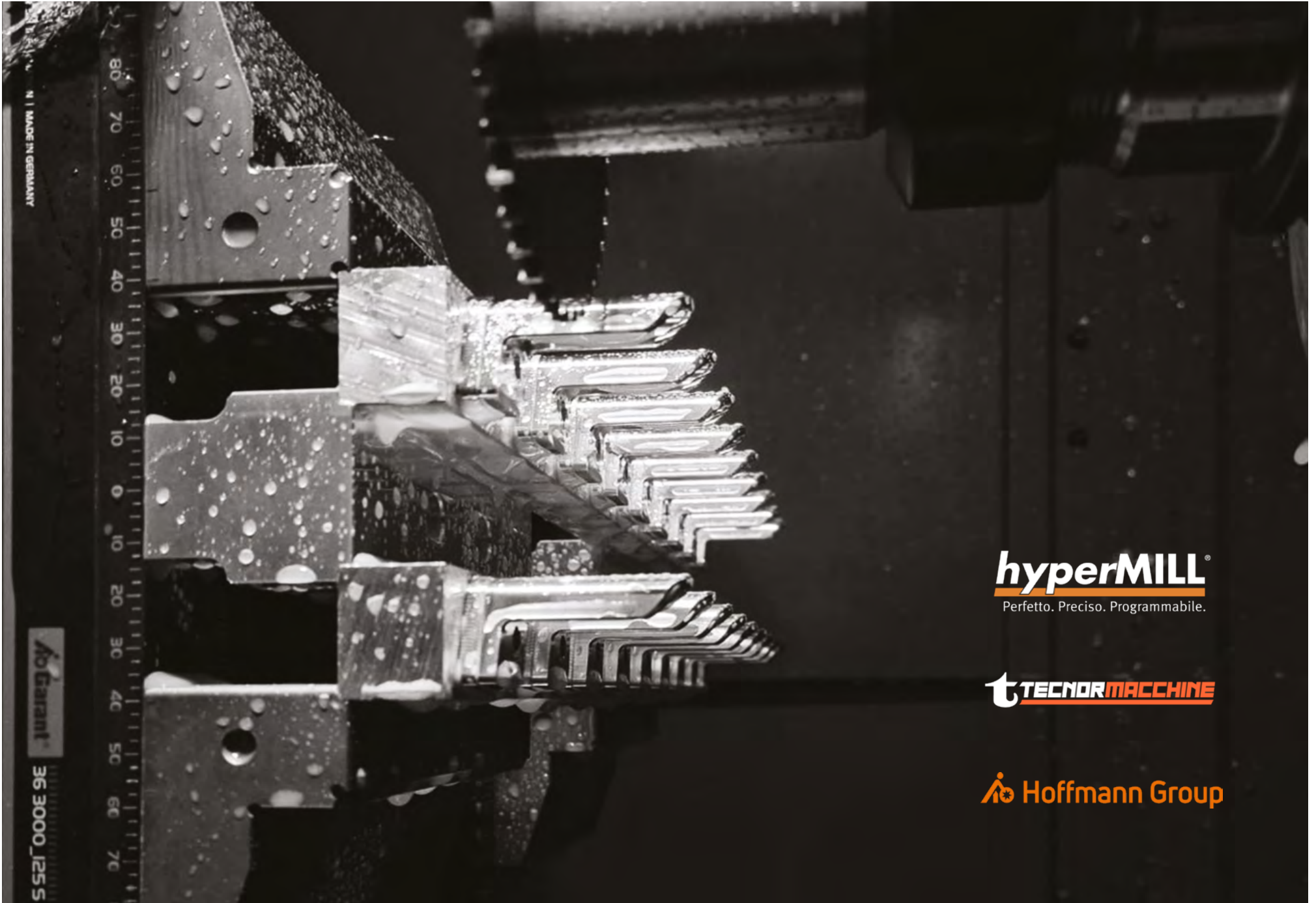

N | MADE IN GERMANY

AvGarant

S 521 000E 9E 36 3000 125 S

80 70 60 50 40 30 20 10 0 10 20 30 40 50 60 70

hyperMILL®
Perfetto. Preciso. Programmabile.

t TECNORMACCHINE

Hoffmann Group



Design Progettazione

Every single detail of our products is the result of an accurate engineering design process, we develop the racing components that weigh no one gram more than necessary. The beauty of the lightness became tangible throughout the design, perspective and lines have been drawn to push over the performance.

Anche il più piccolo dettaglio dei nostri prodotti è il risultato di un accurato processo di progettazione, sviluppiamo componenti da competizione che non pesano un grammo più del necessario. La bellezza della leggerezza è resa tangibile attraverso il design, prospettiva e linee sono tracciate per andare oltre le prestazioni.



Production Realizzazione

We use the best technologies to produce the racing accessories with maximum care possible. By making a constant quality-oriented investments, by using of CNC machines and the best titanium, aluminum and steel alloys, we make high technology accessories to obtain the best performance during the race competitions.

Usiamo le migliori tecnologie per produrre accessori per moto in maniera accurata. Attraverso investimenti sulla qualità, l'uso di macchine a controllo numerico e le migliori leghe di titanio, alluminio e acciaio, produciamo accessori altamente performanti, in modo da ottenere il massimo delle prestazioni durante le competizioni motociclistiche.



Assistance Assistenza

We are ever ready to assist our customers and to provide them with the best solutions to optimize their mode to run the bike. We are able to develop new racing accessories and improve our products based on the reciprocal feedback. Our aftersales staff can solve any problems with maximum care and efficiency possible.

Siamo sempre pronti ad aiutare i nostri clienti per dargli le migliori soluzioni in grado di ottimizzare il loro modo di correre in moto. Siamo in grado di sviluppare nuovi accessori da corsa e migliorare i nostri prodotti attraverso il feedback costante tra noi ed i nostri clienti. Il nostro personale post-vendita è in grado di risolvere tutti i problemi con la massima cura ed efficienza possibile.



Tradition Tradizione

The Italian culture leads us to appreciate the beauty that is transmitted in all our products. We produce our accessories in Italy with the respect of Italian tradition. The history teaches us to create new items using the ingredients that brought Italy a fame in the field of race competitions.

La cultura italiana ci ha dato il senso del bello che noi trasmettiamo a tutti i nostri prodotti. Produciamo i nostri accessori in Italia con il rispetto della tradizione italiana, la storia ci insegna a fare nuovi oggetti, con tutti gli ingredienti che hanno reso l'Italia famosa nel mondo delle competizioni.

REARSETS - PEDANE

REARSETS TECHNICAL FEATURES

- High performance aluminum
- Double ball bearings
- Racing foot pegs with high grip
- Wide adjustment of the foot pegs position
- Hard anodic oxidation treatment
- Shift lever adjustable
- Break point of the foot pegs
- Non-slip rubber tip

REARSETS CARATTERISTICHE TECNICHE

- Alluminio ad alte prestazioni
- Doppi cuscinetti a sfera
- Poggiapiedi racing ad alto grip
- Regolazione della posizione del poggiapiedi
- Trattamento di ossidazione anodica dura
- Leva del cambio regolabile
- Punto di rottura del poggiapiedi
- Punta in gomma antiscivolo

BRAKE LEVER - LEVA FRENO

GEAR LEVER - LEVA CAMBIO

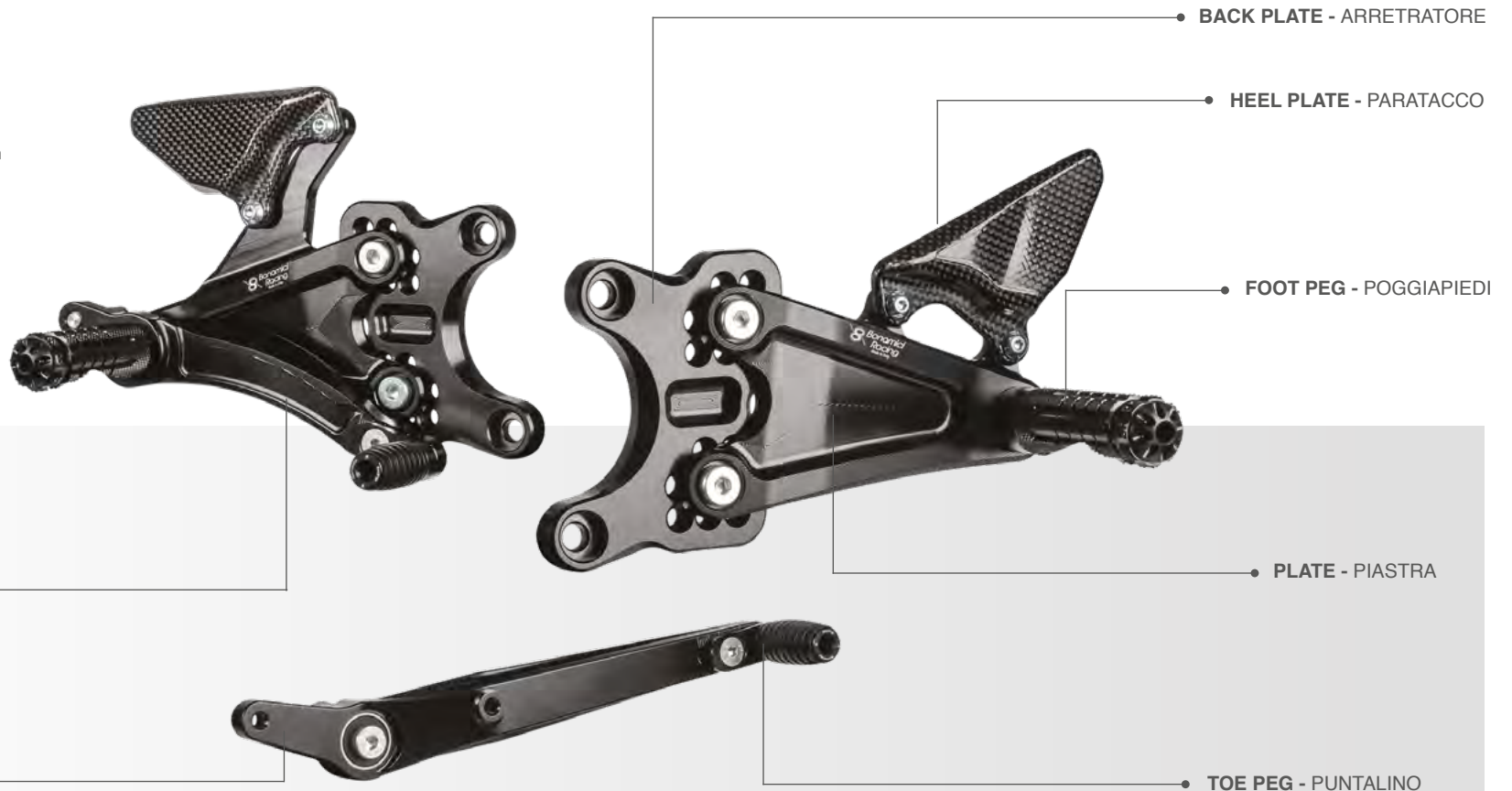

Bonamici Racing designs and manufactures rearsets for most of the models of sport-bikes on the market since 1994.

Made from billet high-strength aluminum alloys with CNC technology, Bonamici Racing rearsets have many peculiarities, among them there is the use of ball bearings to completely eliminate friction on the levers, spring for the assisted return of the rear brake lever and the possibility of adjustment in different positions.

All the rearsets in our catalog are anodized in black to have greater mechanical resistance and greater resistance to the chemical agents, in addition we have the possibility of customizing the platforms in many ways.

Bonamici Racing progetta e realizza pedane poggiapiedi per la maggior parte di modelli di moto sportive presenti sul mercato dal 1994.

Realizzate dal pieno in leghe di alluminio ad alta resistenza con tecnologia CNC, le pedane Bonamici Racing hanno molte peculiarità, tra queste vi è l'uso di cuscinetti a sfera per eliminare completamente gli attriti sui leveraggi, molla per il ritorno assistito della leva freno posteriore e la possibilità di regolazione in differenti posizioni.

Tutte le pedane presenti in catalogo sono anodizzate nel colore nero per avere una maggiore resistenza meccanica ed agli agenti chimici, inoltre c'è la possibilità di personalizzare le pedane in tanti modi.



NOTES - NOTE

A: without brake and gear levers, the original one to be used - senza leve cambio e freno, si utilizzano quelle originali
B: remove the sprocket protection - rimuovere il carter copripignone
C: remove the plastic protection from the exhaust - rimuovere la protezione in plastica sullo scarico
D: remove the lateral stand - rimuovere il cavalletto laterale
D1: remove the lateral stand (only for reverse shifting) - rimuovere il cavalletto laterale (solo per cambio rovesciato)
E: it is not possible to mount the passenger rearsets - non è possibile rimontare le pedane del passeggero
F: includes the gear selector - include il selettore cambio
G: includes the rear oil tank - include il serbatoio olio posteriore
H: includes the warm carbon protection - include il paracalore in carbonio
I: includes carbon heel plates - include i paratacchi in carbonio
L: it is not possible to mount the hydrostop - non è possibile montare l'hydrostop
M: it need to modify the original fairing - occorre modificare le carene originali

N: can use in normal shifting mode - può funzionare con il cambio normale
O: it need to change the rear brake tube - è necessario sostituire il tubo freno posteriore
P: it's possible to mount carbon heel plates accessories - è possibile montare i paratacchi in carbonio come accessorio
R: can use in reverse shifting mode - può funzionare con il cambio rovesciato
S: without brake lever, the original one to be used - senza leva del freno, si utilizza quella originale
T: it is not necessary to mount the hydrostop - non è necessario montare l'hydrostop
V: Includes folding foot pegs - Include poggia piedi chiudibili
W: it is possible to mount folding foot pegs without modifying the plate, see the table "folding foot pegs" on page 26 and page 27
 è possibile montare il poggia piedi chiudibile senza modificare la pedana, consultare la tabella "poggia piedi chiudibili" a pagina 26 e pagina 27

Please note: some models with and without ABS may need to replace the rear brake tubes
 Attenzione: per alcuni modelli con e senza ABS potrebbe essere necessario sostituire i tubi freni posteriori

APRILIA

MODEL - MODELLO	FROM - DAL	TO - AL	CODE - CODICE	NOTES - NOTE
RSV4 - Tuono V4	2009	2016	A003	N/R/F/P/W
RSV4 APRC - TUONO V4 APRC (street)	2011	2016	A004	N/P/W
RSV4 APRC - TUONO V4 APRC (race)	2011	2016	A004R	R/P/W
RSV4 - RSV4 RF - RSV4 Factory - Tuono V4 (street)	2017	>	A005S	N/P/W
RSV4 - RSV4 RF - RSV4 Factory - Tuono V4 (race)	2017	>	A005SR	R/P/W
RS 660 - Tuono 660	2020	>	A006	N/P/R/T/W



APRILIA RSV4 FACTORY
RSV4 RF - TUONO - cod. A005S

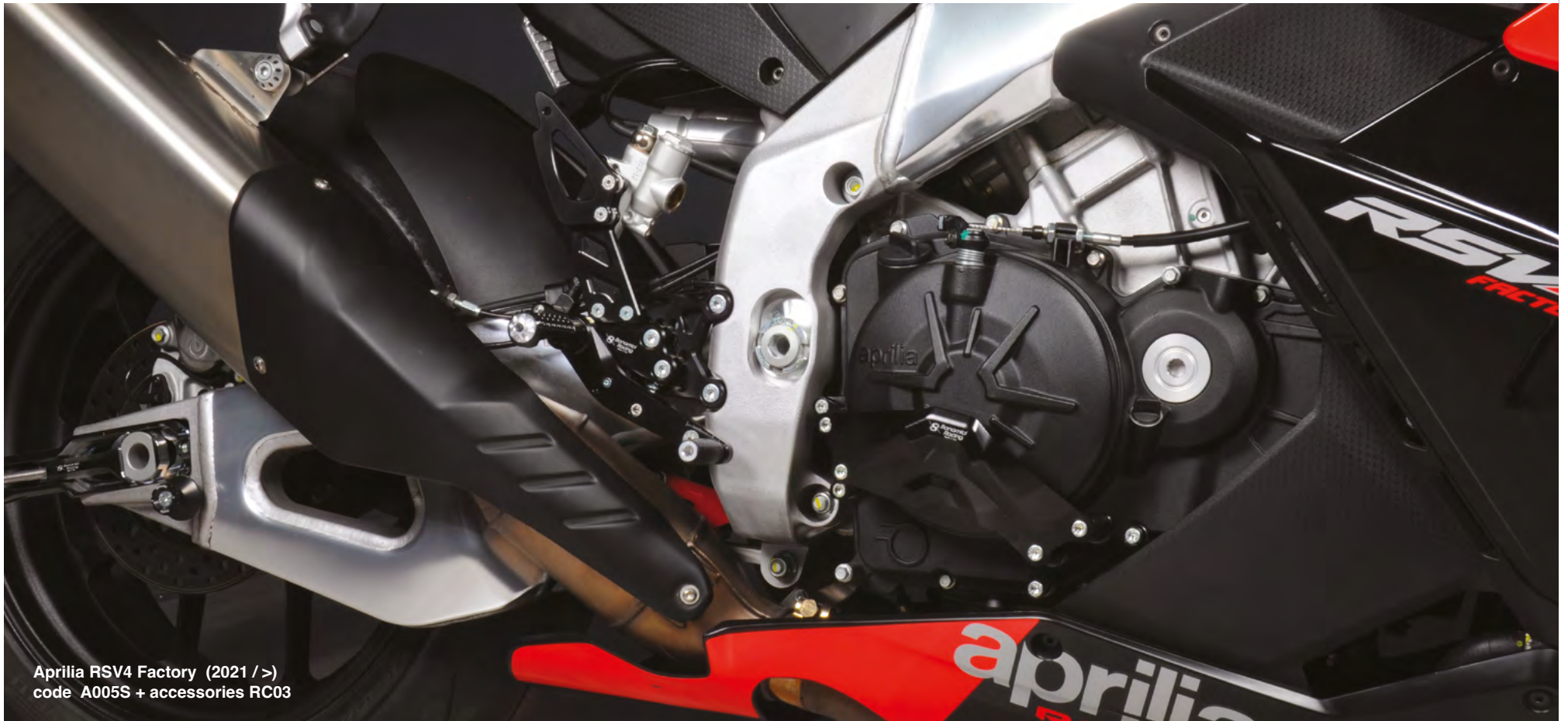

Aprilia RSV4 Factory (2021 / >)
code A005S + accessories RC03

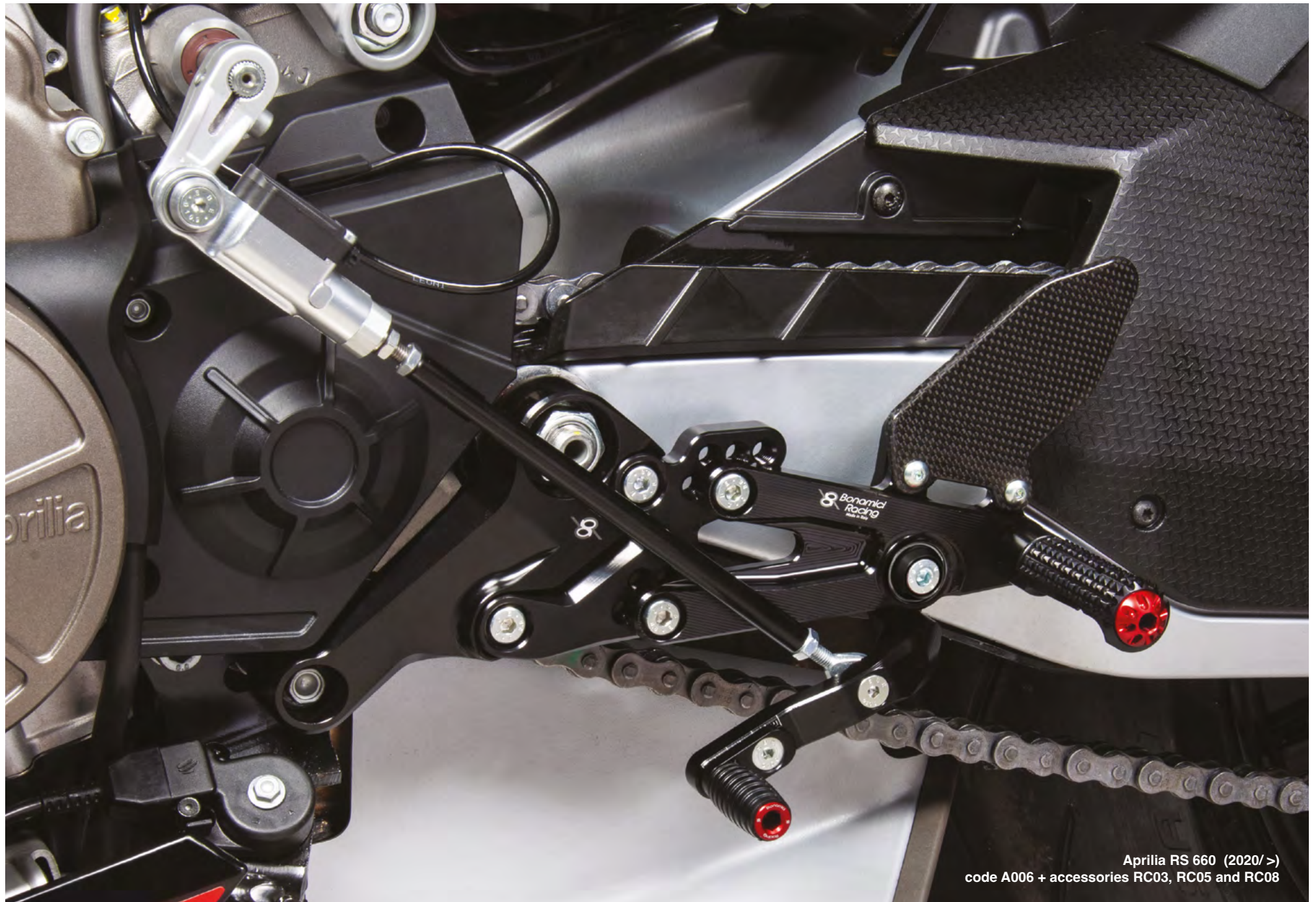

Aprilia RS 660 (2020/ >)
code A006 + accessories RC03, RC05 and RC08

FOOT PEG INSERTS AND BRAKE SIDE TOE PEG FOR APRILIA TUAREG 660
INSERTI POGGIAPIEDI E PUNTALINO LATO FRENO APRILIA TUAREG 660

The pair of aluminum inserts was created in order to improve performance and obtain the maximum in terms of grip in daily use and especially off-road.

Made from high-strength aluminum alloys using numerical control machines (CNC) with 3D technology. Easy to assemble, the inserts fit neatly inside the teeth of the OEM foot pegs replacing the existing rubber ones, same thing for the brake side toe-peg which replaces the original.

La coppia di inserti in alluminio nasce per migliorare le prestazioni e ottenere il massimo in termini di grip nell'uso quotidiano e soprattutto in fuoristrada.

Realizzato in leghe di alluminio ad alta resistenza utilizzando macchine a controllo numerico (CNC) con tecnologia 3D. Il nuovo kit è facile da montare, gli inserti si adattano perfettamente all'interno dei denti delle pedane OEM sostituendo quelli in gomma esistenti, stessa cosa per il puntalino lato freno che sostituisce l'originale.

MODEL - MODELLO	YEAR - ANNO	DESCRIPTION - DESCRIZIONE	CODE - CODICE
Tuareg 660	2021 >	full kit 3pcs. - kit completo 3pz.	A007

SPARE PARTS

DESCRIPTION - DESCRIZIONE	CODE - CODICE
Foot peg Insert (LH/RH) - Inserto poggia piedi (Sx/Dx)	A007_A
Brake side Toe peg - Puntalino lato freno	PU_007

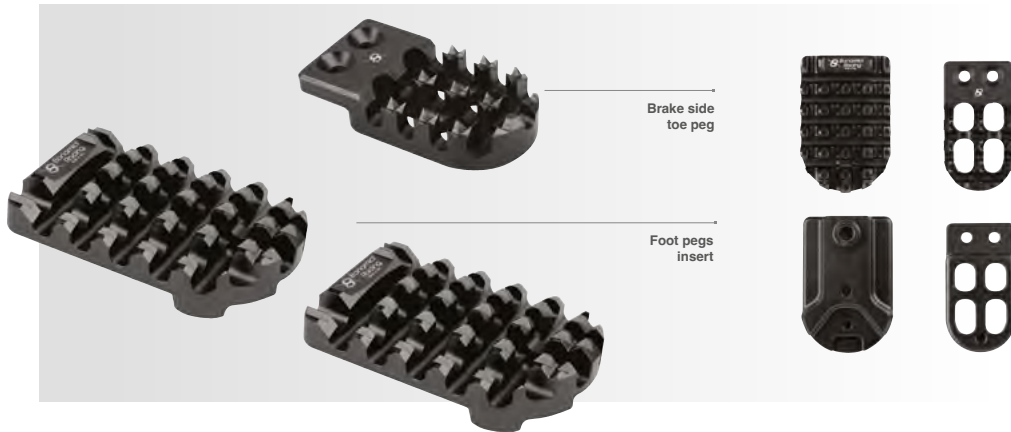

Available colours - Colori disponibili



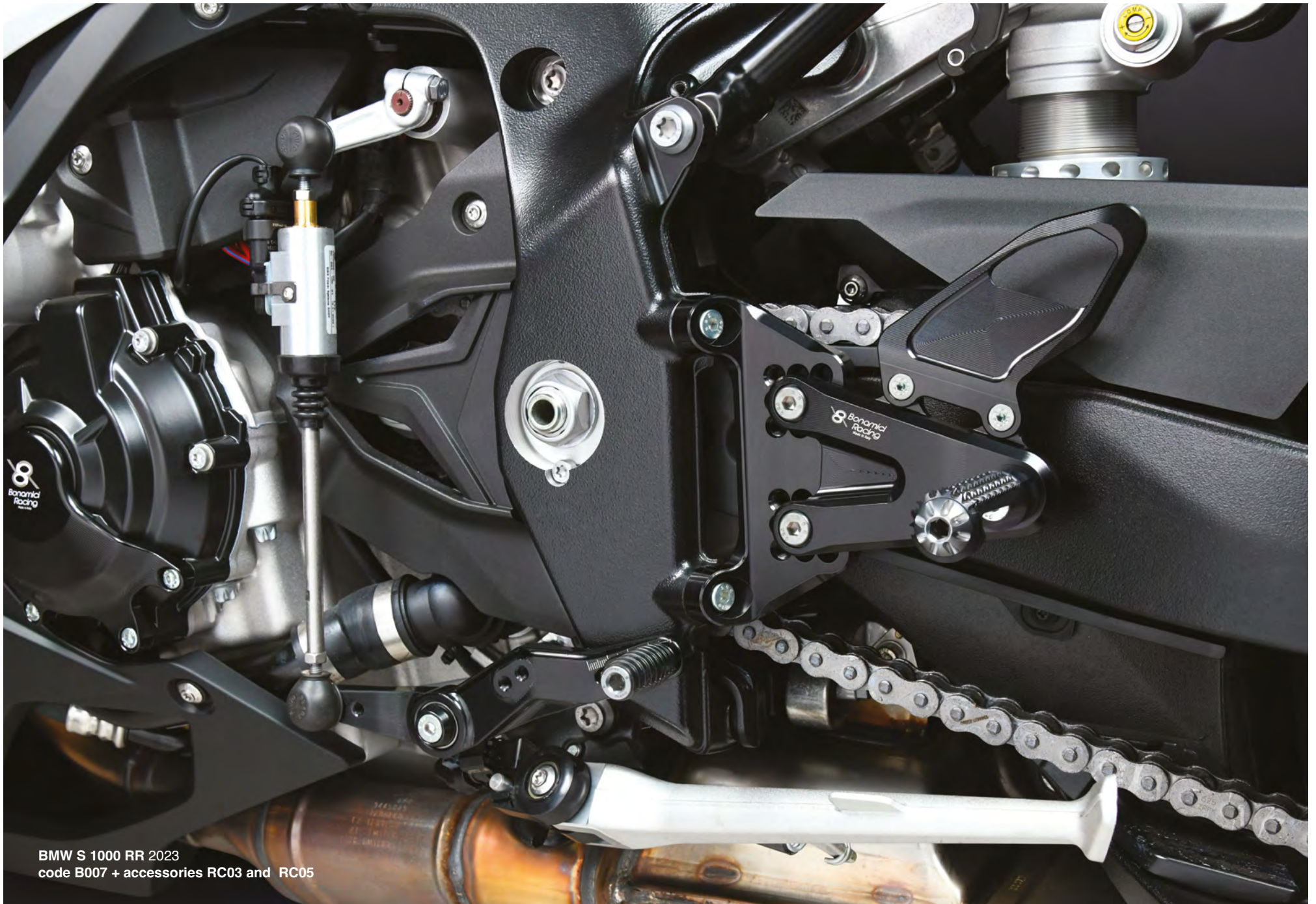

BMW S 1000 RR 2023
code B007 + accessories RC03 and RC05

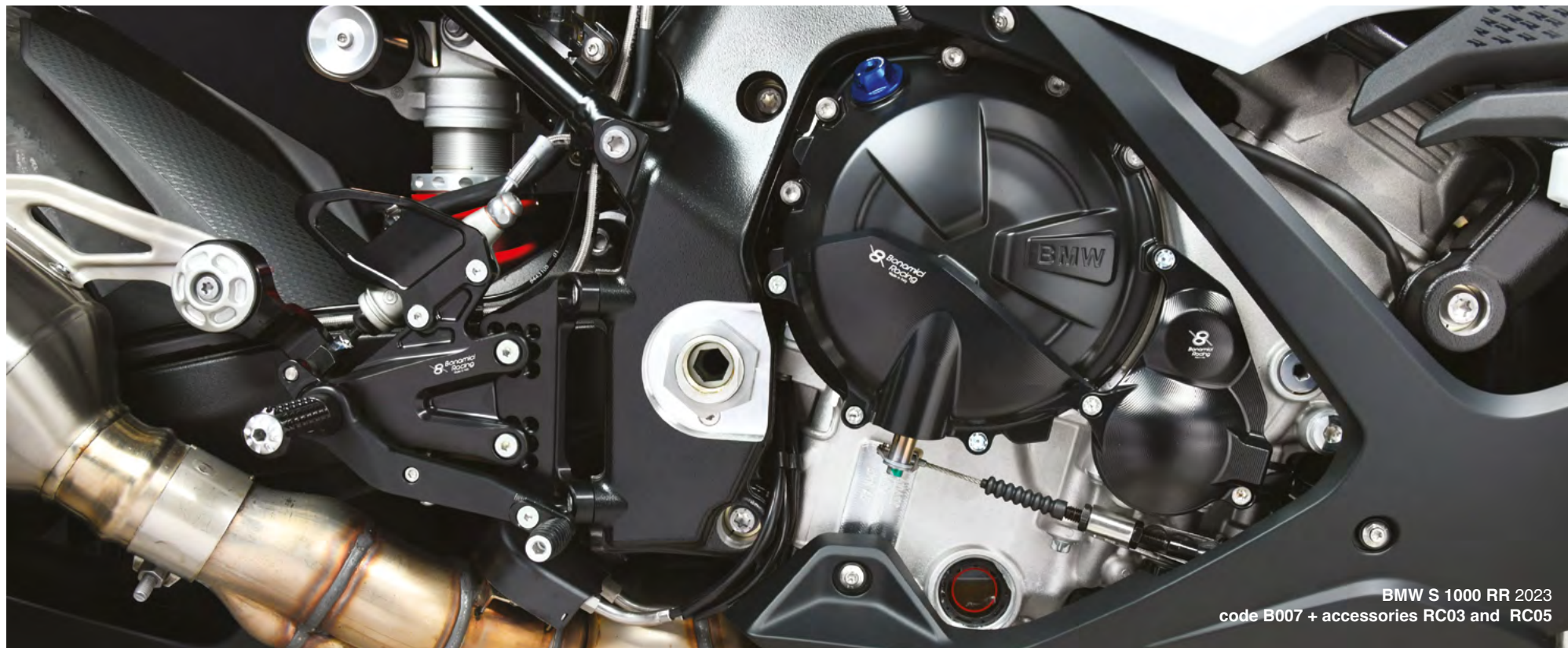

BMW S 1000 RR 2023
code B007 + accessories RC03 and RC05



● BMW S 1000 RR - cod. B007

BMW

MODEL - MODELLO	FROM - DAL	TO - AL	CODE - CODICE	NOTES - NOTE
S 1000 RR - HP4 (street)	2008	2014	B001	I/N/W
S 1000 RR - HP4 (race)	2008	2014	B001R	R/B/M/P/W
S 1000 RR	2015	2018	B005	N/R/P/W
S 1000 RR - M 1000 RR	2019	>	B007	N/R/P/T/W
S 1000 R (street)	2012	2016	B001	I/N/W
S 1000 R (race)	2012	2016	B001R	R/B/P/W
S 1000 R	2017	2020	B006	N/R/P/W
S 1000 R	2021	>	B008	N/R/P/T/W
S 1000 XR	2020	>	B009	N/P/T/V



Ducati Panigale V4
code DV4 + accessories RC03

DUCATI

MODEL - MODELLO	FROM - DAL	TO - AL	CODE - CODICE	NOTES - NOTE
Scrambler 800 single seater - monoposto	2015	>	DSCR1	N
748 / 916 / 996 / 998	1994	2004	D916	N/R/T/W
749 / 999	2002	2006	D999	N/R/T/W
848 / 1098 / 1198	2007	2011	D1098	N/R/T/W
899 / 959 / 1199 / 1299 Panigale	2012	2018	DV2	N/R/W
Panigale V4 / V4S / V4R	2018	>	DV4	N/R/P/W
Panigale V2	2020	>	DV2	N/R/W
Streetfighter	2009	2015	DSTR	N/R/H/T/W
Streetfighter V2	2022	>	DSTR3	N/R/W
Streetfighter V4	2020	>	DSTR2	N/R/P/W



DUCATI 899 / 1098 / 1198 - cod. D1098



DUCATI PANIGALE V2 - cod. DV2



DUCATI PANIGALE V4 - cod. DV4



Ducati Streetfighter V2 (2022/ >)
code DSTR3 + accessories RC03, RC05

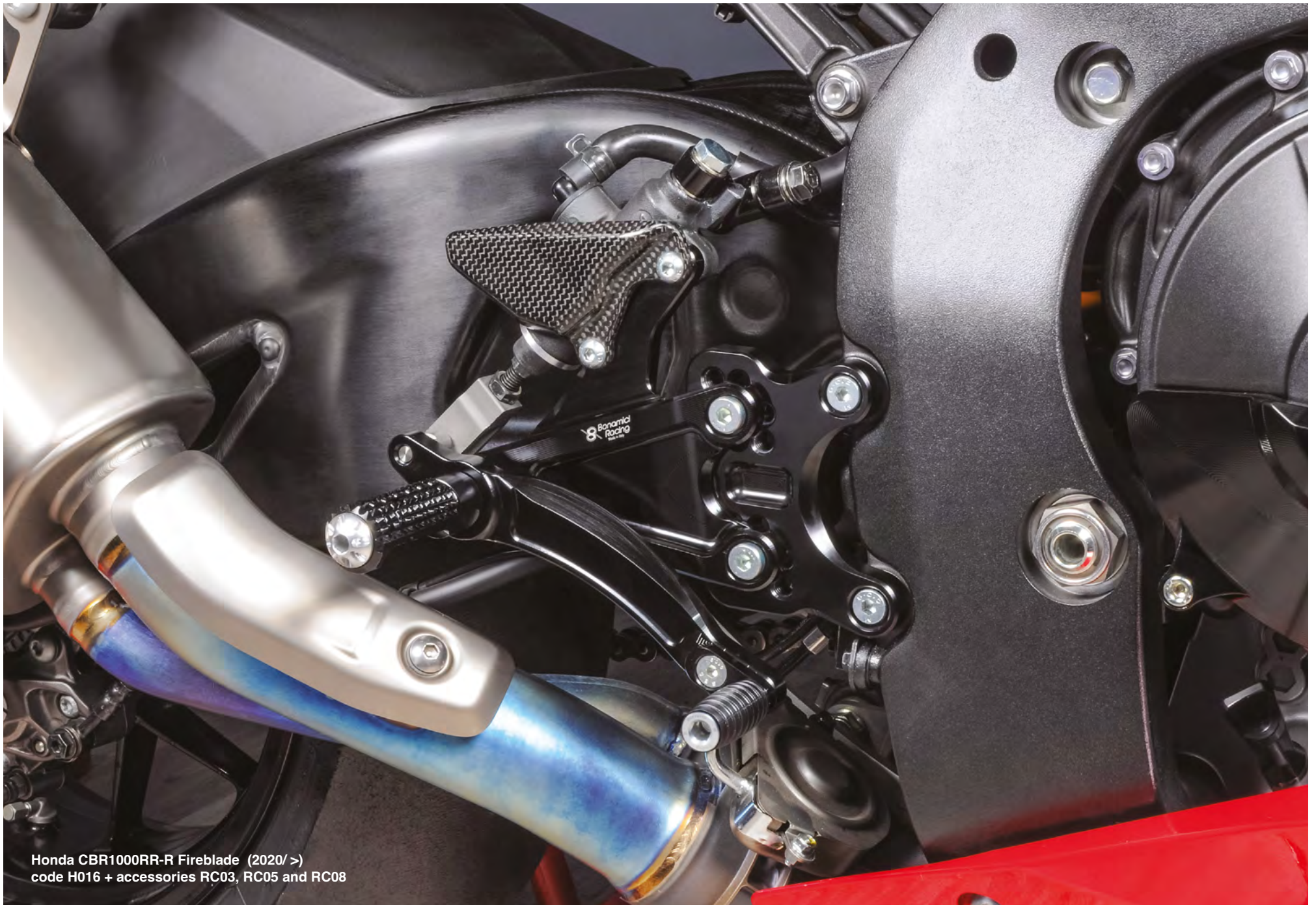

Honda CBR1000RR-R Fireblade (2020/ >)
code H016 + accessories RC03, RC05 and RC08



● HONDA CBR 650 R/CB 650 R/F - cod. H012



● HONDA CBR 600 RR (race) - cod. H006



● HONDA CBR1000RR-R FIREBLADE - cod. H015

HONDA

MODEL - MODELLO	FROM - DAL	TO - AL	CODE - CODICE	NOTES - NOTE
CBR 600 RR (street)	2003	2006	H001	N/C/P/W
CBR 600 RR (race)	2003	2006	H003	R/C/D/P/W
CBR 600 RR (street)	2007	>	H005	N/C/P/O/W
CBR 600 RR (race)	2007	>	H006	R/C/D/P/O/W
CBR 1000 RR (street)	2004	2007	H002	N/C/P/W
CBR 1000 RR (race)	2004	2007	H004	R/C/F/M/P/W
CBR 1000 RR (street)	2008	2016	H008	N/F/P/W
CBR 1000 RR (race)	2008	2016	H009	R/P/W
CBR 1000 RR Fireblade	2017	2019	H013	F/N/R/P/W
CBR 1000 RR Fireblade SP/SP2	2017	2019	H014	F/N/R/P/W
CBR 1000 RR-R "Racing"	2020	>	H015	N/R/O/P/W
CBR 1000 RR-R "Standard"	2020	>	H016	N/R/P/W
CBR 650 R/CB 650 R/F	2014	>	H012	N/R/W
VTR 1000 SP1/SP2 *	2000	2006	H007	F/N/R/P/W

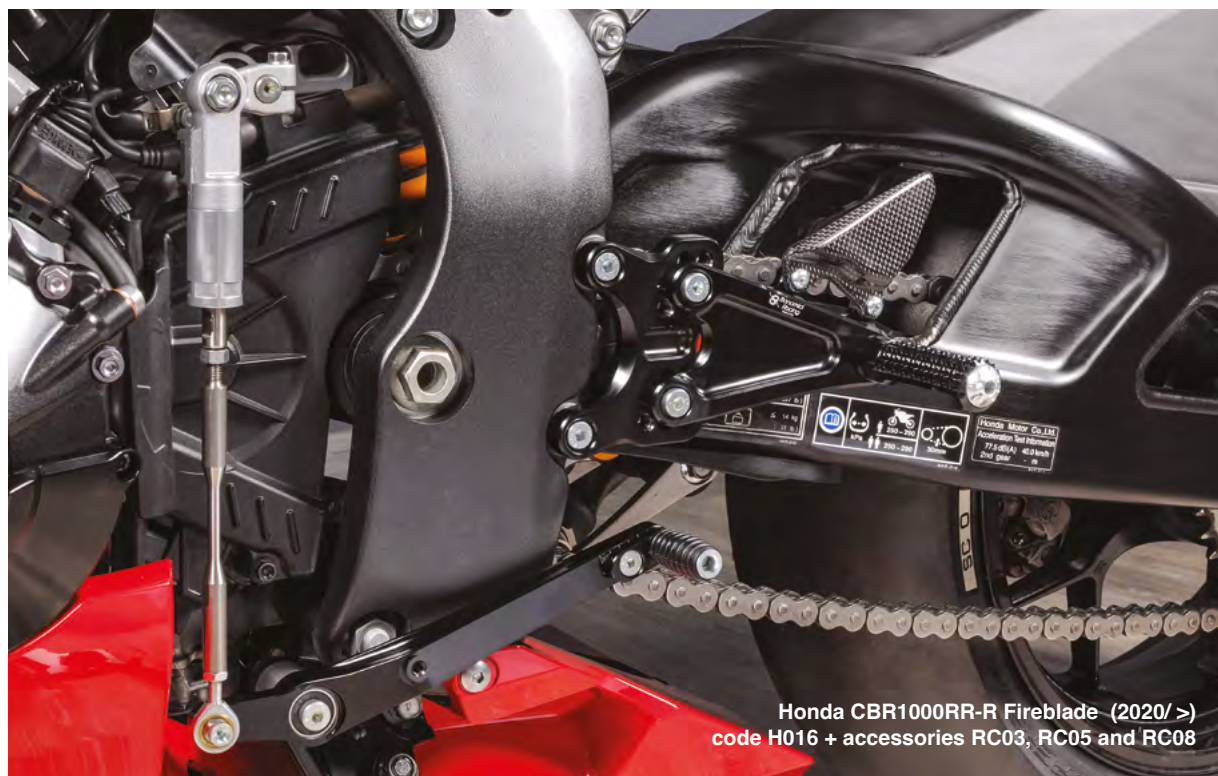

Honda CBR1000RR-R Fireblade (2020/ >)
code H016 + accessories RC03, RC05 and RC08

KAWASAKI

MODEL - MODELLO	FROM - DAL	TO - AL	CODE - CODICE	NOTES - NOTE
Ninja 250/400	2018	>	K019	N/R/F/P/W
ZX-6R *	2003	2004	K003	N/R/P/W
ZX-6R	2005	2006	K005	N/R/P/W
ZX-6R	2007	2008	K006	N/R/P/W
ZX-6R	2009	2017	K010	N/R/P/W
ZX-6R	2019	>	K020	N/P/O/W
ZX-10R *	2004	2005	K001	N/R/P/W
ZX-10R	2006	2007	K002	N/R/P/W
ZX-10R	2008	2010	K008	N/R/P/W
ZX-10R	2011	2015	K012	N/R/F/P/W
ZX-10R	2016	2020	K015	N/F/P/W
ZX-10R	2021	>	K021	N/R/F/T/W
Z 650/Ninja 650	2017	2019	K018	N/R/F/P/W
Z 750 *	2007	2012	K009	N/R/P/W
Z 900	2017	2019	K017	N/R/F/P/W
Z 1000	2007	2009	K009	N/R/P/W
Z 1000	2010	2018	K011	N/P/W



KAWASAKI ZX-10R - cod. K021

KTM

MODEL - MODELLO	FROM - DAL	TO - AL	CODE - CODICE	NOTES - NOTE
Duke 125 / 200 / 250 / 390	2014	2020	KT01	N/R/P/W
RC125 / 200 / 250 / 390	2014	2020	KT01	N/R/P/W
790 / 890 Duke / 890 Duke R	2018	>	KT04	N/R/P/T/W
1290 Superduke / R / GT	2013	2019	KT03	N/R/P/W
1290 Superduke R	2020	>	KT05	N/R/T/W



790 / 890 Duke / 890 Duke R - cod. KT04

* Available only on specific request - * Disponibili solo su specifica richiesta



1290 Superduke R (2020->) - cod. KT05

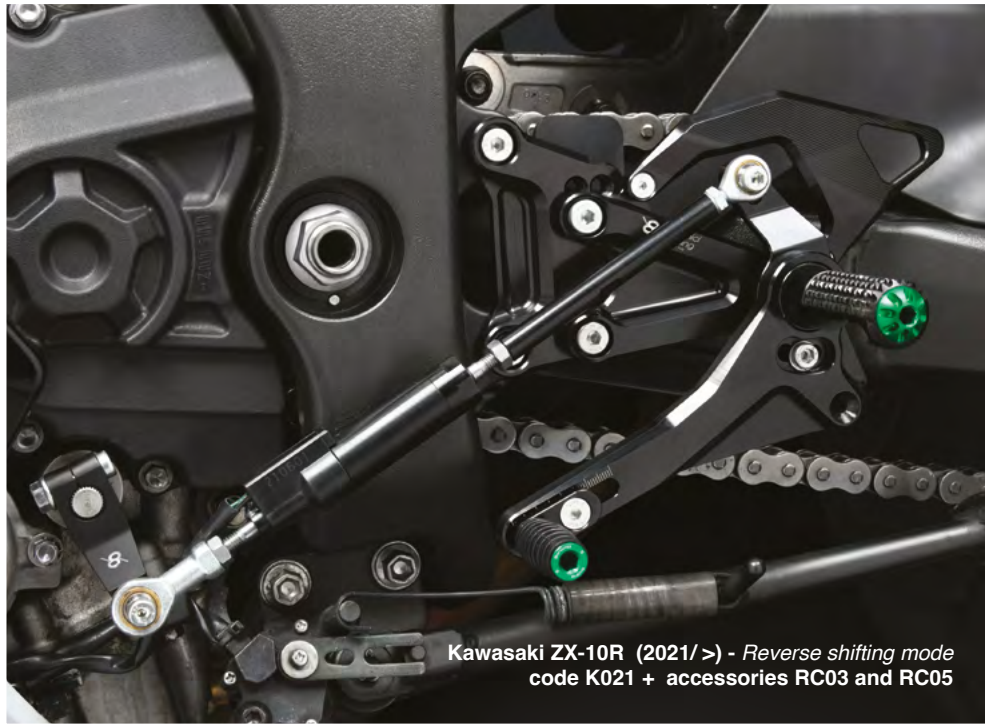

Kawasaki ZX-10R (2021/ >) - Reverse shifting mode
code K021 + accessories RC03 and RC05

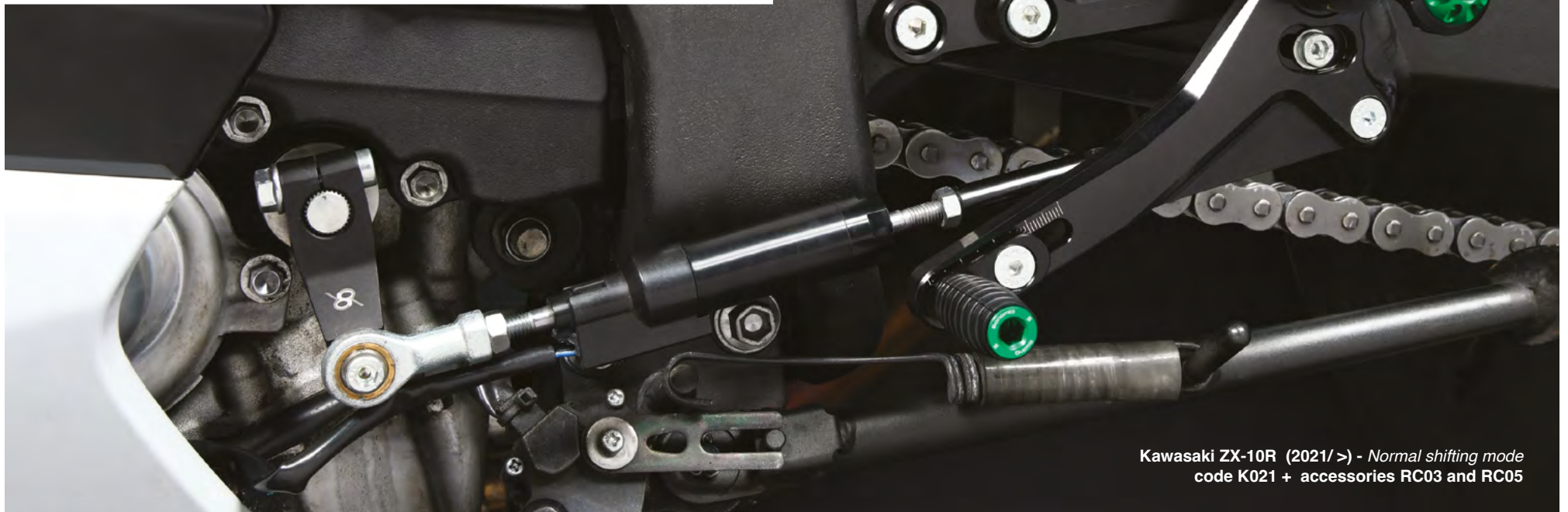

Kawasaki ZX-10R (2021/ >) - Normal shifting mode
code K021 + accessories RC03 and RC05

Triumph Speed Triple 1200 RR (2022/>)
code TH07 + accessories RC03 and RC05

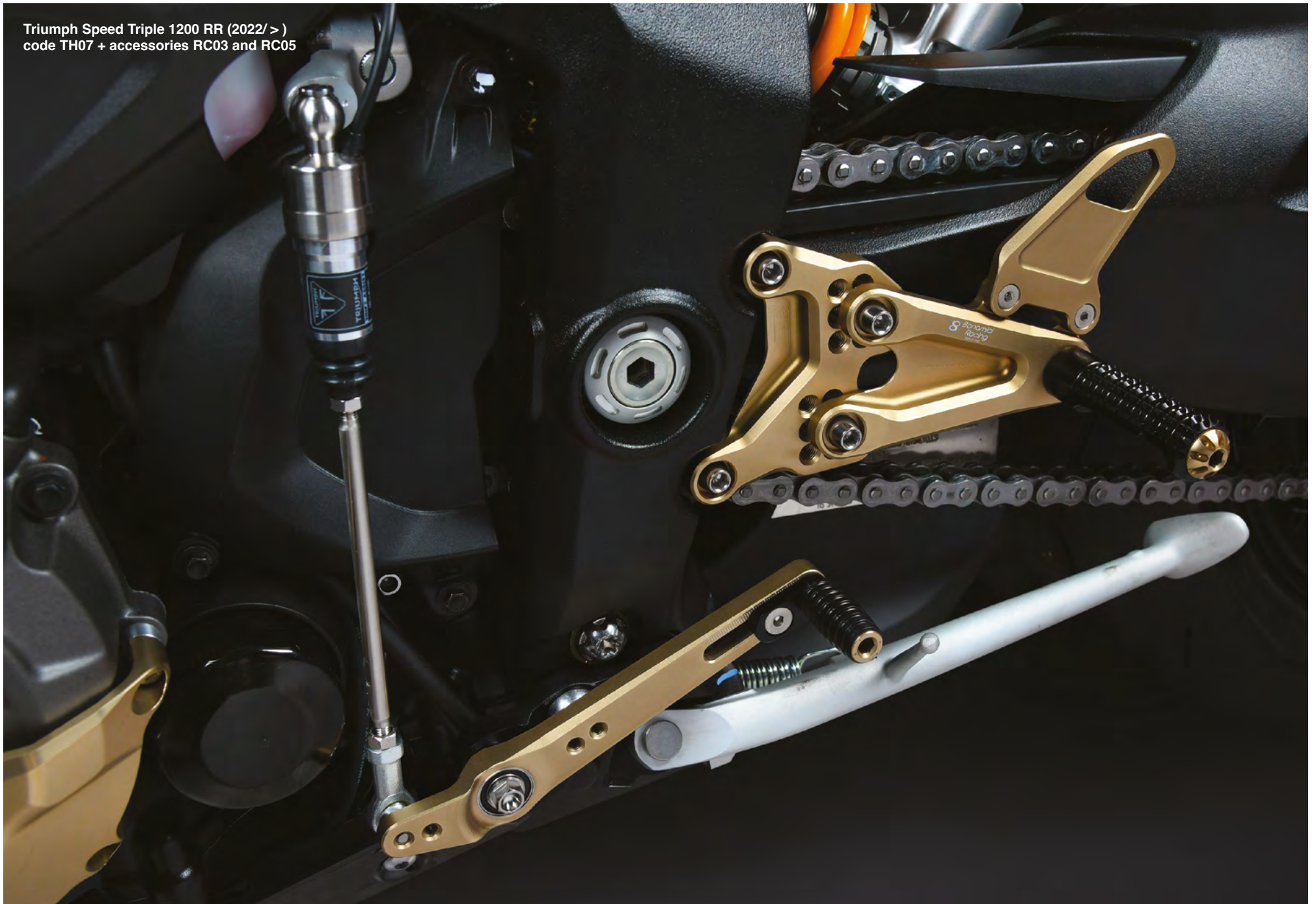



● SUZUKI GSX-R 1000 - cod. S011



● TRIUMPH SPEED TRIPLE 1200 RR - cod. TH07



● YAMAHA YZF R6 - cod. Y013

SUZUKI

MODEL - MODELLO	FROM - DAL	TO - AL	CODE - CODICE	NOTES - NOTE
GSX-R 600 / 750	2006	2010	S004	N/R/P/W
GSX-R 600 / 750	2011	2017	S008	N/R/P/W
GSX-R 1000 *	2005	2006	S001	N/R/P/W
GSX-R 1000	2007	2008	S006	N/R/P/W
GSX-R 1000	2009	2016	S007	N/R/P/W
GSX-R 1000	2017	>	S011	N/R/P/W
GSR 750 / GSX-S 750	2011	2020	S009	N/R/P/W

TRIUMPH

MODEL - MODELLO	FROM - DAL	TO - AL	CODE - CODICE	NOTES - NOTE
Daytona/Street Triple 675 without Quickshifter - senza QS	2006	2012	TH01	N/R/P/W
Daytona 675 without Quickshifter - senza QS	2013	2017	TH03	F/N/R/W
Daytona 675 Quickshifter (street)	2013	2017	TH03	F/N/W
Daytona 675 Quickshifter (race)	2013	2017	TH03R	F/R/W
Street Triple 675	2013	2016	TH04	F/N/R/W
Street Triple S/R/RS 765	2017	2022	TH06	F/N/R/L/P/W
NEW Street Triple 765 R/RS/Moto 2	2023	>	TH09	F/N/P/R/T/W
Speed Triple 1050 (street)	2011	2020	TH05	F/N/P/T/D/W
Speed Triple 1200 RS	2021	>	TH08	N/R/T/W
Speed Triple 1200 RR	2022	>	TH07	N/R/T/W

YAMAHA

MODEL - MODELLO	FROM - DAL	TO - AL	CODE - CODICE	NOTES - NOTE
YZF R3 / R25	2015	>	Y012	F/N/R/P/W
YZF R6 *	1999	2002	Y003	N/P/W
YZF R6 *	2003	2005	Y004	N/F/P/W
YZF R6	2006	2016	Y005	N/R/P/W
YZF R6	2017	>	Y013	N/R/W
YZF R1 *	1998	2003	Y001	N/R/P/W
YZF R1 (street) *	2004	2006	Y002	N/F/P/W
YZF R1 (race) *	2004	2006	Y002R	R/B/P/W
YZF R1 (street)	2007	2008	Y006	N/C/F/P/W
YZF R1 (race)	2007	2008	Y006R	R/C/P/W
YZF R1	2009	2014	Y007	N/R/P/W
YZF R1/R1M	2015	>	Y011	N/R/P/W
YZF R7	2021	>	Y015	N/R/T/W

MODEL - MODELLO	FROM - DAL	TO - AL	CODE - CODICE	NOTES - NOTE
MT-07/FZ07	2014	2020	Y010	N/R/P/W
MT-09 / FZ09 / XSR 900 / Tracer without Quickshifter - senza QS	2013	2020	Y008	N/R/W
NEW MT-09	2021	>	Y016	F/N/R/T/W
MT-10 / FZ10	2016	2020	Y014	N/R/P/W

WARNING
ATTENZIONE

- Before use, make sure that all screws are tightened with care. Use light strength thread-locker.
- The assistance of professional staff is necessary for all the parts which require installation.
- All Bonamici Racing products are made for racing use only (not for street use).
- After any kind of impact, it is obligatory to replace the affected parts.
- It is obligatory to check the tightened of the screws after every ride session.
- Prima dell'uso, assicurarsi che tutte le viti siano serrate con cura. Usa un frenafili.
- Per tutte le parti che necessitano di installazione è necessaria l'assistenza di personale qualificato.
- Tutti i prodotti Bonamici Racing sono realizzati esclusivamente per uso agonistico (non per uso stradale).
- Dopo ogni tipo di urto è obbligatorio sostituire le parti interessate.
- È obbligatorio controllare il serraggio delle viti dopo ogni sessione di guida.



YAMAHA YZF R1/R1M - cod. Y011

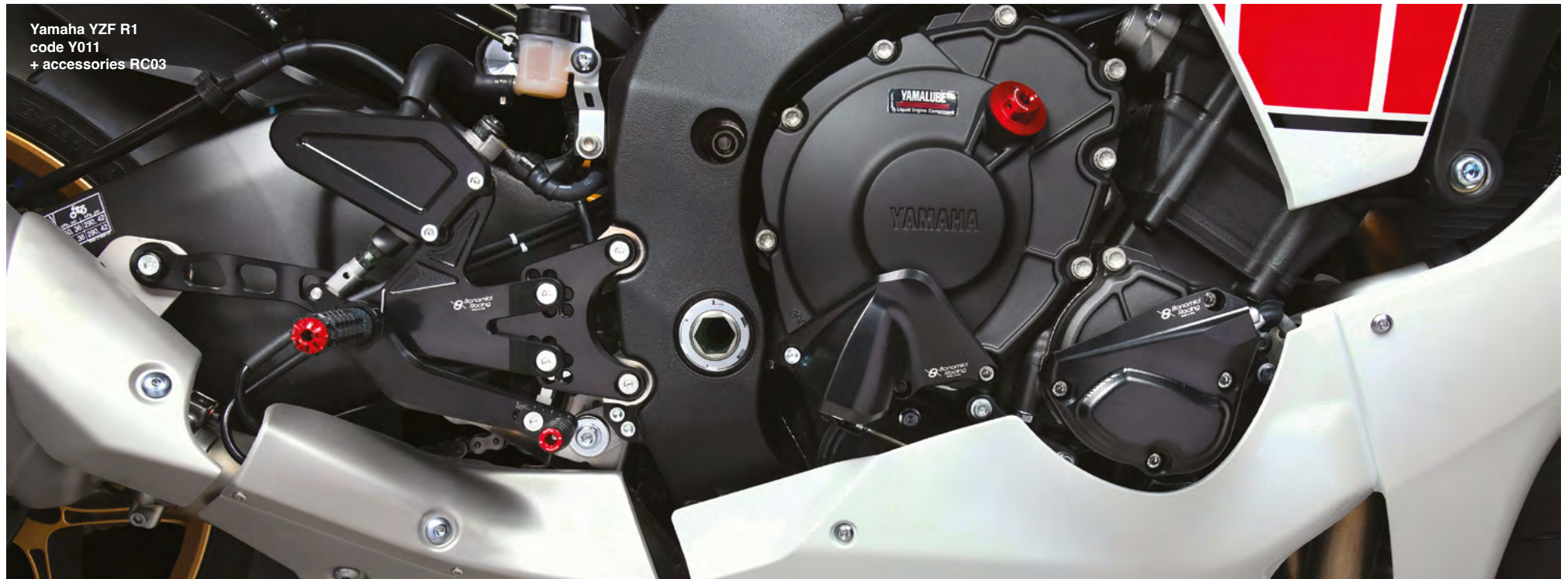

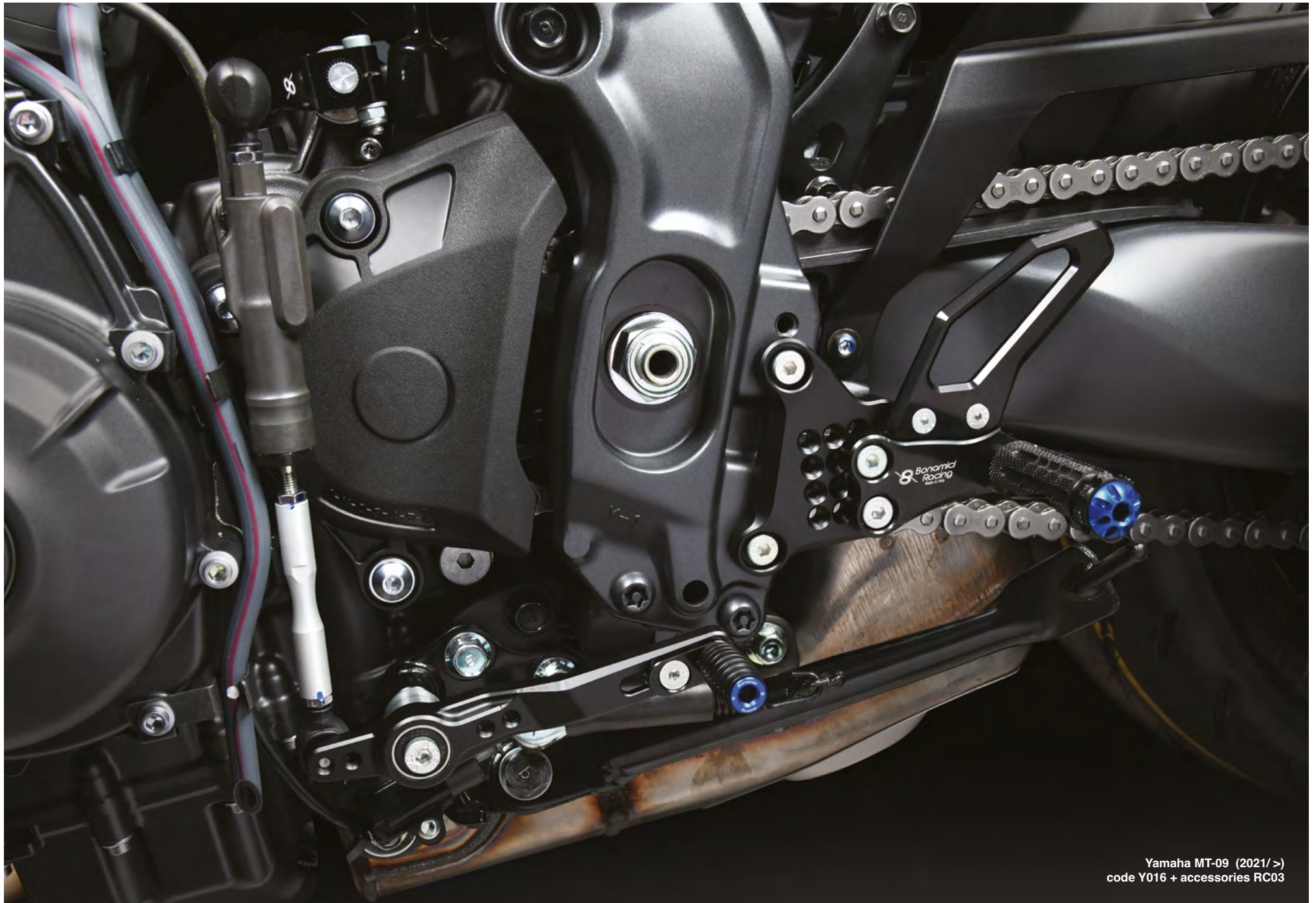

Yamaha MT-09 (2021/ >)
code Y016 + accessories RC03

REARSETS ACCESSORIES - ACCESSORI PEDANE

The full range of Bonamici Racing rearsets is supplied in the "Standard" version with black color, aluminum heelplates, fixed foot pegs and toe pegs. At the time of purchase it is possible to request the rearsets in different colors and with laser engraving, the rest of the accessories can all be purchased separately. Pay attention to the "notes" on the rearsets page.

L'intera gamma pedane Bonamici Racing è fornita nella versione "Standard" con colore nero, paratacchi in alluminio, poggiaiedi e puntalini fissi. Al momento dell'acquisto è possibile richiedere la pedana in diversi colori e con incisione laser, il resto degli accessori sono acquistabili tutti separatamente. Fare attenzione alle "note" nella pagina pedane.

DESCRIPTION - DESCRIZIONE	CODE - CODICE	NOTES - NOTE
Pair of racing foot pegs - Coppia di poggiaiedi racing	RC05	-
NEW Pair of folding foot pegs - Coppia di poggiaiedi chiudibili	KPC	6
Pair of standard folding toe pegs - Coppia di puntalini chiudibili standard	RC02	-
Pair of knurled folding toe pegs - Coppia di puntalini chiudibili godronati	RC02G	-
Pair of striped folding toe pegs - Coppia di puntalini chiudibili rigati	RC02R	-
Laser engravings (one pair) - Incisioni laser (coppia)	KK04	1
Pair of carbon heel plates - Coppia di paratacchi in carbonio	RC08	3
Hydrostop M10 x 1 - Interruttore stop idraulico M10 x 1	HD100	4
Hydrostop M10 x 1,25 - Interruttore stop idraulico M10 x 1,25	HD125	4
Wired hydrostop for Ducati - Interruttore stop cablato per Ducati	HDC01	-
Wired hydrostop for Ducati Streetfighter V4/V2 - Interruttore stop cablato per Ducati Streetfighter V4/V2	HDC02	-
Spring kit rearsets - Pacco molla pedane	RC06	2
Pairs of colored aluminum caps and toe pegs - Coppie di tappi e puntalini in alluminio colorati	RC03	-
Extra colour for rearsets - Colore extra per pedane	KK07	1 - 5
Aluminium stand for rearsets - Espositore pedane in Alluminio	EX01	-

NOTES - NOTE

- Available only by purchasing a new rearset
Disponibile solo durante l'acquisto di una pedana nuova
- Available on Aprilia RSV4, BMW S1000RR, Yamaha YZF R1 '15/'20
Disponibile per Aprilia RSV4, BMW S1000RR, Yamaha YZF R1 '15/'20
- To verify the possibility in the rearset notes ("P")
Verificare la possibilità nelle note delle pedane ("P")
- Available only for the OEM switch stop with two cables
Disponibile solo per impianti stop originali a due cavi
- Foot pegs, caps and toe pegs in full black
Poggiaiedi, tappi e puntalini neri
- For the complete code see table of folding foot pegs on page. 26 and page 27
Per il codice completo vedere tabella poggiaiedi chiudibili a pag. 26 e pag.27

WARNING ATTENZIONE

- It's possible to find all the spare parts on the specific catalog
- È possibile trovare tutte le parti di ricambio sul catalogo specifico

Folding foot pegs code Codici poggiaiedi chiudibili



Rearsets code Codice pedana	Models Modello	Foot pegs code Codice poggiaiedi	
APRILIA	A003	RSV4 - Tuono V4 ('09/'16)	KPC01
	A004	RSV4 APRC - Tuono V4 APRC (street) ('11/'16)	KPC01
	A004R	RSV4 APRC - Tuono V4 APRC (race) ('11/'16)	KPC01
	A005S	RSV4 APRC - Tuono V4 APRC (street) ('17/ >)	KPC01
	A005SR	RSV4 APRC - Tuono V4 APRC (race) ('17/ >)	KPC01
	A006	RS660 ('20/ >)	KPC01

Rearsets code Codice pedana	Models Modello	Foot pegs code Codice poggiaiedi	
DUCATI	D916	748/916/996/998 ('94/'04)	KPC04
	D999	749/999 ('02/'06)	KPC04
	D1098	848/1098/1198 ('07/'11)	KPC04
	DV2	899/1199/1299 Panigale/V2 ('12/>)	KPC02
	DV4	Panigale V4 ('18/>)	KPC02
	DSTR	Streetfighter ('09/'15)	KPC04
	DSTR3	Streetfighter V2 ('22/>)	KPC02
	DSTR2	Streetfighter V4 ('20/>)	KPC02

Rearsets code Codice pedana	Models Modello	Foot pegs code Codice poggiaiedi	
BMW	B001	S 1000 RR/S 1000 R (street) ('08/'14)	KPC06
	B001R	S 1000 RR/S 1000 R (race) ('08/'14)	KPC01
	B005	S 1000 RR ('15/'18)	KPC01
	B006	S 1000 R ('17/'20)	KPC01
	B007	S 1000 RR ('19/>)	KPC03
	B008	S 1000 R ('21/>)	KPC03

Folding foot pegs code - Codici poggiapiedi chiudibili

Rearsets code Codice pedana	Models Modello	Foot pegs code Codice poggiapiedi
H001	CBR 600 RR (street) ('03/'06)	KPC01
H002	CBR 1000 RR (street) ('04/'07)	KPC01
H003	CBR 600 RR (race) ('03/'06)	KPC01
H004	CBR 1000 RR (race) ('04/'07)	KPC01
H005	CBR 600 RR (street) ('07/>)	KPC01
H006	CBR 600 RR (race) ('07/>)	KPC01
H007	VTR 1000 SP1/SP2 ('00/'06)	KPC01
H008	CBR 1000 RR (street) ('08/'16)	KPC01
H009	CBR 1000 RR (race) ('08/'16)	KPC01
H012	CBR 650 F/CB 650 F ('14/>)	KPC01
H013	CBR 1000 RR Fireblade ('17/'19)	KPC01
H014	CBR 1000 RR Fireblade SP/SP2 ('17/'19)	KPC01
H015	CBR 1000 RR-R Fireblade (racing) ('20/>)	KPC01
H016	CBR 1000 RR-R Fireblade (standard) ('20/>)	KPC01

Rearsets code Codice pedana	Models Modello	Foot pegs code Codice poggiapiedi
K001	ZX-10R ('04/'05)	KPC01
K002	ZX-10R ('06/'07)	KPC01
K003	ZX-6R ('03/'04)	KPC01
K005	ZX-6R ('05/'06)	KPC01
K006	ZX-6R ('07/'08)	KPC01
K008	ZX-10R ('08/'10)	KPC01
K009	Z 750 ('07/'12)	KPC01
K009	Z 1000 ('07/'09)	KPC01
K010	ZX-6R ('09/'17)	KPC01
K011	Z 1000 ('10/'18)	KPC01
K012	ZX-10R ('11/'15)	KPC01
K015	ZX-10R ('16/'20)	KPC01
K017	Z 900 ('17/'19)	KPC01
K018	Z 650 ('17/'19)	KPC01
K019	Ninja 250/400 ('18/>)	KPC01
K020	ZX-6R ('19/>)	KPC01
K021	ZX-10R ('21/>)	KPC02

Rearsets code Codice pedana	Models Modello	Foot pegs code Codice poggiapiedi
KT01	Duke/RC 390 ('14/'20)	KPC06
KT03	Superduke 1290 ('13/'19)	KPC06
KT04	Duke 790/890 ('18/>)	KPC02
KT05	Superduke 1290 ('20/>)	KPC06

Rearsets code Codice pedana	Models Modello	Foot pegs code Codice poggiapiedi
S001	GSX-R 1000 ('05/'06)	KPC01
S004	GSX-R 600/750 ('06/'10)	KPC01
S006	GSX-R 1000 ('07/'08)	KPC01
S007	GSX-R 1000 ('09/'16)	KPC01
S008	GSX-R 600/750 ('11/'17)	KPC01
S009	GSR 750/GSX-S 750 ('11/'20)	KPC01
S011	GSX-R 1000 ('17/>)	KPC01

Rearsets code Codice pedana	Models Modello	Foot pegs code Codice poggiapiedi
TH01	Daytona 675 ('06/'12)	KPC01
TH01	Street Triple 675 ('07/'12)	KPC01
TH03	Daytona 675 ('13/'17)	KPC01
TH03R	Daytona 675 Quickshifter ('13/'17)	KPC01
TH04	Street Triple 675 ('13/'16)	KPC01
TH05	Speed Triple 1050 (street) ('11/'20)	KPC01
TH06	Street Triple 765/800 ('17/'22)	KPC01
TH07	Speed Triple 1200 RR ('22/>)	KPC01
TH08	Speed Triple 1200 RS ('21/>)	KPC01
TH09	Street Triple 765 R/RS/Moto 2 (2023/>)	KPC01

Rearsets code Codice pedana	Models Modello	Foot pegs code Codice poggiapiedi
Y001	YZF R1 ('98/'03)	KPC05
Y002	YZF R1 (street) ('04/'06)	KPC05
Y002R	YZF R1 (race) ('04/'06)	KPC05
Y003	YZF R6 ('99/'02)	KPC05
Y004	YZF R6 ('03/'05)	KPC05
Y005	YZF R6 ('06/'16)	KPC01
Y006	YZF R1 (street) ('07/'08)	KPC01
Y006R	YZF R1 (race) ('07/'08)	KPC01
Y007	YZF R1 ('09/'14)	KPC01
Y008	MT-09/FZ09 ('13/'20)	KPC01
Y010	MT-07/FZ07 ('14/'20)	KPC01
Y011	YZF R1/R1M ('15/>)	KPC01
Y012	YZF R3 ('15/>)	KPC01
Y013	YZF R6 ('17/>)	KPC01
Y014	MT-10/FZ10 ('16/'20)	KPC01
Y015	YZF R7 ('21/>)	KPC05
Y016	MT-09 ('21/>)	KPC05





BMW Motorrad WorldSBK team rider Tom Sykes shows Bonamici Racing rearset



Racing foot pegs / Poggiapiedi racing - cod. RC05 Folding foot pegs / poggiapiedi chiudibili - cod. KPC



Standard folding toe pegs Knurled Folding toe pegs Striped folding toe pegs
 Puntalini chiudibili standard cod. RC02 Puntalini chiudibili godronati cod. RC02G Puntalini chiudibili rigati - cod. RC02R

GEAR SPACER SUPPORT - SUPPORTO DISTANZIALE CAMBIO

Spacer who allows the munting of the rearsets without using the side stand.
 Supporto per montare le pedane senza l'utilizzo del cavalletto laterale.

MODEL - MODELLO	FROM - DAL	TO - AL	CODE - CODICE
Honda CBR 1000RR-R	2020	>	DC_040B
BMW S 1000 RR - M 1000 RR	2019	>	DC_039B
BMW S 1000 R	2021	>	DC_039B
Yamaha YZF R6	2017	>	DC_037B

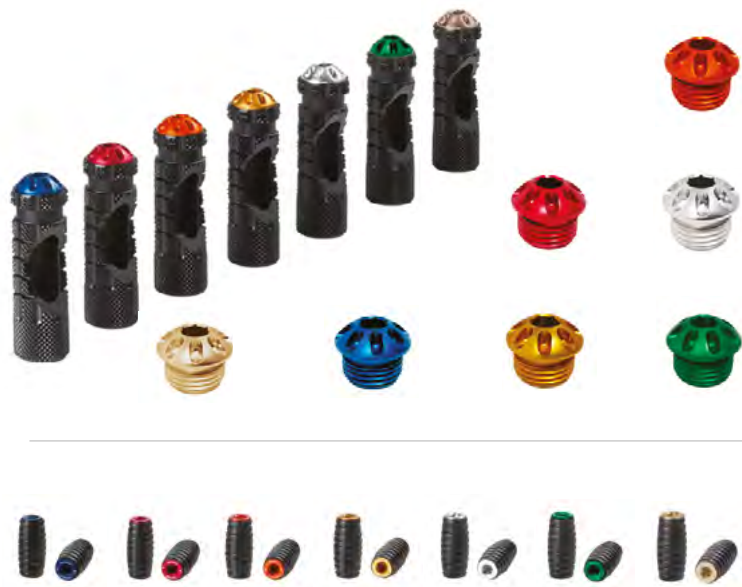

Pairs of caps and standard toe pegs coloured
Coppie di tappi e puntalini standard colorati - cod. RC03

• The rearsets pictured is for illustrative purposes only
• La pedana nella foto è solo a scopo illustrativo



Extra colour for rearset - Colore extra per pedane - cod. KK07



Hydrostop M10 x 1
Interruttore stop idraulico M10 x 1 - cod. HD100

Hydrostop M10 x 1,25
Interruttore stop idraulico M10 x 1,25 - cod. HD125



Wired hydrostop for Ducati
Interruttore stop cablato per Ducati - cod. HDC01



Wired hydrostop for Ducati Streetfighter V4/V2
Interruttore stop cablato per Ducati Streetfighter V4 - cod. HDC02

• The heelplates pictured is for illustrative purposes only
• I paratacchi nella foto sono solo a scopo illustrativo



Laser engravings (one pair)
Incisioni laser (coppia) - cod. KK04



Pair of carbon heel plates
Coppia di paratacchi in carbonio - cod. RC08

BMW Motorrad WorldSBK team rider Scott Redding shows Bonamic Racing rearsets box





1	BULEGA	1:33
2	MANZI	1:33
3	CARACASOLO	1:33
4	MONTELLA	1:33
5	VAN STRALLEE	1:33
6	SCHROEDTER	1:33
7	SOMUOGELU	1:33
8	NAVARRO	1:33
9	MUERTAS	1:33
10	MANTOVANI	1:33
11	SPINELLI	1:33
12	MAHIAS	1:33
13	FULIGNI	1:33
14	BOOTHMAN	1:33
15	BAYLISS	1:33
16	TUUKI	1:33
17	EDWARDS	1:33
18	RUSSELL	1:33
19	BUSSOLOTTI	1:33
20	CHAPMAN	1:33
N. 54 Curr		

ENGINE PROTECTIONS - PROTEZIONI MOTORE



The Bonamici Racing engine protection comes from the collaboration with the teams involved in the World Superbike Championship.

Made by high-strength aluminum alloy, machined from solid with CNC technology and finished with black anodizing, the engine cover kit perfectly protects the carter during falls and slides. It is composed by two or three elements, depending by the model, who protect the carter on both sides of the bike.

The engine protections can be purchased both in kit and individually and it's possible to customize them in other colors or with laser engraving according to customer specifications.

Bonamici Racing boasts the widest range of aluminum engine protections dedicated to the major sport-bikes on the market.

Dalla collaborazione con i team che corrono nel mondiale superbike, nascono le protezioni carter motore della Bonamici Racing.

In lega d'alluminio ad alta resistenza, lavorato dal pieno con tecnologia CNC e rifinito con anodizzazione nera, il kit protegge perfettamente i carter della moto in caso di eventuali cadute.

E' composto da due o tre elementi che proteggono i carter da entrambi i lati della moto. Le protezioni carter sono disponibili sia in kit che singolarmente ed è possibile personalizzarle in altri colori o con incisione laser su specifica del cliente.

Bonamici Racing vanta la più ampia gamma di protezioni motore in alluminio dedicate alle maggiori moto sportive del mercato.



Ducati Panigale V4
Right side - code CP079

APRILIA

MODEL - MODELLO	DESCRIPTION - DESCRIZIONE	FROM - DAL	TO - AL	CODE - CODICE
RSV4 - Tuono V4	right side - lato DX	2009	2020	CP001
RSV4 - Tuono V4	left side - lato SX	2009	2020	CP002
RSV4 - Tuono V4	full kit - kit completo	2009	2020	CP003
RSV4 - RSV4 FACTORY - Tuono V4	right side - lato DX	2021	>	CP001
RSV4 - RSV4 FACTORY - Tuono V4	left side - lato SX	2021	>	CP106
RSV4 - RSV4 FACTORY - Tuono V4	full kit - kit completo	2021	>	CP107
RS 660 - Tuono 660 - Tuareg 660	right side - lato DX	2020	>	CP111
RS 660 - Tuono 660 - Tuareg 660	left side - lato SX	2020	>	CP112
RS 660 - Tuono 660 - Tuareg 660	left side (water pump) lato SX (pompa acqua)	2020	>	CP113
RS 660 - Tuono 660 - Tuareg 660	full kit - kit completo	2020	>	CP114



APRILIA RSV4 - TUONO V4 (2009/2020)
full kit - kit completo - cod. CP003



APRILIA RSV4 Factory (2021 / >)
full kit - kit completo - cod. CP107



APRILIA RS 660 (2020 / >)
full kit - kit completo - cod. CP114

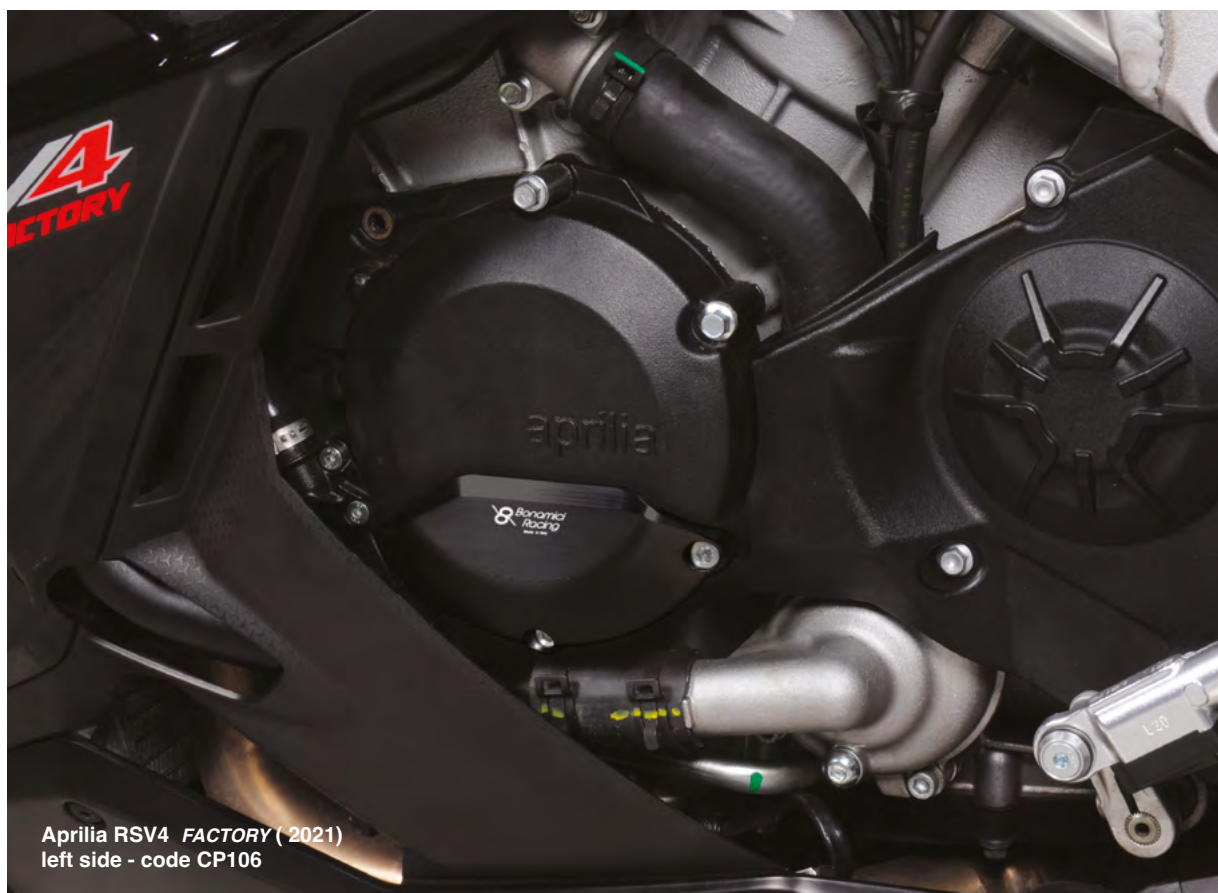

Aprilia RSV4 FACTORY (2021)
left side - code CP106



Aprilia RSV4 FACTORY (2021)
right side - code CP001

MODEL - MODELLO	DESCRIPTION - DESCRIZIONE	FROM - DAL	TO - AL	CODE - CODICE
S 1000 RR - M 1000 RR	right side (pick-up) - lato DX (pick-up)	2019	>	CP084C
S 1000 RR - M 1000 RR	right side (clutch) - lato DX (frizione)	2019	>	CP085B
S 1000 RR - M 1000 RR	left side "racing" (2pcs.) lato SX "racing" (2pz.)	2019	>	CP082B
S 1000 RR - M 1000 RR	left side (water pump) lato SX (pompa acqua)	2019	>	CP083
S 1000 RR - M 1000 RR	full kit "racing" (5pcs.) kit compl. "racing" (5pz.)	2019	>	CP086B
S 1000 R	right side (pick-up) - lato DX (pick-up)	2021	>	CP084C
S 1000 R	right side (clutch) - lato DX (frizione)	2021	>	CP085B
S 1000 R	left side "racing" (2pcs.) lato SX "racing" (2pz.)	2021	>	CP082B
S 1000 R	left side (water pump) lato SX (pompa acqua)	2021	>	CP083
S 1000 R	full kit "racing" (5pcs.) kit compl. "racing" (5pz.)	2021	>	CP086B
S 1000 XR	right side (pick-up) - lato DX (pick-up)	2020	>	CP084C
S 1000 XR	right side (clutch) - lato DX (frizione)	2020	>	CP085B
S 1000 XR	left side - lato SX	2020	>	CP115
S 1000 XR	left side (water pump) lato SX (pompa acqua)	2020	>	CP083
S 1000 XR	full kit (4pcs.) kit completo (4pz.)	2020	>	CP116



BMW S 1000 XR 2020
code CP116



Left side "racing" (2pcs.)
Cod.CP082B

CP086B composed by 5 pieces including the new protection for Crankshaft Sensor (CP082B), the latest invention of Bonamici Racing, especially useful for use on track.

CP086B composto da 5 pezzi tra cui la nuova protezione per Sensore Albero Motore (CP082B), ultima invenzione di Bonamici Racing, particolarmente utile per l'utilizzo in pista.



BMW S 1000 XR (2020 / >) full kit (4 pcs.)
kit completo (4 pz.) - Cod.CP116



CP085B

CP084C



CP083

CP082B

BMW S 1000 RR (2019 / >)
BMW M 1000 RR (2021 / >)
BMW S 1000 R (2021 / >)
full kit (5 pcs.) - kit completo (5 pz.) - Cod.CP086B



BMW S 1000 RR 2023
code CP086B

DUCATI

MODEL - MODELLO	DESCRIPTION - DESCRIZIONE	FROM - DAL	TO - AL	CODE - CODICE
959 Panigale	right side - lato DX	2016	2018	CP007
959 Panigale	left side - lato SX	2016	2018	CP008B
959 Panigale	full kit - kit completo	2016	2018	CP009B
1199/1299 Panigale	right side - lato DX	2012	2018	CP007
1199/1299 Panigale	left side - lato SX	2012	2018	CP008A
1199/1299 Panigale	full kit - kit completo	2012	2018	CP009A
Panigale V4/V4S	right side - lato DX	2018	>	CP079
Panigale V4/V4S	left side - lato SX	2018	>	CP080
Panigale V4/V4S	full kit - kit completo	2018	>	CP081
Panigale V4R	right side - lato DX	2018	>	CP079B
Panigale V4R	left side - lato SX	2018	>	CP080
Panigale V4R	full kit - kit completo	2018	>	CP081B
Panigale V2	right side - lato DX	2020	>	CP007
Panigale V2	left side - lato SX	2020	>	CP104
Panigale V2	full kit - kit completo	2020	>	CP105
Streetfighter V4/V4S	right side - lato DX	2020	2022	CP101
Streetfighter V4/V4S	left side - lato SX	2020	2022	CP102
Streetfighter V4/V4S	full kit - kit completo	2020	2022	CP103
Streetfighter V4/V4S	right side - lato DX	2023	>	CP079
Streetfighter V4/V4S	left side - lato SX	2023	>	CP080
Streetfighter V4/V4S	full kit - kit completo	2023	>	CP081



DUCATI PANIGALE V4 / V4S - full kit - kit completo - cod. CP081



STREETFIGHTER V4/V4S - full kit - kit completo (2020-2022) - cod. CP103



DUCATI 1199 / 1299 PANIGALE - full kit - kit completo - cod. CP009A



Ducati Panigale V4
left side - code CP080





Honda CBR1000RR-R Fireblade (2020 / >)
code CP100



Honda CBR1000RR-R Fireblade (2020/ >)
code CP100



HONDA

PRICES WITHOUT VAT - PREZZI IVA ESCLUSA

MODEL - MODELLO	DESCRIPTION - DESCRIZIONE	FROM - DAL	TO - AL	CODE - CODICE
CBR 1000RR-R Fireblade	right side (distrib.) - lato DX (distrib.)	2020	>	CP097
CBR 1000RR-R Fireblade	right side (clutch) - lato DX (frizione)	2020	>	CP098
CBR 1000RR-R Fireblade	left side - lato SX	2020	>	CP099
CBR 1000RR-R Fireblade	full kit - kit completo	2020	>	CP100

● HONDA CBR1000RR-R FIREBLADE - full kit - kit completo - cod. CP100

KAWASAKI

MODEL - MODELLO	DESCRIPTION - DESCRIZIONE	FROM - DAL	TO - AL	CODE - CODICE
ZX-10R	right side - lato DX	2011	>	CP010
ZX-10R	left side - lato SX	2011	>	CP011
ZX-10R	full kit - kit completo	2011	>	CP012



KTM

MODEL - MODELLO	DESCRIPTION - DESCRIZIONE	FROM - DAL	TO - AL	CODE - CODICE
890 Duke / 890 Duke R	right side (water pump) lato DX (pompa acqua.)	2020	>	CP090
890 Duke / 890 Duke R	right side (clutch) - lato DX (frizione)	2020	>	CP091B
890 Duke / 890 Duke R	left side - lato SX	2020	>	CP092B
890 Duke / 890 Duke R	full kit - kit completo	2020	>	CP093B
1290 Superduke	right side - lato DX	2013	2019	CP058
1290 Superduke	left side - lato SX	2013	2019	CP059
1290 Superduke	full kit - kit completo	2013	2019	CP060
1290 Superduke R	right side - lato DX	2020	>	CP058
1290 Superduke R	left side - lato SX	2020	>	CP059
1290 Superduke R	full kit - kit completo	2020	>	CP060

KAWASAKI ZX-10R - full kit - kit completo - cod. CP012



KTM 890 DUKE - full kit - kit completo - cod. CP093B



KTM 1290 SUPERDUKE R (2020/>) - code CP060



KTM 1290 SUPERDUKE R - full kit - kit completo - cod. CP060



Kawasaki ZX-10R (2011/>)
code CP012

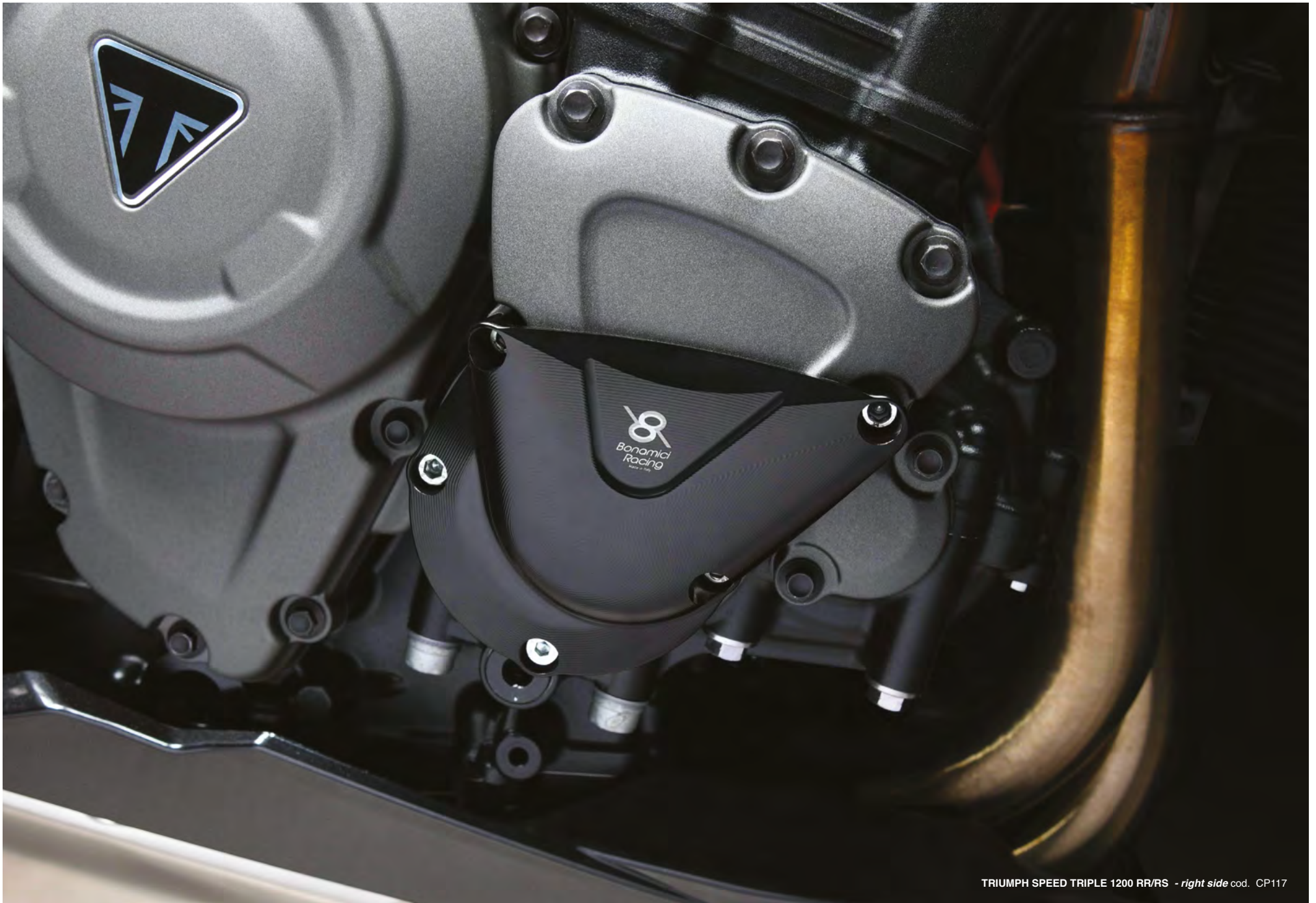

TRIUMPH SPEED TRIPLE 1200 RR/RS - right side cod. CP117



● SUZUKI GSX-R 1000 - full kit - kit completo - cod. CP070



● TRIUMPH SEEP TRIPLE 1200 RR/RS - full kit - kit completo - cod. CP119

SUZUKI

MODEL - MODELLO	DESCRIPTION - DESCRIZIONE	FROM - DAL	TO - AL	CODE - CODICE
GSX-R 1000	right side (distrib.) - lato DX (distrib.)	2017	>	CP067
GSX-R 1000	right side (clutch) - lato DX (frizione)	2017	>	CP068
GSX-R 1000	left side - lato SX	2017	>	CP069
GSX-R 1000	full kit - kit completo	2017	>	CP070

TRIUMPH

MODEL - MODELLO	DESCRIPTION - DESCRIZIONE	FROM - DAL	TO - AL	CODE - CODICE
Street Triple 765 S/R/RS	right side (distrib.) - lato DX (distrib.)	2017	2022	CP071
Street Triple 765 S/R/RS	right side (clutch) - lato DX (frizione)	2017	2022	CP072
Street Triple 765 S/R/RS	left side - lato SX	2017	2022	CP073
Street Triple 765 S/R/RS	full kit - kit completo	2017	2022	CP074
Street Triple 765 R/RS/Moto 2	right side (distrib.) - lato DX (distrib.)	2023	>	CP071
Street Triple 765 R/RS/Moto 2	right side (clutch) - lato DX (frizione)	2023	>	CP072
Street Triple 765 R/RS/Moto 2	left side - lato SX	2023	>	CP073
Street Triple 765 R/RS/Moto 2	full kit - kit completo	2023	>	CP074
Speed Triple1200 RR/RS	right side - lato DX	2021	>	CP117
Speed Triple1200 RR/RS	left side - lato SX	2021	>	CP118
Speed Triple1200 RR/RS	full kit - kit completo	2021	>	CP119



TRIUMPH STREET TRIPLE 765 RS Moto2 - left side cod. CP073

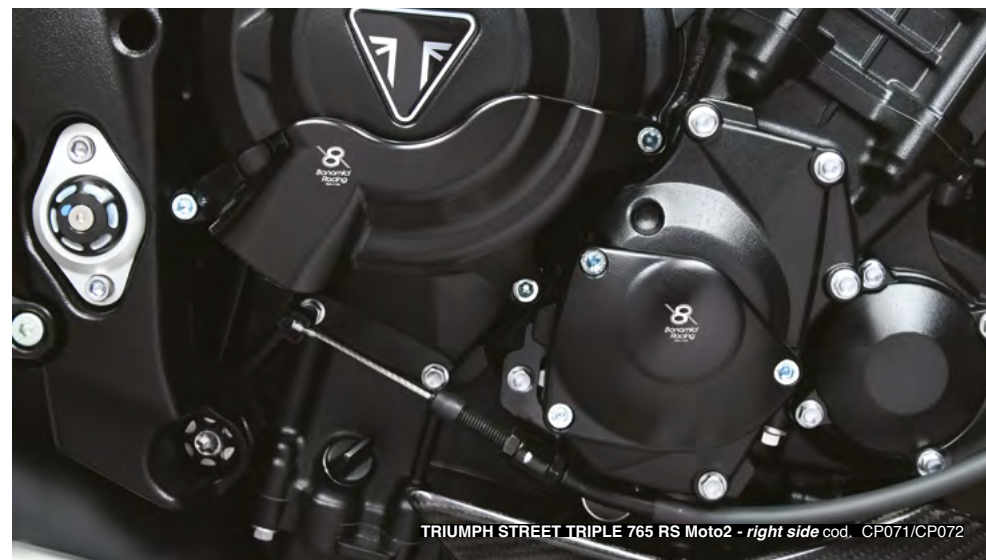

TRIUMPH STREET TRIPLE 765 RS Moto2 - right side cod. CP071/CP072

YAMAHA

MODEL - MODELLO	DESCRIPTION - DESCRIZIONE	FROM - DAL	TO - AL	CODE - CODICE
YZF R3	right side (water pump) lato DX (pompa acqua.)	2015	>	CP051
YZF R3	right side (clutch) - lato DX (frizione)	2015	>	CP052
YZF R3	left side - lato SX	2015	>	CP053
YZF R3	full kit - kit completo	2015	>	CP054
YZF R6	right side (distribution) - lato DX (distribuzione)	2006	>	CP022
YZF R6	right side (clutch) - lato DX (frizione)	2006	>	CP023
YZF R6	left side - lato SX	2006	>	CP024
YZF R6	full kit - kit completo	2006	>	CP025
YZF R1/R1M	right side (distribution) - lato DX (distribuzione)	2015	>	CP044
YZF R1/R1M	right side (clutch) - lato DX (frizione)	2015	>	CP045
YZF R1/R1M	left side - lato SX	2015	>	CP046
YZF R1/R1M	full kit - kit completo	2015	>	CP047
MT-10	right side (distribution) - lato DX (distribuzione)	2016	>	CP044
MT-10	right side (clutch) - lato DX (frizione)	2016	>	CP045
MT-10	left side - lato SX	2016	>	CP061
MT-10	full kit - kit completo	2016	>	CP062



YAMAHA YZF R3 - full kit - kit completo - cod. CP054



YAMAHA YZF R6 - full kit - kit completo - cod. CP025



Yamaha YZF R1/R1 (2015/>)
code CP047



YAMAHA YZF R1/R1M - full kit - kit completo - cod. CP047



Yamaha YZF R1/R1 (2015 / >)
code CP047

ENGINE PROTECTIONS ACCESSORIES - ACCESSORI PROTEZIONI MOTORE

DESCRIPTION - DESCRIZIONE

CODE - CODICE

Laser engravings (kit - 2 engravings) Incisioni laser (kit - 2 incisioni)	KK04P
Extra colour (kit) (*) - Colore extra (kit) (*)	KK07P



Bronze



Silver



Gold



Orange



Red



Blue



WARNING
ATTENZIONE

(*) Available only by purchasing a new kit

(*) Disponibile solo durante l'acquisto di kit nuovo



Our dash protection, news of 2019, born from the strong demand on racing protect the latest generation displays, sophisticated and precious devices. Made from special aluminum who can absorb shocks, with cnc machining, are resistant and safe, in addition, are equipped with an interchangeable Plexiglas protective panel with anti-fog system. Standard color black or silver, other colors on request.

Le protezioni strumentazione, prodotto novità 2019, nascono direttamente dall'uso agonistico per proteggere i display di ultima generazione, veri computer sofisticati e preziosi. Realizzate in alluminio con lavorazione cnc, sono resistentissime e dotate di un pannello protettivo in plexiglas intercambiabile con sistema antiappannamento. Colore standard nero, su richiesta è possibile averle in altri colori.



Ducati Streetfighter V2 (2022/ >)
code DCP11

Honda CBR1000RR-R Fireblade (2020 / >)
code DCP09



DUCATI PANIGALE V4 - cod. DCP03



BMW S 1000 RR / M1000RR / S 1000 R / S 1000 XR - cod. DCP08



HONDA CBR1000RR-R FIREBLADE - cod. DCP09

DASHBOARD PROTECTIONS - PROTEZIONI STRUMENTAZIONE

BRAND	MODEL - MODELLO	FROM - DAL	TO - AL	CODE - CODICE
Aprilia	RS 660 - Tuono 660	2020	>	DCP12
Aprilia	RSV4 Factory / Tuono V4/ Tuareg 660	2021	>	DCP13
Aprilia	RSV4 / Tuono V4	2017	2020	DCP06
BMW	S 1000 RR	2019	>	DCP08
BMW	M 1000 RR	2021	2022	DCP08
BMW	S 1000 R	2021	>	DCP08
BMW	S 1000 XR	2020	>	DCP08
Ducati	Panigale V2	2020	>	DCP11
Ducati	Streetfighter V2	2022	>	DCP11
Ducati	Panigale V4 / V4S / V4R	2018	>	DCP03
Ducati	Streetfighter V4 / V4S	2020	>	DCP10
Honda	CBR 1000 RR-R Fireblade	2020	>	DCP09
Kawasaki	ZX-10R	2021	>	DCP20
Suzuki	GSX-R 1000	2017	>	DCP05
Suzuki	GSX-S 1000	2021	>	DCP05
Yamaha	YZF R3*	2019	>	DCP07
Yamaha	YZF R1 / R1M	2015	>	DCP04
Yamaha	YZF R7	2021	>	DCP16
2D	-	-	-	DCP01
I2M	Chrome lite - Chrome plus	-	-	DCP02
I2M	Chrome PRO 2	-	-	DCP19
ECUMASTER	ADU5	-	2020	DCP14
ECUMASTER	ADU5	2021	>	DCP15
Aim	MXm	-	-	DCP17
Aim	Solo 2 - Solo 2 DL**	-	-	DCP18

SCREEN SPARE PART - VETRINO DI RICAMBIO

BRAND	MODEL - MODELLO	FROM - DAL	TO - AL	CODE - CODICE
Aprilia	RS 660 - Tuono 660	2020	>	SP_DCP12
Aprilia	RSV4 Factory / Tuono V4/ Tuareg 660	2021	>	SP_DCP13
Aprilia	RSV4 / Tuono V4	2017	2020	SP_DCP06
BMW	S 1000 RR	2019	>	SP_DCP08
BMW	M 1000 RR	2021	2022	SP_DCP08
BMW	S 1000 R	2021	>	SP_DCP08
BMW	S 1000 XR	2020	>	SP_DCP08
Ducati	Panigale V2	2020	>	SP_DCP11
Ducati	Streetfighter V2	2022	>	SP_DCP11
Ducati	Panigale V4 / V4S / V4R	2018	>	SP_DCP03
Ducati	Streetfighter V4 / V4S	2020	>	SP_DCP10
Honda	CBR 1000 RR-R Fireblade	2020	>	SP_DCP09
Kawasaki	ZX-10R	2021	>	SP_DCP20
Suzuki	GSX-R 1000	2017	>	SP_DCP05
Suzuki	GSX-S 1000	2021	>	SP_DCP05
Yamaha	YZF R3*	2019	>	SP_DCP07
Yamaha	YZF R1 / R1M	2015	>	SP_DCP04
Yamaha	YZF R7	2021	>	SP_DCP16
2D	-	-	-	SP_DCP01
I2M	Chrome lite - Chrome plus	-	-	SP_DCP02
I2M	Chrome PRO 2	-	-	SP_DCP19
ECUMASTER	ADU5	-	2020	SP_DCP14
ECUMASTER	ADU5	2021	>	SP_DCP15
Aim	MXm	-	-	SP_DCP17
Aim	Solo 2 - Solo 2 DL	-	-	SP_DCP18

Colors available - Colori disponibili

Black



WARNING ATTENZIONE

(* It's possible to mount only with racing fairing - (*) Si può montare solo con le carene racing

(**) Fitting the dashboard protection may not make the GPS signal work - (**) Montando la cover potrebbe non funzionare il segnale GPS

All Bonamici Racing dashboard protectors are not waterproof.

Tutte le protezioni strumentazione Bonamici Racing non sono a tenuta stagna.



APRILIA RSV4 FACTORY / TUONO V4 (2021) - cod. DCP06



Aim MXm - cod. DCP17



Aim Solo2 - cod. DCP18

TOP TRIPLE CLAMP - PIASTRE DI STERZO SUPERIORI

TOP TRIPLE CLAMP STREET VERSION
PIASTRE DI STERZO SUPERIORI VERSIONE STREET



TOP TRIPLE CLAMP RACE VERSION
PIASTRE DI STERZO SUPERIORI VERSIONE RACE

The range of top triple clamps is part of Bonamici Racing innovations for 2019 and stems from the experience gained in international competitions with high-level teams.

Made from solid billet aluminum with numerical control machines, with a modern and appealing design, they are the ideal product to improve performance and driving pleasure without increasing weight.

Two types: "Race" for use on the racetrack "Street" for the assembly of the original ignition block (where provided), no modification or adaptation is required on the stock-bike for assembly.

La gamma di piastre di sterzo superiori fa parte delle novità Bonamici Racing per il 2019 e nascono dall'esperienza maturata nelle competizioni mondiali in team di alto livello.

Realizzate in alluminio con lavorazione cnc, con un disegno moderno ed accattivante, sono il prodotto ideale per migliorare le performance ed il piacere di guida senza incrementare il peso. Due le tipologie: "Race" per l'impiego in pista e "Street" per il montaggio del blocchetto accensione originale (dove previsto), per il montaggio non è richiesta alcuna modifica o adattamento sulla moto di serie.



Ducati Panigale V4
code PSV4



TOP TRIPLE CLAMP - PIASTRE DI STERZO SUPERIORI

BRAND	MODEL - MODELLO	FROM - DAL	TO - AL	CODE - CODICE
Aprilia	RS 660	2020	>	PSA2
Aprilia	RSV4 - RSV4 Factory "Street"	2009	2014	PSA1
		2019	>	
Aprilia	RSV4 - RSV4 Factory "Race" *	2009	2014	PSA1R
		2019	>	
BMW	S 1000 RR "Street"	2015	2018	PSB1
BMW	S 1000 RR "Race" *	2015	2018	PSB1R
BMW	S 1000 RR "Street"	2019	2022	PSB2
BMW	S 1000 RR "Race" *	2019	2022	PSB2R
BMW	S 1000 RR "Street"	2023	>	PSB3
BMW	S 1000 RR "Race" *	2023	>	PSB3R
BMW	M 1000 RR "Street"	2021	>	PSB3
BMW	M 1000 RR "Race" *	2021	>	PSB3R
Ducati	Panigale V2	2020	>	PSV2
Ducati	Panigale V4/V4S	2018	>	PSV4
Ducati	Panigale V4R	2019	2022	PSV4

BRAND	MODEL - MODELLO	FROM - DAL	TO - AL	CODE - CODICE
Honda	CBR 1000 RR "Street"	2017	2019	PSH1
Honda	CBR 1000 RR "Race" *	2017	2019	PSH1R
Honda	CBR 1000RR-R Fireblade	2020	>	PSH2
Kawasaki	ZX-10R "Street"	2016	>	PSK1
Kawasaki	ZX-10R "Race" *	2016	>	PSK1R
Suzuki	GSX-R 1000 "Street"	2017	>	PSS1
Suzuki	GSX-R 1000 "Race" *	2017	>	PSS1R
Triumph	Speed Triple 1200 RR **	2022	>	PST1
Yamaha	YZF R6 "Street"	2017	>	PSY2
Yamaha	YZF R6 "Race" *	2017	>	PSY2R
Yamaha	YZF R1/R1M "Street"	2015	>	PSY1
Yamaha	YZF R1/R1M "Race" *	2015	>	PSY1R
Yamaha	YZF R7 "Street"	2021	>	PSY3
Yamaha	YZF R7 "Race" *	2021	>	PSY3R



- Titanium tightening screws on the forks
- Viti di serraggio sulle forcelle in titanio



Black



Silver

Colors available - Colori disponibili

WARNING ATTENZIONE

(*) is not possible to mount the OEM ignition switch key
 (*) non è possibile rimontare il blocchetto accensione originale
 (**) Equipped with the top tripleclamp plate nut, it is recommended to apply a light layer of grease when fitting the nut
 (**) Dotata del dado della piastra di sterzo, si consiglia al momento del montaggio del dado di applicare un leggero strato di grasso



APRILIA RSV4 "STREET" - cod. PSA1



DUCATI PANIGALE V4 -V4S-V4R - cod. PSV4



HONDA CBR1000RR-R FIREBLADE - cod. PSH2



The new range of brake and clutch lever controls has been redesigned to offer a better feeling of riding with your bike. Made of aluminum machined from solid with foldable lever, are equipped with a hole for air outflow who prevents the actuation if subject to the aerodynamic force. The new levers are more resistant and offer even more precise adjustment, moreover they have more excursion in order to adapt to any type of use. The final tilting part have a shape designed to offer the best grip and ergonomics. More shapes are available on request to satisfy every driving style.

La nuova gamma di comandi leva per freno e frizione è stata riprogettata per offrire un maggior feeling di guida con la propria moto. Realizzate in alluminio ricavate dal pieno con leva ribaltabile, sono dotate di foro per il deflusso aerodinamico che impedisce l'azionamento se soggette alla forza dell'aria. Le nuove leve sono più resistenti ed offrono una regolazione ancora più precisa e con più escursione in modo da adattarsi ad ogni tipo di utilizzo. Hanno inoltre la parte ribaltabile con una forma studiata per offrire la migliore presa ed ergonomia e sono disponibili su richiesta altre forme in modo da soddisfare ogni stile di guida.



APRILIA

MODEL - MODELLO	DESCRIPTION - DESCRIZIONE	FROM - DAL	TO - AL	CODE - CODICE
RSV4 - Factory - APRC	Levers kit - Kit leve	2009	>	KL010
RSV4 - Factory - APRC	Brake lever - Leva freno	2009	>	LB110
RSV4 - Factory - APRC	Clutch lever - Leva frizione	2009	>	LC010
Tuono 1100	Levers kit - Kit leve	2017	>	KL010
Tuono 1100	Brake lever - Leva freno	2017	>	LB110
Tuono 1100	Clutch lever - Leva frizione	2017	>	LC010
RS 660 - Tuono 660	Levers kit - Kit leve	2020	>	KL010
RS 660 - Tuono 660	Brake lever - Leva freno	2020	>	LB110
RS 660 - Tuono 660	Clutch lever - Leva frizione	2020	>	LC010
Tuareg 660	Levers kit - Kit leve	2021	>	KL370
Tuareg 660	Brake lever - Leva freno	2021	>	LB230
Tuareg 660	Clutch lever - Leva frizione	2021	>	LC010



APRILIA RSV4 - FACTORY - APRC - Levers kit - Kit leve - cod. KL010

BMW

MODEL - MODELLO	DESCRIPTION - DESCRIZIONE	FROM - DAL	TO - AL	CODE - CODICE
S 1000 RR - HP4	Levers kit - Kit leve	2008	2014	KL020
S 1000 RR - HP4	Brake lever - Leva freno	2008	2014	LB090
S 1000 RR - HP4	Clutch lever - Leva frizione	2008	2014	LC070
S 1000 RR	Levers kit - Kit leve	2015	2018	KL220
S 1000 RR	Brake lever - Leva freno	2015	2018	LB090
S 1000 RR	Clutch lever - Leva frizione	2015	2018	LC140
S 1000 RR - M 1000 RR * **	Levers kit - Kit leve	2019	>	KL290
S 1000 RR - M 1000 RR *	Brake lever - Leva freno	2019	>	LB090
S 1000 RR - M 1000 RR **	Clutch lever - Leva frizione	2019	>	LC170
S 1000 R	Levers kit - Kit leve	2012	2020	KL220
S 1000 R	Brake lever - Leva freno	2012	2020	LB090
S 1000 R	Clutch lever - Leva frizione	2012	2020	LC140
S 1000 R **	Levers kit - Kit leve	2021	>	KL270
S 1000 R	Brake lever - Leva freno	2021	>	LB200
S 1000 R **	Clutch lever - Leva frizione	2021	>	LC170
S 1000 XR **	Levers kit - Kit leve	2020	>	KL270
S 1000 XR	Brake lever - Leva freno	2020	>	LB200
S 1000 XR **	Clutch lever - Leva frizione	2020	>	LC170



BMW S 1000 RR (2019 >) - Levers kit - Kit leve - cod. KL290



BMW S 1000 R (2021) - Levers kit - Kit leve - cod. KL270

(*) The brake lever may touch with the knob on the instrument frame, when the motorcycle is understeer.

(**) The plastic protection cannot be remounted on the clutch lever.

(*) La leva freno quando la moto è sottosterzo, potrebbe toccare con il pomello sul telaio porta strumentazione.

(**) Non è possibile rimontare la protezione in plastica sulla leva frizione.



BMW S 1000 RR 2023
Brake lever - code LB090

Ducati Panigale V4 (2023 />)
Brake lever - code LB240

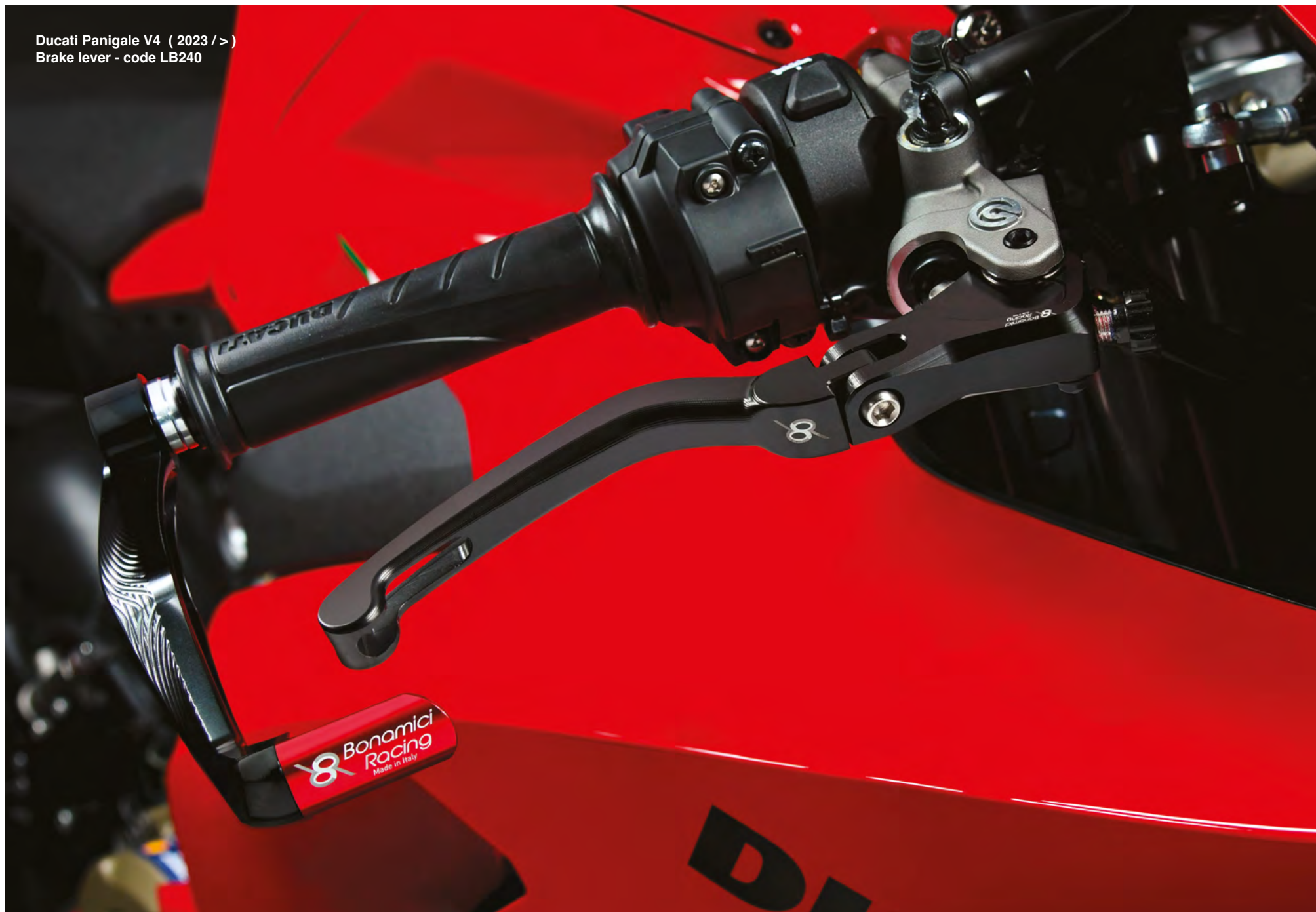



● **DUCATI Levers kit - Kit leve - cod. KL031**



Multistrada V4 (2020/>)

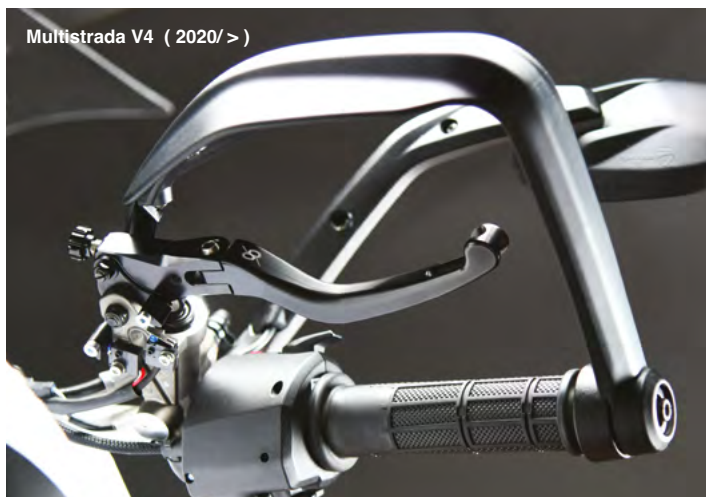

Multistrada V4 (2020/>)

DUCATI

MODEL - MODELLO	DESCRIPTION - DESCRIZIONE	FROM - DAL	TO - AL	CODE - CODICE
Monster 1100	Levers kit - Kit leve	2010	2016	KL031
Monster 1100	Brake lever - Leva freno	2010	2016	LB140
Monster 1100	Clutch lever - Leva frizione	2010	2016	LC061
Monster 1200	Levers kit - Kit leve	2014	2018	KL031
Monster 1200	Brake lever - Leva freno	2014	2018	LB140
Monster 1200	Clutch lever - Leva frizione	2014	2018	LC061
749/999	Levers kit - Kit leve	2002	2006	KL031
749/999	Brake lever - Leva freno	2002	2006	LB140
749/999	Clutch lever - Leva frizione	2002	2006	LC061
848/1098/1198	Levers kit - Kit leve	2007	2012	KL031
848/1098/1198	Brake lever - Leva freno	2007	2012	LB140
848/1098/1198	Clutch lever - Leva frizione	2007	2012	LC061
Panigale V2 899 - 959 - 1199 - 1299 Panigale	Levers kit - Kit leve	2012	>	KL031
Panigale V2 899 - 959 - 1199 - 1299 Panigale	Brake lever - Leva freno	2012	>	LB140
Panigale V2 899 - 959 - 1199 - 1299 Panigale	Clutch lever - Leva frizione	2012	>	LC061
Panigale V4 / V4S / V4R	Levers kit - Kit leve	2018	2022	KL031
Panigale V4 / V4S / V4R	Brake lever - Leva freno	2018	2022	LB140
Panigale V4 / V4S / V4R	Clutch lever - Leva frizione	2018	2022	LC061
Panigale V4 / V4S / V4R	Levers kit - Kit leve	2023	>	KL380
Panigale V4 / V4S / V4R	Brake lever - Leva freno	2023	>	LB240
Panigale V4 / V4S / V4R	Clutch lever - Leva frizione	2023	>	LC061
Streetfighter 848 / 1100	Levers kit - Kit leve	2009	2016	KL031
Streetfighter 848 / 1100	Brake lever - Leva freno	2009	2016	LB140
Streetfighter 848 / 1100	Clutch lever - Leva frizione	2009	2016	LC061
Streetfighter V2	Levers kit - Kit leve	2022	>	KL380
Streetfighter V2	Brake lever - Leva freno	2022	>	LB240
Streetfighter V2	Clutch lever - Leva frizione	2022	>	LC061
Streetfighter V4 / V4S	Levers kit - Kit leve	2020	>	KL031
Streetfighter V4 / V4S	Brake lever - Leva freno	2020	>	LB140
Streetfighter V4 / V4S	Clutch lever - Leva frizione	2020	>	LC061
Multistrada V2 / V2S	Levers kit - Kit leve	2021	>	KL032
Multistrada V2 / V2S	Brake lever - Leva freno	2021	>	LB141
Multistrada V2 / V2S	Clutch lever - Leva frizione	2021	>	LC062
Multistrada V4 V4S / V4S Sport / V4 Pikes Peak	Levers kit - Kit leve	2020	>	KL380
Multistrada V4 V4S / V4S Sport / V4 Pikes Peak	Brake lever - Leva freno	2020	>	LB240
Multistrada V4 V4S / V4S Sport / V4 Pikes Peak	Clutch lever - Leva frizione	2020	>	LC061

HONDA

MODEL - MODELLO	DESCRIPTION - DESCRIZIONE	FROM - DAL	TO - AL	CODE - CODICE
CBR 500 R - CB 500 F	Levers kit - Kit leve	2019	>	KL350
CBR 500 R - CB 500 F	Brake lever - Leva freno	2019	>	LB180
CBR 500 R - CB 500 F	Clutch lever - Leva frizione	2019	>	LC220
CBR 600 RR	Levers kit - Kit leve	2007	>	KL040
CBR 600 RR	Brake lever - Leva freno	2007	>	LB150
CBR 600 RR	Clutch lever - Leva frizione	2007	>	LC020
CBR 1000 RR	Levers kit - Kit leve	2008	2019	KL040
CBR 1000 RR	Brake lever - Leva freno	2008	2019	LB150
CBR 1000 RR	Clutch lever - Leva frizione	2008	2019	LC020
CBR 1000 RR-R Fireblade	Levers kit - Kit leve	2020	>	KL040
CBR 1000 RR-R Fireblade	Brake lever - Leva freno	2020	>	LB150
CBR 1000 RR-R Fireblade	Clutch lever - Leva frizione	2020	>	LC020
CBR 1000 RR-R Fireblade SP	Levers kit - Kit leve	2020	>	KL310
CBR 1000 RR-R Fireblade SP	Brake lever - Leva freno	2020	>	LB110
CBR 1000 RR-R Fireblade SP	Clutch lever - Leva frizione	2020	>	LC020



HONDA CBR1000RR-R FIREBLADE SP
Levers kit - Kit leve - cod. KL310



Honda CBR1000RR-R Fireblade (2020/21)
code KL040



KAWASAKI NINJA 250/400
Levers kit - Kit leve - cod. KL260



KAWASAKI ZX-10R (2016 ->)
Levers kit - Kit leve - cod. KL210



KTM 790 DUKE - Levers kit - Kit leve - cod. KL300

KAWASAKI

MODEL - MODELLO	DESCRIPTION - DESCRIZIONE	FROM - DAL	TO - AL	CODE - CODICE
Ninja 300 (ZX-3R)	Levers kit - Kit leve	2014	2017	KL260
Ninja 300 (ZX-3R)	Brake lever - Leva freno	2014	2017	LB180
Ninja 300 (ZX-3R)	Clutch lever - Leva frizione	2014	2017	LC160
Ninja 250/400	Levers kit - Kit leve	2018	>	KL260
Ninja 250/400	Brake lever - Leva freno	2018	>	LB180
Ninja 250/400	Clutch lever - Leva frizione	2018	>	LC160
ZX-6R - ZX-6R 636	Levers kit - Kit leve	2005	2017	KL110
ZX-6R - ZX-6R 636	Brake lever - Leva freno	2005	2017	LB160
ZX-6R - ZX-6R 636	Clutch lever - Leva frizione	2005	2017	LC040
ZX-10R	Levers kit - Kit leve	2006	2015	KL110
ZX-10R	Brake lever - Leva freno	2006	2015	LB160
ZX-10R	Clutch lever - Leva frizione	2006	2015	LC040
ZX-10R	Levers kit - Kit leve	2016	>	KL210
ZX-10R	Brake lever - Leva freno	2016	>	LB110
ZX-10R	Clutch lever - Leva frizione	2016	>	LC040

KTM

MODEL - MODELLO	DESCRIPTION - DESCRIZIONE	FROM - DAL	TO - AL	CODE - CODICE
790/890 Duke	Levers kit - Kit leve	2018	>	KL300
790/890 Duke	Brake lever - Leva freno	2018	>	LB190
790/890 Duke	Clutch lever - Leva frizione	2018	>	LC180
890 Duke R	Levers kit - Kit leve	2021	>	KL320
890 Duke R	Brake lever - Leva freno	2021	>	LB210
890 Duke R	Clutch lever - Leva frizione	2021	>	LC180
1290 Superduke R	Levers kit - Kit leve	2020	>	KL280
1290 Superduke R	Brake lever - Leva freno	2020	>	LB110
1290 Superduke R	Clutch lever - Leva frizione	2020	>	LC200

MV AGUSTA

MODEL - MODELLO	DESCRIPTION - DESCRIZIONE	FROM - DAL	TO - AL	CODE - CODICE
F3 675/ F3 800	Levers kit - Kit leve	2011	>	KL200
F3 675/ F3 800	Brake lever - Leva freno	2011	>	LB090
F3 675/ F3 800	Clutch lever - Leva frizione	2011	>	LC110



Triumph Speed Triple 1200 RR (2022/ >) - code KL360

SUZUKI



SUZUKI GSX-R 1000 - Levers kit - Kit leve - cod. KL170



TRIUMPH STREET TRIPLE 765 R - Levers kit - Kit leve - cod. KL390



TRIUMPH SPEED TRIPLE 1200 RR/RS - Levers kit - Kit leve - cod. KL360

MODEL - MODELLO	DESCRIPTION - DESCRIZIONE	FROM - DAL	TO - AL	CODE - CODICE
GSX-R 600/ GSX-R 750	Levers kit - Kit leve	2006	2010	KL120
GSX-R 600/ GSX-R 750	Brake lever - Leva freno	2006	2010	LB090
GSX-R 600/ GSX-R 750	Clutch lever - Leva frizione	2006	2010	LC010
GSX-R 600/ GSX-R 750	Levers kit - Kit leve	2011	2017	KL170
GSX-R 600/ GSX-R 750	Brake lever - Leva freno	2011	2017	LB090
GSX-R 600/ GSX-R 750	Clutch lever - Leva frizione	2011	2017	LC090
GSX-R 1000	Levers kit - Kit leve	2005	2006	KL120
GSX-R 1000	Brake lever - Leva freno	2005	2006	LB090
GSX-R 1000	Clutch lever - Leva frizione	2005	2006	LC010
GSX-R 1000	Levers kit - Kit leve	2009	2010	KL120
GSX-R 1000	Brake lever - Leva freno	2009	2010	LB090
GSX-R 1000	Clutch lever - Leva frizione	2009	2010	LC010
GSX-R 1000	Levers kit - Kit leve	2011	>	KL170
GSX-R 1000	Brake lever - Leva freno	2011	>	LB090
GSX-R 1000	Clutch lever - Leva frizione	2011	>	LC090
GSX-S 1000	Levers kit - Kit leve	2021	>	KL330
GSX-S 1000	Brake lever - Leva freno	2021	>	LB201
GSX-S 1000	Clutch lever - Leva frizione	2021	>	LC210

TRIUMPH

MODEL - MODELLO	DESCRIPTION - DESCRIZIONE	FROM - DAL	TO - AL	CODE - CODICE
Daytona 675 R	Levers kit - Kit leve	2011	2016	KL180
Daytona 675 R	Brake lever - Leva freno	2011	2016	LB110
Daytona 675 R	Clutch lever - Leva frizione	2011	2016	LC080
Daytona 675	Clutch lever - Leva frizione	2011	2016	LC080
Speed Triple 1050/1050 R	Levers kit - Kit leve	2011	2017	KL180
Speed Triple 1050/1050 R	Brake lever - Leva freno	2011	2017	LB110
Speed Triple 1050/1050 R	Clutch lever - Leva frizione	2011	2017	LC080
NEW Street Triple 765 R	Levers kit - Kit leve	2023	>	KL390
Street Triple 765 R	Brake lever - Leva freno	2023	>	LB200
Street Triple 765 R	Clutch lever - Leva frizione	2023	>	LC080
Street Triple 765 RS/Moto 2	Levers kit - Kit leve	2023	>	KL360
Street Triple 765 RS/Moto 2	Brake lever - Leva freno	2023	>	LB210
Street Triple 765 RS/Moto 2	Clutch lever - Leva frizione	2023	>	LC230
Speed Triple 1200 RR/RS	Levers kit - Kit leve	2021	>	KL360
Speed Triple 1200 RR/RS	Brake lever - Leva freno	2021	>	LB210
Speed Triple 1200 RR/RS	Clutch lever - Leva frizione	2021	>	LC230

YAMAHA

MODEL - MODELLO	DESCRIPTION - DESCRIZIONE	FROM - DAL	TO - AL	CODE - CODICE
YZF R3	Levers kit - Kit leve	2015	>	KL250
YZF R3	Brake lever - Leva freno	2015	>	LB170
YZF R3	Clutch lever - Leva frizione	2015	>	LC150
YZF R6	Levers kit - Kit leve	2006	2016	KL240
YZF R6	Brake lever - Leva freno	2006	2016	LB140
YZF R6	Clutch lever - Leva frizione	2006	2016	LC010
YZF R6	Levers kit - Kit leve	2017	>	KL230
YZF R6	Brake lever - Leva freno	2017	>	LB100
YZF R6	Clutch lever - Leva frizione	2017	>	LC010
YZF R1	Levers kit - Kit leve	2004	2014	KL240
YZF R1	Brake lever - Leva freno	2004	2014	LB140
YZF R1	Clutch lever - Leva frizione	2004	2014	LC010
YZF R1/R1M	Levers kit - Kit leve	2015	>	KL231
YZF R1/R1M	Brake lever - Leva freno On this lever is not possible mount the remote adjuster. The lever with remote adjuster for YZF R1 '15/20 has code RALB100. Su questa leva non è possibile montare il registro remoto codice 00BR. L'unica leva con registro remoto utilizzabile sulla YZF R1 '15/> è quella con codice RALB100	2015	>	LB101
YZF R1/R1M	Clutch lever - Leva frizione	2015	>	LC010
YZF R7	Levers kit - Kit leve	2021	>	KL340
YZF R7	Brake lever - Leva freno It can only be mounted on Bonamici Racing handlebars Code SM50B Può essere montata solo sui semimanubri Bonamici Racing Codice SM50B	2021	>	LB220
YZF R7	Clutch lever - Leva frizione	2021	>	LC010
MT-09	Levers kit - Kit leve	2021	>	KL231
MT-09	Brake lever - Leva freno	2021	>	LB101
MT-09	Clutch lever - Leva frizione	2004	>	LC010



YAMAHA YZF R6 2017 - Levers kit - Kit leve - cod. KL230



YAMAHA YZF R1/R1M - Levers kit - Kit leve - cod. KL231

BREMBO

MODEL - MODELLO	DESCRIPTION - DESCRIZIONE	FROM - DAL	TO - AL	CODE - CODICE
16 X 18 - 19 X 18	Brake lever - Leva freno	-	-	LB070
19 X 20	Brake lever - Leva freno	-	-	LB080
RCS	Brake lever - Leva freno Aluminium half lever Solo la parte terminale in alluminio	-	-	LB120
Racing	Brake lever - Leva freno Aluminium half lever Solo la parte terminale in alluminio	-	-	LB120R
Corsa Corta	Brake lever - Leva freno Aluminium half lever Solo la parte terminale in alluminio	-	-	LB120CC
MCS	Brake lever - Leva freno	-	-	LB210



BREMBO CORSA CORTA - Brake lever - Leva freno - cod. LB120CC



Yamaha YZF R1/R1M (2015/>)
code KL231

FULL CLUTCH LEVERS - LEVE FRIZIONE COMPLETE



ADJUSTABLE - REGOLABILE

DESCRIPTION - DESCRIZIONE CODE - CODICE

Offset 24mm	LCFR24
Offset 27mm	LCFR27
Offset 29mm	LCFR29
Offset 32mm	LCFR32
Offset 34mm	LCFR34

NOT ADJUSTABLE - NON REGOLABILE

DESCRIPTION - DESCRIZIONE CODE - CODICE

Offset 24mm	LCF24
Offset 27mm	LCF27
Offset 29mm	LCF29
Offset 32mm	LCF32
Offset 34mm	LCF34

WARNING ATTENZIONE

Product for racing use only, it is not possible to install the (OEM) switch
Prodotto esclusivamente per uso racing, non è possibile installare lo switch di serie

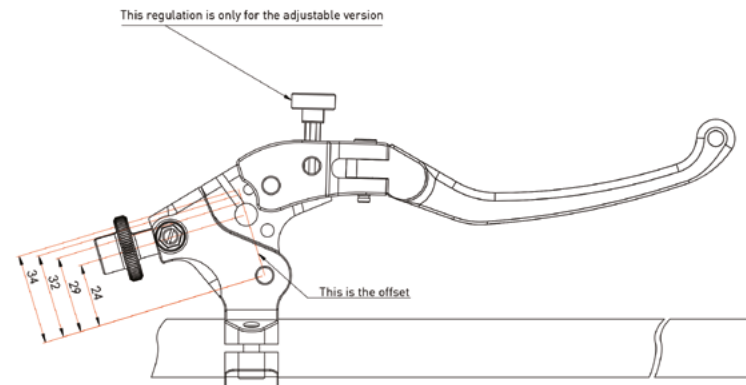

NOTES - NOTE

HOW TO CHOSE THE OFFSET

At the purchase time it is necessary to choose the ideal offset keeping in mind the following: greater is the offset, greater will be the hardness of the lever with a faster detachment. To determine the offset of the original lever, perform the measurement as in the picture.

COME SCEGLIERE L'OFFSET

Al momento dell'acquisto occorre scegliere l'offset ideale tenendo presente che maggiore è l'offset e maggiore sarà la durezza della leva con uno stacco più rapido.
Per stabilire l'offset della leva originale eseguire la misurazione come in foto





BRAKE LEVERS WITH REMOTE ADJUSTER - LEVE FRENO CON REGISTRO REMOTO



BRAKE LEVERS WITH RACING REMOTE ADJUSTER
LEVE FRENO CON REGISTRO REMOTO RACING



BRAKE LEVERS WITH REMOTE ADJUSTER
LEVE FRENO CON REGISTRO REMOTO

BRAND	MODEL - MODELLO	FROM - DAL	TO - AL	CODE - CODICE	
				Standard version	Racing version
Aprilia	RS 660 - TUONO 660	2020	>	RALB110	RALB110R
Aprilia	RSV4 - Factory - APRC	2009	>	RALB110	RALB110R
Aprilia	Tuono 1100	2017	2020	RALB110	RALB110R
BMW	S 1000 R	2012	2020	RALB090	RALB090R
BMW	S 1000 R	2021	>	RALB200	RALB200R
BMW	S 1000 RR - M 1000 RR - HP4	2008	>	RALB090	RALB090R
Ducati	749/999	2002	2006	RALB140	RALB140R
Ducati	848/1098/1198	2007	2012	RALB140	RALB140R
Ducati	899/1199/1299 Panigale/V2	2012	>	RALB140	RALB140R
Ducati	Streetfighter V2	2022	>	RALB240	RALB240R
Ducati	Panigale V4/V4S/V4R	2018	2022	RALB140	RALB140R
Ducati	Panigale V4/V4S/V4R	2023	>	RALB240	RALB240R
Honda	CBR 500 R - CB 500 F	2019	>	RALB180	RALB180R
Honda	CBR 600 RR	2007	>	RALB150	RALB150R
Honda	CBR 1000 RR	2004	2019	RALB150	RALB150R
Honda	CBR 1000 RR-R Fireblade	2020	>	RALB150	RALB150R
Honda	CBR 1000 RR-R Fireblade SP	2020	>	RALB110	RALB110R
Kawasaki	Ninja 300 (ZX-3R)	2014	2017	RALB180	RALB180R
Kawasaki	Ninja 250/400	2018	>	RALB180	RALB180R
Kawasaki	ZX-6R	2005	2017	RALB160	RALB160R
Kawasaki	ZX-10R	2006	2015	RALB160	RALB160R
Kawasaki	ZX-10R	2016	>	RALB110	RALB110R
KTM	790 / 890 Duke	2018	>	RALB190	RALB190R
KTM	890 Duke R	2021	>	RALB210	RALB210R
KTM	1290 Superduke R	2020	>	RALB110	RALB110R
MV Agusta	F3 675/800	2011	>	RALB090	RALB090R
Suzuki	GSX-R 600/750/1000	2004	>	RALB090	RALB090R
Suzuki	GSX-S 1000	2021	>	RALB201	RALB201R
Triumph	Daytona 675 R	2011	2016	RALB110	RALB110R
Triumph	Speed triple 1200 RR/RS	2021	>	RALB210	RALB210R
Triumph	Street triple 765 R	2023	>	RALB200	RALB200R
Triumph	Street triple 765 RS/Moto2	2023	>	RALB210	RALB210R
Yamaha	YZF R3	2015	>	RALB170	RALB170R
Yamaha	YZF R6	2006	2016	RALB140	RALB140R
Yamaha	YZF R6	2017	>	RALB100	RALB100R
Yamaha	YZF R1	2004	2014	RALB140	RALB140R
Yamaha	YZF R1/R1M	2015	>	RALB100	RALB100R
Yamaha	YZF R7	2021	>	RALB220	RALB220R
Brembo	16x18	-	-	RALB070	RALB070R
Brembo	19x18	-	-	RALB070	RALB070R
Brembo	19x20	-	-	RALB080	RALB080R
Brembo	MCS	-	-	RALB210	RALB210R

RACING REMOTE ADJUSTER - REGISTRO REMOTO RACING

MODEL - MODELLO	CODE - CODICE
Bonamici Racing	RRP_BR
Brembo original pump - Brembo pompa di serie	RRP_37
Brembo 16x18/19x18/19x20	RRP_37/R
Brembo RCS/RCS Corsa Corta	RRP_43

BRAKE LEVER ATTACHMENT - ATTACCO LEVA FRENO

Cod. 0037/R

Cod. 0043

Cod. 0037

Cod. 0038
Cod. 0041
Cod. 0042



REMOTE ADJUSTER - REGISTRO REMOTO

MODEL - MODELLO	CODE - CODICE
Bonamici Racing	00BR
Braking	0042
Brembo original pump - Brembo pompa di serie	0037
Brembo 16x18/19x18/19x20	0037/R
Brembo RCS/RCS Corsa Corta	0043
Discacciati	0038
PT	0041



REMOTE ADJUSTER
REGISTRO REMOTO

RACING REMOTE ADJUSTER
REGISTRO REMOTO RACING

SPARE PARTS REMOTE ADJUSTER - RICAMBI REGISTRO REMOTO

DESCRIPTION - DESCRIZIONE	CODE - CODICE
Knob for remote adjuster - Pomello per registro remoto	REGPO
Knob for remote adjuster Racing - Pomello per registro remoto Racing	RRP4
Joint for remote adjuster - Snodo per registro remoto	REGSN
Joint for remote adjuster Racing - Snodo per registro remoto Racing	RRP1
Bracelet for remote adjuster - Collare per registro remoto	REGCO-3
Bracelet for remote adjuster Racing - Collare per registro remoto Racing	RRP2-3
Short cable (52,5cm) for remote adjuster - Cavo corto (52,5cm) per registro remoto	REGCC
Long cable (77,5cm) for remote adjuster - Cavo lungo (77,5cm) per registro remoto	REGCL
Adjuster connection for Bonamici levers - Attacco registro remoto per leve Bonamici	00BRA
Adjuster connection for Brembo OEM - Attacco registro remoto per Brembo di serie	0037A
Adjuster connection for Brembo 16x18 - 19x18 - 19x20 Attacco registro remoto per Brembo 16x18 - 19x18 - 19x20	0037RA
Adjuster connection for Brembo RCS - Attacco registro remoto per Brembo RCS	0043RA
Adjuster connection for Discacciati / PT / Braking Attacco registro remoto per Discacciati / PT / Braking	0038A

LEVERS ACCESSORIES AND SPARE PARTS - ACCESSORI E RICAMBI LEVE

The full range of Bonamici Racing levers is supplied with the half-lever in "standard" version code LL05 in black color. During the purchase it is possible to request the half-lever in "straight" version code LL03 or "racing" version code LL04, different colors and laser engraving are also available. The Bronze color is only available for LL05 levers

L'intera gamma leve Bonamici Racing è fornita con la parte finale della leva nella versione "Standard" codice LL05 di colore nero. Al momento dell'acquisto è possibile richiedere la leva nella versione "Dritta" codice LL03 o "Racing" codice LL04, diversi colori e incisione laser, Il colore Bronzo è disponibile solo per le leve LL05

DESCRIPTION - DESCRIZIONE	COLOUR- COLORE	CODE - CODICE
Colour kit for Bonamici Racing half levers Kit colore per leve Bonamici Racing	black - blue - green - gold orange - red - silver bronze	KLC
Laser engraving (kit) - Incisione laser (kit)	-	KLS
Aluminium half lever "Standard" (RH/LH) Leva in alluminio "Standard" (DX/SX)	black - blue - green - gold orange - red - silver bronze	LL05
Aluminium half lever "Straight" (RH/LH) Leva in alluminio "Dritta" (DX/SX)	black - blue - green - gold orange - red - silver	LL03
Aluminium half lever "Racing" (RH/LH) Leva in alluminio "Racing" (DX/SX)	black	LL04

WARNING
ATTENZIONE

The bronze color is only available for the "Standard" lever code LL05
Il colore bronzo è disponibile solo per leve "Standard" codice LL05



Colour for half lever - Colore parte finale leve



Aluminium half lever "Standard" (RH/LH) - Leva in alluminio "Standard" (DX/SX) - cod. LL05



Aluminium half lever "Straight" (RH/LH) - Leva in alluminio "Dritta" (DX/SX) - cod. LL03



Aluminium half lever "Racing" (RH/LH) Leva in alluminio "Racing" (DX/SX) - cod. LL04



LEVER PROTECTIONS - PROTEZIONE LEVE

CARBON LEVER PROTECTION

Made of fine carbon fiber, 100% made in Italy, extremely detailed both internal and external surfaces, it guarantees maximum strength and low weight. This new particular design has been studied in detail through aerodynamics and fluid dynamics studies to reduce the air pressure both on the lever guard itself and on the brake command at high speeds. . The new design of the lever guard has been created to favor a wide movement of the hand and wrist in the various riding phases and also to facilitate the rapid release of the hand in the event of a fall or accident.

In addition to being a fundamental element for safety, the Bonamici Racing carbon shift guard is a real design object that gives the bike a very beautiful and sporty look. The peculiarity of the new carbon lever guard is that it is supplied with a titanium screw and it is possible to adjust its position both in the longitudinal axis and in the transversal axis thanks to a new bushing system mounted between the handlebar and the lever guard itself. One of a kind. The new carbon lever guard is equipped with an ADL16_C adapter, perfect for Bonamici Racing handlebars. For other uses, we recommend consulting the adapter list and requesting the most suitable one for your motorcycle model.

PROTEZIONE LEVA IN CARBONIO

Realizzata in pregiata fibra di carbonio, 100% made in Italy, estremamente dettagliata in entrambe le superfici interna ed esterna, garantisce massima robustezza e peso contenuto. Questo nuovo particolare design è stato studiato nei minimi dettagli attraverso studi di aerodinamica e fluidodinamica per ridurre la pressione dell'aria sia sul paraleva stesso che sul comando del freno alle alte velocità. .

Il nuovo design del paraleva è stato realizzato per favorire un ampio movimento della mano e del polso nelle varie fasi di guida e anche per facilitare il rapido rilascio della mano in caso di caduta o incidente.

Oltre ad essere un elemento fondamentale per la sicurezza, il paraleva in carbonio Bonamici Racing è un vero e proprio oggetto di design che dona alla moto un aspetto molto bello e sportivo. La particolarità del nuovo paraleva in carbonio è che viene fornito con vite in titanio ed è possibile aggiustarne la posizione sia in asse longitudinale sia in asse trasversale grazie ad un nuovo sistema a boccola montato tra il manubrio ed il paraleva stesso. Unico nel suo genere. Il nuovo paraleva in carbonio è dotato di adattatore ADL16_C, perfetto per semimanubri Bonamici Racing, per altri usi consigliamo di consultare l'elenco adattatori e richiedere quello più adatto al vostro modello di moto.



Code: LPLITE_R

CARBON LEVER PROTECTIONS - PROTEZIONE LEVE IN CARBONIO

DESCRIPTION - DESCRIZIONE

CODE - CODICE

Brake side*- Lato freno*

LPLITE_R

ADAPTORS - ADATTATORI

DESCRIPTION - DESCRIZIONE

CODE - CODICE

for Bonamici Racing bars tube - per tubi manubrio Bonamici Racing	ADLT_C
from ø13mm to ø 14mm tube - per tubo da ø13mm a ø14mm	ADL13_C
from ø14mm to ø 15mm tube - per tubo da ø14mm a ø15mm	ADL14_C
from ø15mm to ø 16mm tube - per tubo da ø15mm a ø16mm	ADL15_C
from ø16mm to ø 17mm tube - per tubo da ø16mm a ø17mm	ADL16_C
from ø17mm to ø 18mm tube - per tubo da ø17mm a ø18mm	ADL17_C
from ø18mm to ø 19mm tube - per tubo da ø18mm a ø19mm	ADL18_C
from ø19mm to ø 20mm tube - per tubo da ø19mm a ø20mm	ADL19_C
from ø20mm to ø 21mm tube - per tubo da ø20mm a ø21mm	ADL20_C
Aprilia RS 660	ADL660_C
Aprilia RSV4/RSV4 Factory (2009/>)	ADLA_C
BMW S 1000 RR (2008-2018)	ADLB_C
BMW S 1000 RR (2019->)	ADLRR_C
Ducati Panigale V4	ADL17_C
Ducati Streetfighter V2	ADLSV2_C
Honda CBR1000RR-R Fireblade (2020/>)	ADLH19_C
Honda CBR 1000 RR (2008/2016)	ADL19_C
Honda CBR 600 RR	ADL19_C
Kawasaki ZX-10R (2011/>)	ADLZX_C
Kawasaki Ninja 400	ADLRR_C
MV Agusta F3 675/800	ADL18_C
MV Agusta F4	ADL16_C
MV Agusta Brutale 675/800	ADL14_C
Suzuki GSX-R 1000 (2017/>)	ADLRR_C
Triumph Speed Triple 1200 RS	ADL660_C
Triumph Speed Triple 1200 RR	ADLST_C
Triumph Street Triple 765 R/RS/RS Moto2 (2023/>)	ADL765_C
Yamaha YZF R1 (1998/>)	ADLY_C
Yamaha YZF R3 (2015/>)	ADLY_C
Yamaha YZF R6 (2006/>)	ADLY_C
Yamaha YZF R7 (2021/>)	ADLY_C
Yamaha MT-09 (2021/>)	ADLY_C

WARNING ATTENZIONE

(*) the lever protection includes the ADL16_C adaptor, for other application please choose the correct adaptor. (*) il paraleva viene fornito con l'adattatore ADL16_C, per altri impieghi consultare la lista degli adattatori.



LEVER PROTECTIONS - PROTEZIONE LEVE



FRONT PEG SILVER
PUNTALINO ARGENTO



FRONT PEG BRONZE
PUNTALINO BRONZO



FRONT PEG GOLD
PUNTALINO ORO



FRONT PEG ORANGE
PUNTALINO ARANCIO



FRONT PEG RED
PUNTALINO ROSSO



FRONT PEG GREEN
PUNTALINO VERDE



FRONT PEG BLUE
PUNTALINO BLU

WARNING ATTENZIONE

(*) the lever protection includes the ADL16 adaptor, for other application please choose the correct adaptor.

(*) il paraleva viene fornito con l'adattatore ADL16, per altri impieghi consultare la lista degli adattatori.

ALUMINUM LEVER PROTECTIONS - PROTEZIONE LEVE IN ALLUMINIO

DESCRIPTION - DESCRIZIONE	COLOUR - COLORE	CODE - CODICE
Brake side* - Lato freno*	black - blue - bronze - green gold orange - red - silver	LPRR
Brake side (short version)* Lato freno (tipo corto)*	black - blue - bronze - green gold orange - red - silver	LPRC
Clutch side* - Lato frizione*	black - blue - bronze - green gold orange - red - silver	LPRL
Front peg spare part(brake side) Puntalino di ricambio (lato freno)	black - blue - bronze - green gold orange - red - silver	LPP_DX
Front peg spare part(clutch side) Puntalino di ricambio (lato frizione)	black - blue - bronze - green gold orange - red - silver	LPP_SX
Laser engraving - Incisione laser	-	LLS
BMW S 1000 R (2021 / >) Brake side - Lato freno	black - blue - bronze - green gold orange - red - silver	LPRR10
BMW S 1000 R (2021 / >) Clutch side - Lato frizione	black - blue - bronze - green gold orange - red - silver	LPRL10

ADAPTORS - ADATTATORI

DESCRIPTION - DESCRIZIONE	CODE - CODICE	
for Bonamici Racing bars tube - per tubi manubrio Bonamici Racing	ADLT	26,00
for SM55S1K handlebars - per semimanubri SM55S1K	ADLS1K	52,00
from ø13mm to ø 14mm tube - per tubo da ø13mm a ø14mm	ADL13	30,00
from ø14mm to ø 15mm tube - per tubo da ø14mm a ø15mm	ADL14	30,00
from ø15mm to ø 16mm tube - per tubo da ø15mm a ø16mm	ADL15	30,00
from ø16mm to ø 17mm tube - per tubo da ø16mm a ø17mm	ADL16	30,00
from ø17mm to ø 18mm tube - per tubo da ø17mm a ø18mm	ADL17	30,00
from ø18mm to ø 19mm tube - per tubo da ø18mm a ø19mm	ADL18	30,00
from ø19mm to ø 20mm tube - per tubo da ø19mm a ø20mm	ADL19	30,00
from ø20mm to ø 21mm tube - per tubo da ø20mm a ø21mm	ADL20	30,00
Aprilia RS 660	ADL660	20,00
Aprilia RSV4/RSV4 Factory (2009/>)	ADLA	30,00
BMW S 1000 RR (2008-2018)	ADLB	30,00
BMW S 1000 RR (2019->)	ADLRR	20,00
Ducati Panigale V4	ADL17	30,00
Ducati Streetfighter V2	ADLSV2	30,00
Honda CBR1000RR-R Fireblade (2020/>)	ADLH19	30,00
Honda CBR 1000 RR (2008/2016)	ADL19	30,00
Honda CBR 600 RR	ADL19	30,00
Kawasaki ZX-10R (2011/>)	ADLZX	26,00
Kawasaki Ninja 400	ADLRR	20,00
MV Agusta F3 675/800	ADL18	30,00
MV Agusta F4	ADL16	30,00
MV Agusta Brutale 675/800	ADL14	30,00
Suzuki GSX-R 1000 (2017/>)	ADLRR	20,00
Triumph Speed Triple 1200 RS	ADL660	20,00
Triumph Speed Triple 1200 RR	ADLST	26,00
Triumph Street Triple 765 R/RS/RS Moto2 (2023/>)	ADL765	20,00
Yamaha YZF R1 (1998/>)	ADLY	26,00
Yamaha YZF R3 (2015/>)	ADLY	26,00
Yamaha YZF R6 (2006/>)	ADLY	26,00
Yamaha YZF R7 (2021/>)	ADLY	26,00
Yamaha MT-09 (2021/>)	ADLY	26,00



HANDLEBARS - SEMIMANUBRI

Tube for unlifted handlebars

Tubo per semimanubrio non rialzato

Tube length - Lunghezza tubo	245 mm
Tube useful length - Lunghezza utilizzabile tubo	225 mm
Outer tube diameter - Diametro esterno tubo	22 mm
Inner tube diameter - Diametro interno tubo	16 mm

Tube for lifted handlebars

Tubo per semimanubrio rialzato

Tube length - Lunghezza tubo	270 mm
Tube useful length - Lunghezza utilizzabile tubo	235 mm
Outer tube diameter - Diametro esterno tubo	22 mm
Inner tube diameter - Diametro interno tubo	16 mm

UNLIFTED HANDLEBARS
SEMIMANUBRI NON RIALZATI



LIFTED HANDLEBARS
SEMIMANUBRI RIALZATI



WARNING - ATTENZIONE

At the time of purchase it is necessary to choose the ideal diameter, first make sure of the diameter of the front forks of the bike and then choose the right diameter of the handlebars.

Al momento dell'acquisto occorre scegliere il diametro ideale, per prima cosa assicurarsi del diametro forcelle anteriori della moto e successivamente scegliere il giusto diametro dei semimanubri.

Bonamici Racing realizes for the major sports bikes, handlebars that allow a sporty driving at the highest levels and a perfect feeling in all conditions.

Two version: raised and not raised, both with inclination of 6.5° degrees. Each element of the Bonamici Racing handlebars is made from solid billet aluminium machined with cnc technology.

Bonamici Racing realizza per le maggiori moto sportive semimanubri che consentono una guida sportiva ai massimi livelli e un feeling perfetto in ogni condizione.

Varie versioni, rialzati e non rialzati, entrambi con inclinazione di 6,5° gradi. Ogni elemento del semimanubrio Bonamici Racing è realizzato dal pieno in alluminio billet lavorato con tecnologia cnc



BMW S 1000 RR (2023)
lifted handlebars / Diameter 55 mm - cod. SM55S1KW

HANDLEBARS - SEMIMANUBRI

DESCRIPTION DESCRIZIONE	OFFSET	HEIGHT RIALZO	SPARE TUBE TUBO DI RICAMBIO	CODE CODICE
Diameter 41 mm lifted - Diametro 41 mm rialzati	45 mm	15,5mm	RASM_1	SM41
Diameter 41 mm lifted 28mm - Diametro 41 mm rialzato 28 mm	45 mm	28 mm	RASM_1	SM41_30
Diameter 47 mm lifted - Diametro 47 mm rialzati	49 mm	15,5 mm	RASM_1	SM47
Diameter 48 mm lifted - Diametro 48 mm rialzati	49 mm	15,5 mm	RASM_1	SM48
Diameter 50 mm lifted - Diametro 50 mm rialzati	49 mm	15,5 mm	RASM_1	SM50
Diameter 50 mm lifted - Diametro 50 mm rialzati	18 mm	26 mm	RASM_2	SM50A
Diameter 50 mm unlifted - Diametro 50 mm non rialzati	16 mm	0 mm	RASM_2	SM50B
Diameter 51 mm lifted - Diametro 51 mm rialzati	49 mm	15,5 mm	RASM_1	SM51
Diameter 51 mm lifted - Diametro 51 mm rialzati (Aprilia RS 660) ⁴ (Aprilia RSV4 2021)	18 mm	26 mm	RASM_2	SM51A
Diameter 51 mm unlifted - Diametro 51 mm non rialzati	16 mm	0 mm	RASM_2	SM51B
Diameter 52 mm lifted - Diametro 52 mm rialzati	51,5 mm	15,5 mm	RASM_1	SM52
Diameter 52 mm unlifted - Diametro 52 mm non rialzati	16 mm	0 mm	RASM_2	SM52B
Diameter 53 mm lifted - Diametro 53 mm rialzati	51,5 mm	15,5 mm	RASM_1	SM53
Diameter 53 mm unlifted - Diametro 53 mm non rialzati	16 mm	0 mm	RASM_2	SM53B
Diameter 53 mm unlifted - Diametro 53 mm non rialzati (Ducati 1199S Panigale) ¹	16 mm	0 mm	RASM_2	SM53PA
Diameter 53 mm unlifted - Diametro 53 mm non rialzati (Panigale V2) ¹	40 mm	0 mm	RASM_2	SM53PV2
Diameter 53 mm unlifted - Diametro 53 mm non rialzati (Ducati Panigale V4/V4S) ¹	40mm	0 mm	RASM_2	SM53PV4
Diameter 53 mm unlifted - Diametro 53 mm non rialzati (Ducati Panigale V4R) ¹	40 mm	0 mm	RASM_2	SM53PV4R
Diameter 55 mm lifted - Diametro 55 mm rialzati	51,5 mm	15,5 mm	RASM_1	SM55
Diameter 55 mm unlifted - Diametro 55 mm non rialzati	18 mm	0 mm	RASM_2	SM55B
Diameter 55 mm lifted - Diametro 55 mm rialzati ² (BMW S 1000 RR / M 1000 RR '19/>)	18 mm	27 mm	RASM_2	SM55S1K
Diameter 55 mm lifted - Diametro 55 mm rialzati ³ (BMW S 1000 RR / M 1000 RR '19/>)	18 mm	27 mm	RASM_2	SM55S1KW
Diameter 55 mm unlifted - Diametro 55 mm non rialzati ² (BMW S 1000 RR / M 1000 RR '19/>)	18 mm	0 mm	RASM_2	SM55BS1K
Steering stops - Coppia battute di sterzo				BS02



Diameter 53 mm unlifted
Diametro 53 mm (Ducati Panigale V4/V4S)- cod. SM53PV4



Diameter 55 mm lifted
Diametro 55 mm (BMW S 1000 RR '19/>) - cod. SM55S1K

HANDLEBARS SPARE PARTS - RICAMBI SEMIMANUBRI

DESCRIPTION - DESCRIZIONE	CODE - CODICE
Clamps for OEM steering plate (BMW S 1000 RR - M 1000 RR '19 / >) Coppia di supporti ad arco per piastra di sterzo originale (BMW S 1000 RR - M 1000 RR '19 / >)	BMRS1K
Pair of balancers for SM55S1K/SM55B - Coppia contrappesi per SM55S1K/SM55B	ADLS1K_2
Spare bracket right side - Bracciale di ricambio lato DX	BMRD
Spare bracket left side - Bracciale di ricambio lato SX	BMRS
Spare tube for lifted handlebars (Tube length 270 mm - Tube useful length 235 mm) Tubo di ricambio per semimanubri rialzati (Lunghezza tubo 270 mm - Lunghezza utilizzabile 235mm)	RASM_1
Spare tube for unlifted handlebars (Tube length 245 mm - Tube useful length 225 mm) Tubo ricambio per semimanubri non rialzati (Lunghezza tubo 245 mm - Lunghezza utilizzabile 225mm)	RASM_2
Tube cap - Tappo tubo	TASM
Bracket for steering dumper - Bracciale ammortizzatore di sterzo	BAMS

WARNING - ATTENZIONE

- 1 • Include the bracket for steering dumper
• Include il bracciale per l'ammortizzatore di sterzo
- 2 • Handlebars to use the OEM triple clamp (include the clamps for steering plate) - Spare tube code RASM_2
• Semimanubri utilizzabili con la piastra di sterzo originale (Include la coppia di supporti ad arco per la piastra di sterzo)
Tubo di ricambio cod. RASM_2
- 3 • Handlebars to use with Bonamici Racing top triple clamp (not include the clamps for steering plate) - Spare tube code RASM_2
• Semimanubri utilizzabili con la piastra di sterzo Bonamici Racing (non include la coppia di supporti ad arco per la piastra di sterzo)
Tubo di ricambio cod. RASM_2
- 4 • We recommend purchasing the steering stops code - BS02
• Consigliamo l'acquisto delle battute di sterzo codice - BS02

MEASUREMENT SCHEME - SCHEMA MISURE

- Height means the distance between bracelet center / tube axis
- Offset means the distance between fork axis / tube axis
- Per Rialzo si intende la distanza tra centro bracciale / asse tubo
- Per Offset si intende la distanza tra asse forcella / asse tubo

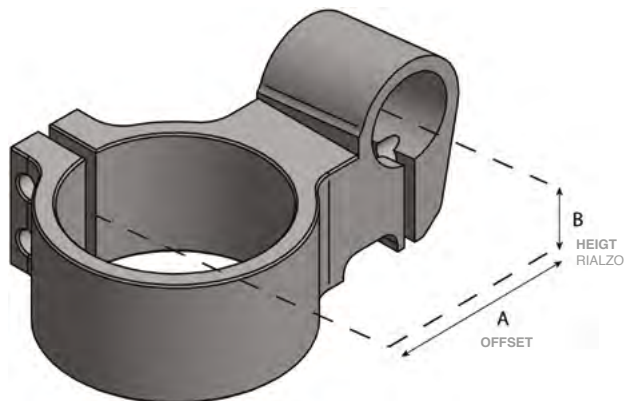

OFFSET

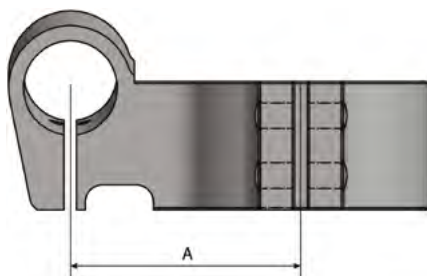

HEIGHT - RIALZO

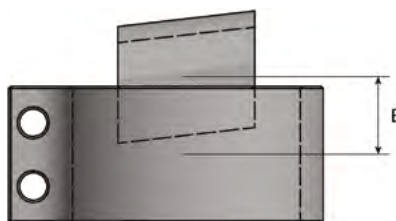

Ducati Panigale V4
Unlifted handlebars / Diameter 53 mm - cod. SM53PV4

CHAIN ADJUSTER - TENDICATENA



BRAND	MODEL - MODELLO	FROM - DAL	TO - AL	CODE - CODICE
Aprilia	RS 660 - Tuono 660 - Tuareg 660	2020	>	CHAD12
Aprilia	RSV4 / RSV4 Factory / Tuono V4	2021	>	CHAD13
Aprilia	RSV4 / Tuono V4	2015	2020	CHAD04
BMW	S 1000 RR	2008	2018	CHAD01
BMW	S 1000 RR	2019	>	CHAD09
BMW	S 1000 R	2012	2020	CHAD01
BMW	S 1000 R	2021	>	CHAD09
Honda	CBR 1000 RR	2008	2016	CHAD08
Honda	CBR 1000 RR Fireblade	2017	2019	CHAD05
Honda	CBR1000RR-R Fireblade	2020	>	CHAD10
Kawasaki	ZX-10R	2016	>	CHAD02
Suzuki	GSX-R 1000	2017	>	CHAD06
Suzuki	GSX-S 1000	2021	>	CHAD06
Yamaha	YZF R6	2017	>	CHAD07
Yamaha	YZF R1/MT-10	2015	2019	CHAD03
Yamaha	YZF R1	2020	>	CHAD11

Made of Ergal machined from solid with CNC technology, the Bonamici Racing chain adjuster is robust and effective, with the use of bearings to completely eliminate friction and for the first time with adjustable micrometric system. It is possible to customize the inner part in various colors, while the outer part is only available in black color

Realizzato in Ergal ricavato dal pieno con tecnologia CNC, il tendicatena Bonamici Racing è robusto ed efficace, con l'uso di cuscinetti per eliminare completamente l'attrito e le posizioni regolabili micrometricamente. È possibile la personalizzazione in vari colori per la parte interna, mentre la parte esterna è disponibile solo di colore nero



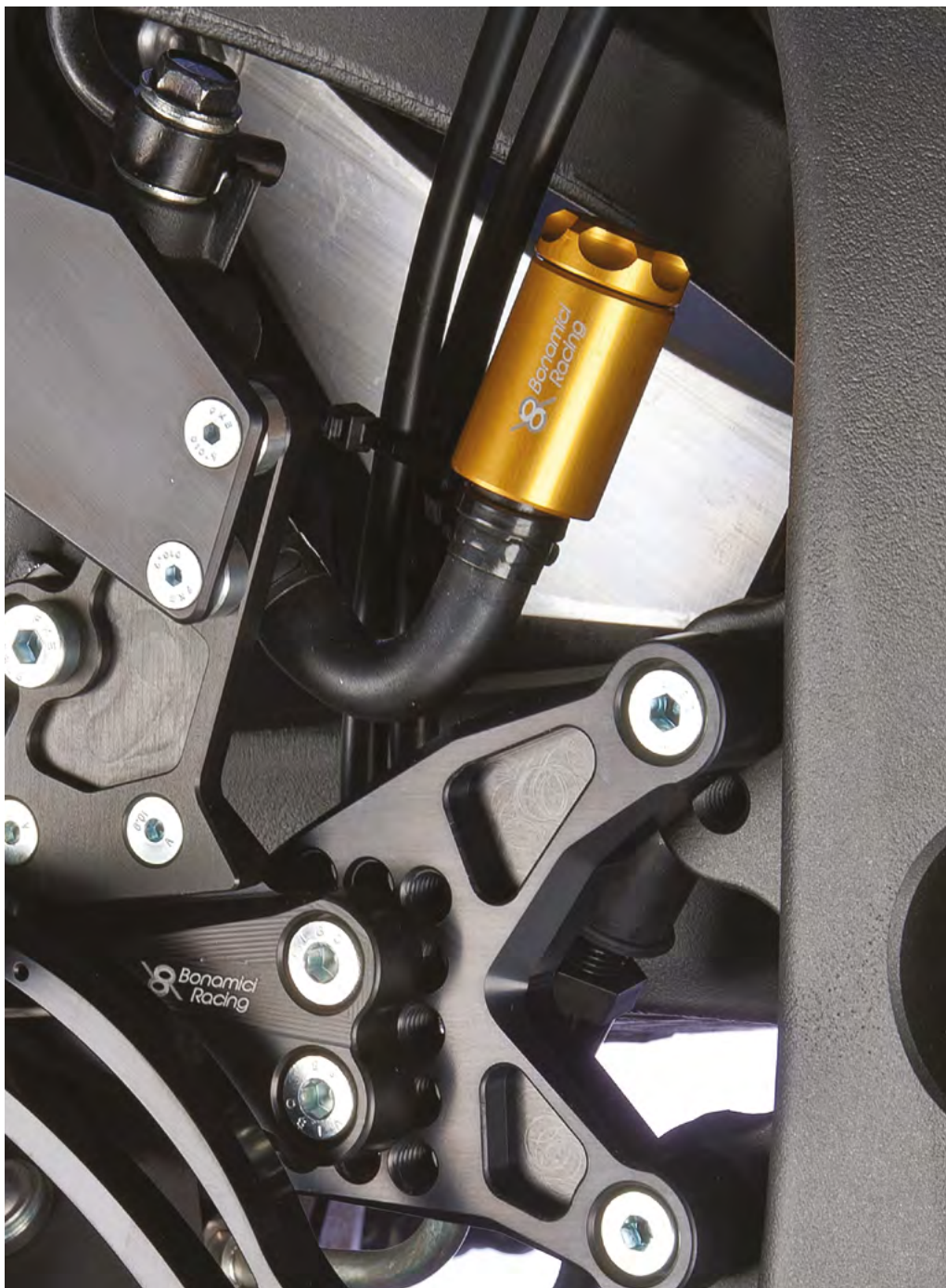

OIL TANK - SEBATOIO OLIO



DESCRIPTION - DESCRIZIONE

COLOUR- COLORE

CODE - CODICE

8 ml Rear oil tank Serbatoio olio posteriore 8 ml	black - blue - bronze - green gold - orange - red - silver	0040
Bracket tank - Supporto serbatoio	black	00S4

PRICES WITHOUT VAT - PREZZI IVA ESCLUSA



The new range of reservoirs is another novelties of Bonamici Racing. The 8ml version has been redesigned with a more modern design. All reservoirs are made with aluminum machined from solid and are available in various colors.

La nuova gamma di vasche olio è una delle novità della Bonamici Racing. La versione da 8ml è stata riprogettata con un design più moderno. I serbatoi sono in alluminio ricavati dal pieno e sono disponibili in vari colori.

SWING ARMS SPOOLS - SUPPORTI CAVALLETTO



DESCRIPTION - DESCRIZIONE	COLOUR- COLORE	CODE - CODICE
standard 6 mm	black - blue - bronze - green gold - orange - red - silver	0025
standard 8 mm	black - blue - bronze - green gold - orange - red - silver	0026
Kawasaki 10 x 1,25	black - blue - bronze - green gold - orange - red - silver	0030
KTM 790/890 Duke 10 x 1,5	black - blue - bronze - green gold - orange - red - silver	0031
racing 6 mm	black	0027
racing 8 mm	black	0028

PRICES WITHOUT VAT - PREZZI IVA ESCLUSA



The rear stand supports, made in aluminum machined from solid, are available in the following sizes, 6mm, 8mm and 10x1.25, are available in various colors and the Racing version has a larger point of foothold.

I supporti posteriori per i cavalletti in alluminio ricavati dal pieno sono disponibili nelle misure da 6mm, da 8mm e da 10x1,25 in vari colori ed inoltre nella versione racing con una sede per l'attacco più ampia.



BLOCKS MIRROR - TAPPI SPECCHIO



Silver



Gold



Orange



Red



Blue



Black

BRAND	MODEL - MODELLO	COLOUR- COLORE	CODE - CODICE
BMW	S 1000 RR (2019/ >)	black - blue - gold orange - red - silver	BM07
BMW	M 1000 RR (2021/ 2022)	black - blue - gold orange - red - silver	BM07
Ducati	899/1199 Panigale	black - blue - gold orange - red - silver	BM01
Ducati	959/1299 Panigale	black - blue - gold orange - red - silver	BM03
Ducati	Panigale V2/V4/V4S	black - blue - gold orange - red - silver	BM06
Honda	CBR 1000 RR Fireblade/RR-R (2017/ >)	black - blue - gold orange - red - silver	BM05
Suzuki	GSX-R 1000 (2017/ >)	black - blue - gold orange - red - silver	BM04
Yamaha	YZF R3 (2015-2018)	black - blue - gold orange - red - silver	BM02
Yamaha	YZF R7 (2021/ >)	black - blue - gold orange - red - silver	BM08



BRAND	MODEL - MODELLO	THREAD - FILETTO	COLOUR- COLORE	CODE - CODICE
Aprilia	Tuareg 660	M18x1,5	black - blue - green gold - orange - red - silver	T010
Aprilia	RS 660	M20x1,5	black - blue - green gold - orange - red - silver	T011
BMW	-	M24 x 2	black - blue - green gold - orange - red - silver	T004
Ducati	universal*	M22 x 1,5	black - blue - green gold - orange - red - silver	T001
Ducati	Hypermotard 821	M20x2,5	black - blue - green gold - orange - red - silver	T008
Ducati	Monster 821/1100/1200	M20x2,5	black - blue - green gold - orange - red - silver	T008
Ducati	Streetfighter 848 Streetfighter V2	M20x2,5	black - blue - green gold - orange - red - silver	T008
Ducati	848/1098/1198	M19,5 x 2,5	black - blue - green gold - orange - red - silver	T003
Ducati	899/1199 Panigale	M19,5 x 2,5	black - blue - green gold - orange - red - silver	T003
Ducati	1299 Panigale/V2	M20x2,5	black - blue - green gold - orange - red - silver	T008
Honda	universal*	M19,5 x 2,5	black - blue - green gold - orange - red - silver	T003
Kawasaki	universal*	M30 x 1,5	black - blue - green gold - orange - red - silver	T002
Kawasaki	Ninja 250/400	M20x2,5	black - blue - green gold - orange - red - silver	T008
Kawasaki	Z650	M20x2,5	black - blue - green gold - orange - red - silver	T008
Kawasaki	Z800/900	M20x2,5	black - blue - green gold - orange - red - silver	T008
Kawasaki	Z1000 14/15	M20x2,5	black - blue - green gold - orange - red - silver	T008
Suzuki	universal*	M20 x 1,5	black - blue - green gold - orange - red - silver	T005
Triumph	universal*	M19,5x2,5	black - blue - green gold - orange - red - silver	T003
Triumph	Street Triple 765 R/RS Speed Triple 1200 RS/RR	M20x2,5	black - blue - green gold - orange - red - silver	T009
Yamaha	universal*	M27 x 3	black - blue - green gold - orange - red - silver	T007
Yamaha	MT-03	M19,5x2,5	black - blue - green gold - orange - red - silver	T003
Yamaha	MT-09 (2013-2020)	M20x2,5	black - blue - green gold - orange - red - silver	T008
Yamaha	MT-09 (2021->)	M27 x 3	black - blue - green gold - orange - red - silver	T007

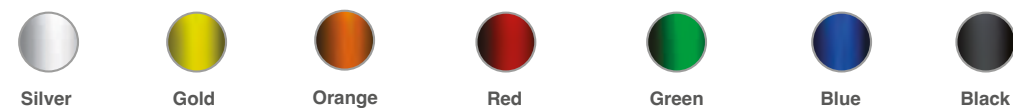

TANK CAPS - TAPPI SERBATOIO



Silver

Blue

Red

Orange

Gold

Green

Bronze



BRAND	MODEL - MODELLO	FROM - DAL	TO - AL	CODE - CODICE
APRILIA	RS 660 / TUONO 660	2020	>	FC090
APRILIA	RSV 1000 / RSV4 / TUONO / RSV4 Factory	2004	>	FC030
BMW	S 1000 R - S 1000 RR - M 1000RR - HP4	2008	>	FC040
DUCATI	748 / 916 / 996 / 998 / 848 / 1098	-	-	FC010
DUCATI	Panigale 899 / 1199 / 1299 / V2/ V4/ V4R	2012	>	FC050
DUCATI	Streetfighter / Scrambler 800	2009	>	FC050
HONDA	CB 500 F - CBR 500 R - CBR 650 R/F	2012	>	FC120
HONDA	CBR 600 RR	2003	>	FC160
HONDA	CBR 1000 RR	2004	2013	FC160
HONDA	CBR 1000 RR	2014	2016	FC150
HONDA	CBR 1000 RR Fireblade/RR-R	2017	>	FC120
KAWASAKI	Ninja 250/400	2018	>	FC170
KAWASAKI	ZX-6R	2007	2017	FC070
KAWASAKI	ZX-6R	2019	>	FC170
KAWASAKI	ZX-10R	2006	2020	FC070
KAWASAKI	ZX-10R	2021	>	FC170
KAWASAKI	ER-6N/Z 800/Z 1000	2007	2016	FC070
KAWASAKI	Z650/Z900	2017	2018	FC170
KTM	RC 390/Duke 390/Duke 790/890	2017	>	FC200
KTM	1290 Superduke	2014	>	FC210
MV AGUSTA	F3 675/800 - Brutale 675/800	2011	2018	FC090
MV AGUSTA	F4 - Brutale	1997	2009	FC190
MV AGUSTA	F4 - Brutale	2010	2019	FC130
SUZUKI	GSX-R 600/750	2004	2018	FC080
SUZUKI	GSX-R 1000	2003	>	FC080
SUZUKI	GSX-S 750	2015	>	FC080
SUZUKI	GSX-S 1000	2021	>	FC080
TRIUMPH	Street Triple (all M.Y.)	-	-	FC220
TRIUMPH	Daytona (all M.Y.)	-	-	FC220
TRIUMPH	Speed Triple (all M.Y.) *	-	-	FC220
YAMAHA	YZF R3	2015	>	FC110
YAMAHA	YZF R6	1999	>	FC110
YAMAHA	YZF R1/R1M	1998	>	FC110
YAMAHA	MT-03/MT-07/MT-09	-	-	FC110
YAMAHA	YZF R7	2021	>	FC110

* not compatible with the Speed Triple 1200 RS 2021/> and Speed Triple 1200 RR 2022/> models

* non compatibile con i modelli Speed Triple 1200 RS 2021/> e Speed Triple 1200 RR 2022/>

SPARE PART AND ACCESSORIES - ACCESSORI E RICAMBI

DESCRIPTION - DESCRIZIONE

CODE - CODICE

Center cap - Tappo centrale	FC00C
Extra colour (Center cap) Colore extra (parte interna)	FC00K



BONAMICI RACING CLOTHING - ABBIGLIAMENTO



DESCRIPTION - DESCRIZIONE

CODE - CODICE

SIZE - TAGLIA

T-SHIRT

TSH01

S - M - L - XL - XXL



DESCRIPTION - DESCRIZIONE

CODE - CODICE

Cap - Cappello

CAP01





BONAMICI RACING MERCHANDISING



DESCRIPTION - DESCRIZIONE

CODE - CODICE

Brake fluid reservoir sock cover
Polsino serbatoio Liquido Freno

PLS01



DESCRIPTION - DESCRIZIONE

CODE - CODICE

Rubber key ring Bonamici Racing Logo
Portachiavi in gomma Logo Bonamici Racing

KRG01





MODELS - MODELLI



MODELS MODELLI

INDEX MODELS - INDICE MODELLI

	APRILIA RSV4 (2021/>)	96
	APRILIA RSV4 (2017/2020)	97
	APRILIA RS 660 / TUONO 660 (2020/>)	98
	APRILIA TUAREG 660 (2021/>)	99
	BMW S 1000 RR (2017/2018)	100
	BMW S 1000 RR (2019/ 2022)	101
	BMW S 1000 RR (2023/>)	102
	BMW M 1000 RR (2021/>)	103
	BMW S 1000 R (2021/>)	104
	BMW S 1000 XR (2020/>)	105
	DUCATI 899/959/1199/1299 PANIGALE	106
	DUCATI PANIGALE V2	107
	DUCATI PANIGALE V4/V4S/V4R	108
	DUCATI STREETFIGHTER V2	109
	DUCATI STREETFIGHTER V4/V4S	110
	HONDA CBR 1000 RR FIREBLADE (2017/2019)	111
	HONDA CBR 1000 RR-R FIREBLADE (2020/>)	112
	KAWASAKI ZX-10R (2016/2020)	113
	KAWASAKI ZX-10R (2021/>)	114
	KAWASAKI NINJA 400	115
	KAWASAKI Z650	116
	KAWASAKI Z900	117
	KTM RC390 (2014/>)	118
	KTM 790/890 DUKE	119
	KTM 1290 SUPERDUKE R (2020/>)	120
	KTM 1290 SUPERDUKE (2017/2019)	121
	SUZUKI GSX-R 1000 (2017/>)	122
	SUZUKI GSX-S 1000 (2021/>)	123
	TRIUMPH STREET TRIPLE (2017/2022)	124
NEW	TRIUMPH STREET TRIPLE 765 R (2023/>)	125
NEW	TRIUMPH STREET TRIPLE 765 RS/MOTO 2 EDITION (2023/>)	126
	TRIUMPH SPEED TRIPLE (2011/2020)	127
	TRIUMPH SPEED TRIPLE 1200 RS (2021/>)	128
	TRIUMPH SPEED TRIPLE 1200 RR (2022/>)	129
	YAMAHA YZF R1 (2015/2019)	130
	YAMAHA YZF R1 (2020/>)	131
	YAMAHA YZF R6 (2017/>)	132
	YAMAHA YZF R7 (2021/>)	133
	YAMAHA YZF R3	134
NEW	YAMAHA MT-09	135
	YAMAHA MT-10	136



DESCRIPTION - DESCRIZIONE

CODE - CODICE

Rearset (normal shifting) - Pedane (cambio normale)	A005S
Rearset (reverse shifting) - Pedane (cambio rovesciato)	A005SR
Engine protections - Protezioni motore	CP107
Dashboard protection - Protezione strumentazione	DCP13
Lifted handlebars - Semimanubri rialzati	SM51A
Top triple clamp "Street" - Piastra di sterzo superiore "Street"	PSA1
Top triple clamp "Race" - Piastra di sterzo superiore "Race"	PSA1R
Brake lever - Leva freno	LB110
Brake lever with remote adjuster - Leva freno con registro a sx	RALB110
Clutch lever - Leva frizione	LC010
Full clutch lever - Leva frizione completa	LCF
Adjustable full clutch lever - Leva frizione completa regolabile	LCFR
Levers kit - Kit leve	KL010
Lever protection brake side - Protezione leva lato freno	LPRR
Carbon lever protection - Protezione leva in carbonio	LPLITE_R
Tank cap - Tappo serbatoio	FC030
8ml Oil tank - Serbatoio olio 8ml	0040
Chain adjuster - Tencicatena	CHAD13
Swing arms spools - Supporti cavalletto	0025
Swing arms spools "racing" - Supporti cavalletto "racing"	0027



DESCRIPTION - DESCRIZIONE

CODE - CODICE

Rearset (normal shifting) - Pedane (cambio normale)	A005S
Rearset (reverse shifting) - Pedane (cambio rovesciato)	A005SR
Engine protections - Protezioni motore	CP003
Dashboard protection - Protezione strumentazione	DCP06
Unlifted handlebars - Semimanubri bassi	SM51B
Lifted handlebars - Semimanubri rialzati	SM51
Top triple clamp "Street" - Piastra di sterzo superiore "Street"	PSA1
Top triple clamp "Race" - Piastra di sterzo superiore "Race"	PSA1R
Brake lever - Leva freno	LB110
Brake lever with remote adjuster - Leva freno con registro a sx	RALB110
Clutch lever - Leva frizione	LC010
Full clutch lever - Leva frizione completa	LCF
Adjustable full clutch lever - Leva frizione completa regolabile	LCFR
Levers kit - Kit leve	KL010
Lever protection brake side - Protezione leva lato freno	LPRR
Carbon lever protection - Protezione leva in carbonio	LPLITE_R
Tank cap - Tappo serbatoio	FC030
8ml Oil tank - Serbatoio olio 8ml	0040
Chain adjuster - Tendicatena	CHAD04
Swing arms spools - Supporti cavalletto	0025
Swing arms spools "racing" - Supporti cavalletto "racing"	0027



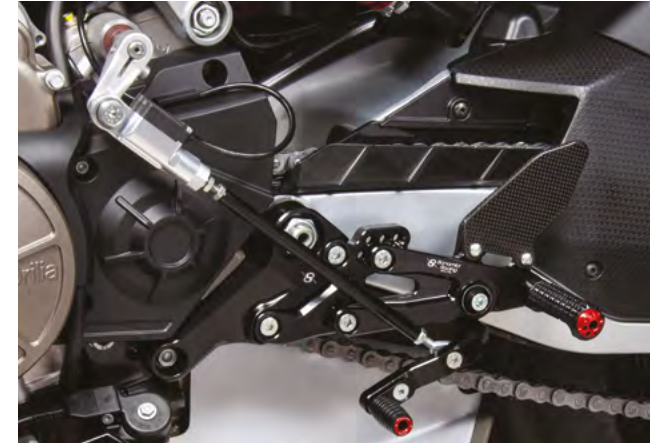

DESCRIPTION - DESCRIZIONE

CODE - CODICE

Rearset - Pedane	A006
Dashboard protection - Protezione strumentazione	DCP12
Lifted handlebars (only for RS 660) - Semimanubri rialzati (solo per RS 660)	SM51A
Steering stops - Coppia battute di sterzo	BS02
Top triple clamp (only for RS 660) - Piastra di sterzo superiore (solo per RS 660)	PSA2
Engine protections - Protezioni motore	CP114
Brake lever - Leva freno	LB110
Brake lever with remote adjuster - Leva freno con registro a sx	RALB110
Clutch lever - Leva frizione	LC010
Full clutch lever - Leva frizione completa	LCF
Adjustable full clutch lever - Leva frizione completa regolabile	LCFR
Levers kit - Kit leve	KL010
Racing remote adjuster - Registro remoto racing	RRP_BR
Remote adjuster - Registro remoto	00BR
Lever protection brake side - Protezione leva lato freno	LPRR
Lever protection clutch side - Protezione leva lato frizione	LPRL
Carbon lever protection - Protezione leva in carbonio	LPLITE_R
Tank cap - Tappo serbatoio	FC090
8ml Oil tank - Serbatoio olio 8ml	0040
Chain adjuster - Tendicatena	CHAD12
Swing arms spools "racing" - Supporti cavalletto "racing"	0027
Oil cap - Tappo olio	T011

**DESCRIPTION - DESCRIZIONE****CODE - CODICE**

Foot-peg Insert (LH/RH) + Brake side Toe pegs Inserti poggiapiedi + puntalino lato freno	A007
Engine protections - Protezioni motore	CP114
Dashboard protection - Protezione strumentazione	DCP13
Brake lever - Leva freno	LB230
Clutch lever - Leva frizione	LC010
Levers kit - Kit leve	KL370
Chain adjuster - Tendicatena	CHAD12
Oil cap - Tappo olio	T010
Swing arms spools - Supporti cavalletto	0025
Swing arms spools "racing" - Supporti cavalletto "racing"	0027





DESCRIPTION - DESCRIZIONE

CODE - CODICE

Rearset - Pedane	B005
Top triple clamp "Street" - Piastra di sterzo superiore "Street"	PSB1
Top triple clamp "Race" - Piastra di sterzo superiore "Race"	PSB1R
Unlifted handlebars - Semimanubri bassi	SM55B
Lifted handlebars - Semimanubri rialzati	SM55
Brake lever - Leva freno	LB090
Brake lever with remote adjuster - Leva freno con registro a sx	RALB090
Clutch lever - Leva frizione	LC140
Full clutch lever - Leva frizione completa	LCF
Adjustable full clutch lever - Leva frizione completa regolabile	LCFR
Levers kit - Kit leve	KL220
Lever protection - Protezione leva	LPRR
Carbon lever protection - Protezione leva in carbonio	LPLITE_R
Tank cap - Tappo serbatoio	FC040
8ml Oil tank - Serbatoio olio 8ml	0040
Chain adjuster - Tendicatena	CHAD01
Swing arms spools - Supporti cavalletto	0026
Swing arms spools "racing" - Supporti cavalletto "racing"	0028
Oil cap - Tappo olio	T004

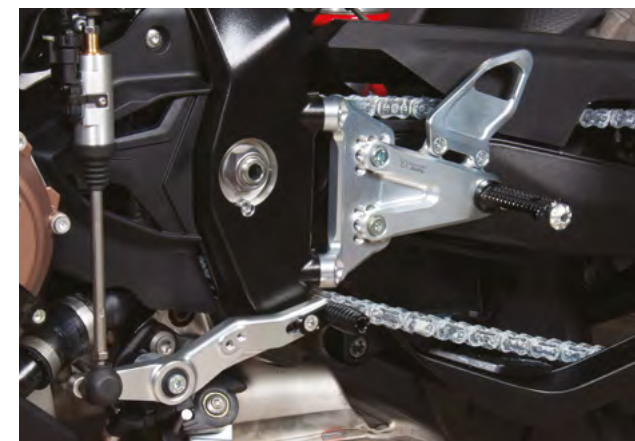

DESCRIPTION - DESCRIZIONE

CODE - CODICE

Rearset - Pedane	B007
Top triple clamp "Street"- Piastra di sterzo superiore "Street"	PSB2
Top triple clamp "Race" - Piastra di sterzo superiore "Race"	PSB2R
Engine protections "racing" 5 pcs. - Protezioni motore "racing" 5pz.	CP086B
Lifted handlebars* - Semimanubri rialzati*	SM55S1K
Lifted handlebars** - Semimanubri rialzati**	SM55S1KW
Brake lever*** - Leva freno***	LB090
Brake lever with remote adjuster - Leva freno con registro a sx	RALB090
Clutch lever*** - Leva frizione***	LC170
Full clutch lever - Leva frizione completa	LCF
Adjustable full clutch lever - Leva frizione completa regolabile	LCFR
Levers kit*** - Kit leve***	KL290
Lever protection - Protezione leva	LPRR
Carbon lever protection - Protezione leva in carbonio	LPLITE_R
Dashboard protection - Protezione strumentazione	DCP08
Tank cap - Tappo serbatoio	FC040
8ml Oil tank - Serbatoio olio 8ml	0040
Oil cap - Tappo olio	T004
Chain adjuster - Tendicatena	CHAD09
Swing arms spools "racing" - Supporti cavalletto "racing"	0028
Block mirror - Tappi specchio	BM07
Gear spacer support - Supporto distanziale cambio	DC_039B



* Handlebars to use the OEM triple clamp (include the steering plate bracelets)

* Semimanubri utilizzabili con la piastra di sterzo originale (Include i bracciali per la piastra di sterzo)

** Handlebars to use with Bonamici Racing top triple clamp (not include the clamps for steering plate)

** Semimanubri utilizzabili con la piastra di sterzo Bonamici Racing (non Include la coppia di supporti ad arco per la piastra di sterzo)

*** The brake lever may touch with the knob on the instrument frame, when the motorcycle is understeer.

The plastic protection cannot be remounted on the clutch lever.

*** La leva freno quando la moto è sottosterzo, potrebbe toccare con il pomello sul telaio porta strumentazione.

Non è possibile rimontare la protezione in plastica sulla leva frizione.



* Handlebars to use the OEM triple clamp (include the steering plate bracelets)

* Semimanubri utilizzabili con la piastra di sterzo originale (Include i bracciali per la piastra di sterzo)

** Handlebars to use with Bonamici Racing top triple clamp (not include the clamps for steering plate)

** Semimanubri utilizzabili con la piastra di sterzo Bonamici Racing (non include la coppia di supporti ad arco per la piastra di sterzo)

*** The brake lever may touch with the knob on the instrument frame, when the motorcycle is understeer.

The plastic protection cannot be remounted on the clutch lever.

*** La leva freno quando la moto è sottosterzo, potrebbe toccare con il pomello sul telaio porta strumentazione.

Non è possibile rimontare la protezione in plastica sulla leva frizione.

DESCRIPTION - DESCRIZIONE

CODE - CODICE

Rearset - Pedane	B007
Top triple clamp "Street"- Piastra di sterzo superiore "Street"	PSB3
Top triple clamp "Race" - Piastra di sterzo superiore "Race"	PSB3R
Engine protections "racing" 5 pcs. - Protezioni motore "racing" 5pz.	CP086B
Lifted handlebars* - Semimanubri rialzati*	SM55S1K
Lifted handlebars** - Semimanubri rialzati**	SM55S1KW
Brake lever*** - Leva freno***	LB090
Brake lever with remote adjuster - Leva freno con registro a sx	RALB090
Clutch lever*** - Leva frizione***	LC170
Full clutch lever - Leva frizione completa	LCF
Adjustable full clutch lever - Leva frizione completa regolabile	LCFR
Levers kit*** - Kit leve***	KL290
Lever protection - Protezione leva	LPRR
Carbon lever protection - Protezione leva in carbonio	LPLITE_R
Dashboard protection - Protezione strumentazione	DCP08
Tank cap - Tappo serbatoio	FC040
8ml Oil tank - Serbatoio olio 8ml	0040
Oil cap - Tappo olio	T004
Chain adjuster - Tendicatena	CHAD09
Swing arms spools "racing" - Supporti cavalletto "racing"	0028
Block mirror - Tappi specchio	BM07
Gear spacer support - Supporto distanziale cambio	DC_039B

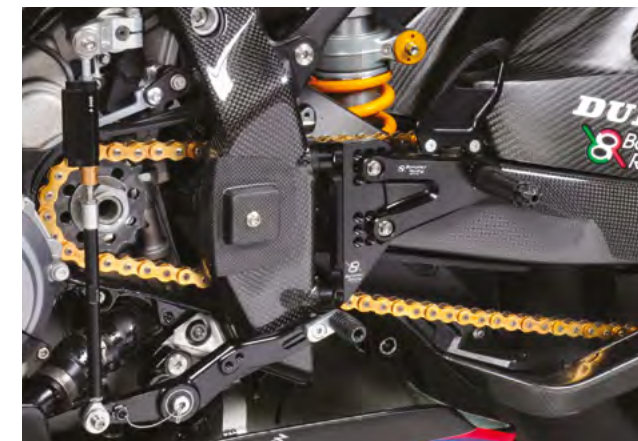

DESCRIPTION - DESCRIZIONE

CODE - CODICE

Rearset - Pedane	B007
Top triple clamp "Street"- Piastra di sterzo superiore "Street"	PSB3
Top triple clamp "Race" - Piastra di sterzo superiore "Race"	PSB3R
Engine protections "racing" 5 pcs. - Protezioni motore "racing" 5pz.	CP086B
Lifted handlebars* - Semimanubri rialzati*	SM55S1K
Lifted handlebars** - Semimanubri rialzati**	SM55S1KW
Brake lever*** - Leva freno***	LB090
Brake lever with remote adjuster - Leva freno con registro a sx	RALB090
Clutch lever*** - Leva frizione***	LC170
Full clutch lever - Leva frizione completa	LCF
Adjustable full clutch lever - Leva frizione completa regolabile	LCFR
Levers kit*** - Kit leve***	KL290
Lever protection - Protezione leva	LPRR
Carbon lever protection - Protezione leva in carbonio	LPLITE_R
Dashboard protection - Protezione strumentazione (2021-2022 models)	DCP08
Tank cap - Tappo serbatoio	FC040
8ml Oil tank - Serbatoio olio 8ml	0040
Oil cap - Tappo olio	T004
Swing arms spools "racing" - Supporti cavalletto "racing"	0028
Block mirror - Tappi specchio (2021-2022 models)	BM07
Gear spacer support - Supporto distanziale cambio	DC_039B



* Handlebars to use the OEM triple clamp (include the steering plate brackets)

** Semimanubri utilizzabili con la piastra di sterzo originale (Include i bracciali per la piastra di sterzo)

*** Handlebars to use with Bonamici Racing top triple clamp (not include the clamps for steering plate)

** Semimanubri utilizzabili con la piastra di sterzo Bonamici Racing (non include la coppia di supporti ad arco per la piastra di sterzo)

*** The brake lever may touch with the knob on the instrument frame, when the motorcycle is understeer.

The plastic protection cannot be remounted on the clutch lever.

*** La leva freno quando la moto è sottosterzo, potrebbe toccare con il pomello sul telaio porta strumentazione.

Non è possibile rimontare la protezione in plastica sulla leva frizione.



DESCRIPTION - DESCRIZIONE

CODE - CODICE

Rearset - Pedane	B008
Engine protections "racing" 5 pcs. - Protezioni motore "racing" 5pz.	CP086B
Brake lever - Leva freno	LB200
Brake lever with remote adjuster - Leva freno con registro a sx	RALB200
Clutch lever - Leva frizione	LC170
Full clutch lever - Leva frizione completa	LCF
Adjustable full clutch lever - Leva frizione completa regolabile	LCFR
Levers kit - Kit leve	KL270
Lever protection - Protezione leva	LPRR10
Dashboard protection - Protezione strumentazione	DCP08
Tank cap - Tappo serbatoio	FC040
8ml Oil tank - Serbatoio olio 8ml	0040
Oil cap - Tappo olio	T004
Chain adjuster - Tendicatena	CHAD09
Swing arms spools - Supporti cavalletto	0026
Swing arms spools "racing" - Supporti cavalletto "racing"	0028
Gear spacer support - Supporto distanziale cambio	DC_039B

**DESCRIPTION - DESCRIZIONE**

DESCRIPTION - DESCRIZIONE	CODE - CODICE
Rearset - Pedane	B009
Engine protections 4pcs. - Protezioni motore 4pz.	CP116
Brake lever - Leva freno	LB200
Clutch lever - Leva frizione	LC170
Levers kit - Kit leve	KL270
Dashboard protection - Protezione strumentazione	DCP08
Oil cap - Tappo olio	T004



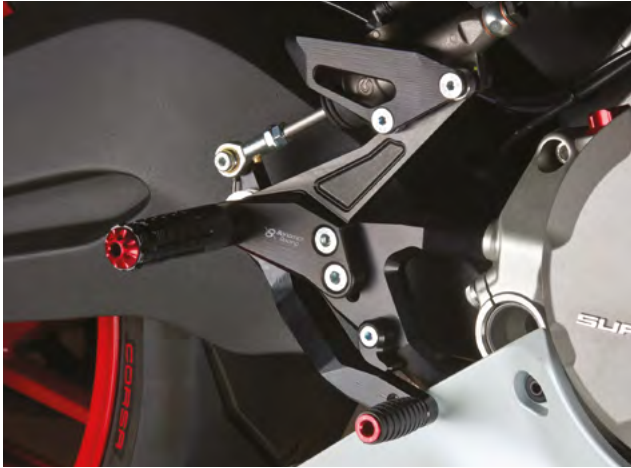

DESCRIPTION - DESCRIZIONE

CODE - CODICE

Rearset - Pedane	DV2
Engine protections (for 959) - Protezioni motore (per 959)	CP009B
Unlifted handlebars ø53mm - Semimanubri bassi ø53mm	SM53B
Unlifted handlebars for 1199S - Semimanubri bassi per 1199S	SM53PA
Lifted handlebars ø53mm - Semimanubri rialzati ø53mm	SM53
Brake lever - Leva freno	LB140
Brake lever with remote adjuster - Leva freno con registro a sx	RALB140
Clutch lever - Leva frizione	LC061
Levers kit - Kit leve	KL031
Lever protection - Protezione leva	LPRR
Carbon lever protection - Protezione leva in carbonio	LPLITE_R
Tank cap - Tappo serbatoio	FC050
Oil cap (899/1199) - Tappo olio (899/1199)	T003
Oil cap (1299) - Tappo olio (1299)	T008
8ml Oil tank - Serbatoio olio 8ml	0040
Block mirror (899/1199) - Tappi specchio (899/1199)	BM01
Block mirror (959/1299) - Tappi specchio (959/1299)	BM03

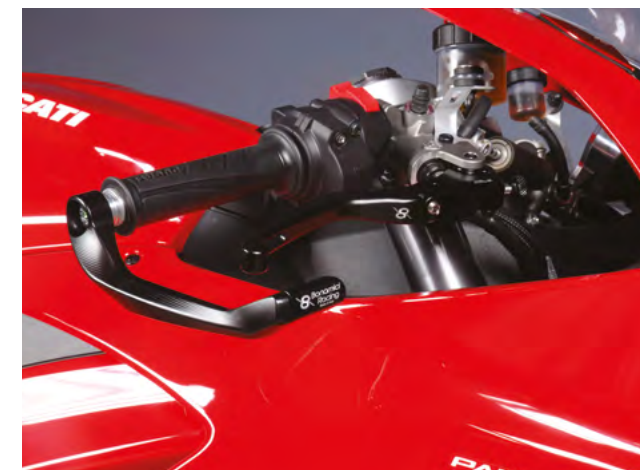

DESCRIPTION - DESCRIZIONE

CODE - CODICE

Rearset - Pedane	DV2
Engine protections - Protezioni motore	CP105
Handlebars with steering dumper bracket Semimanubri con bracciale per ammortizzatore di sterzo	SM53PV2
Top triple clamp - Piastra di sterzo superiore	PSV2
Dashboard protection - Protezione strumentazione	DCP11
Brake lever - Leva freno	LB140
Brake lever with remote adjuster - Leva freno con registro a sx	RALB140
Clutch lever - Leva frizione	LC061
Levers kit - Kit leve	KL031
Lever protection - Protezione leva	LPRR
Carbon lever protection - Protezione leva in carbonio	LPLITE_R
Tank cap - Tappo serbatoio	FC050
8ml Oil tank - Serbatoio olio 8ml	0040
Oil cap - Tappo olio	T008
Block mirror - Tappi specchio	BM06



DUCATI PANIGALE V4/V4S/V4R



DESCRIPTION - DESCRIZIONE

CODE - CODICE

Rearset - Pedane	DV4
Engine protections - Protezioni motore (V4/V4S)	CP081
Engine protections - Protezioni motore (V4R)	CP081B
Handlebars with steering dumper bracket (V4/V4S) Semimanubri con bracciale per ammortizzatore di sterzo (V4/V4S)	SM53PV4
Handlebars with steering dumper bracket (V4R) Semimanubri con bracciale per ammortizzatore di sterzo (V4R)	SM53PV4R
Top triple clamp - Piastra di sterzo superiore (V4/V4S 2018-> models) (V4R 2019-2022 models)	PSV4
Dashboard protection - Protezione strumentazione	DCP03
Brake lever - Leva freno (2018-2022 models)	LB140
Brake lever - Leva freno (2023- > models)	LB240
Brake lever with remote adjuster - Leva freno con registro a sx (2018 - 2022 models)	RALB140
Brake lever with remote adjuster - Leva freno con registro a sx (2023 - > models)	RALB240
Brake lever with racing remote adjuster - Leva freno con registro racing a sx (2018 - 2022 models)	RALB140R
Brake lever with racing remote adjuster - Leva freno con registro racing a sx (2023 - > models)	RALB240R
Clutch lever - Leva frizione	LC061
Levers kit - Kit leve (2018-2022 models)	KL031
Levers kit - Kit leve (2023- > models)	KL380
Lever protection - Protezione leva	LPRR
Carbon lever protection - Protezione leva in carbonio	LPLITE_R
Tank cap - Tappo serbatoio	FC050
8ml Oil tank - Serbatoio olio 8ml	0040
Oil cap - Tappo olio	T003
Block mirror - Tappi specchio	BM06



DESCRIPTION - DESCRIZIONE

CODE - CODICE

Rearset - Pedane	DSTR3
Dashboard protection - Protezione strumentazione	DCP11
Brake lever - Leva freno	LB240
Brake lever with remote adjuster - Leva freno con registro a sx	RALB240
Brake lever with racing remote adjuster - Leva freno con registro racing a sx	RALB240R
Clutch lever - Leva frizione	LC061
Levers kit - Kit leve	KL380
Lever protection - Protezione leva	LPRR
Carbon lever protection - Protezione leva in carbonio	LPLITE_R
Tank cap - Tappo serbatoio	FC050
8ml Oil tank - Serbatoio olio 8ml	0040
Oil cap - Tappo olio	T008



DUCATI STREETFIGHTER V4/V4S



DESCRIPTION - DESCRIZIONE

CODE - CODICE

Rearset - Pedane	DSTR2
Engine protections - Protezioni motore (2020-2022)	CP103
Engine protections - Protezioni motore (2023->)	CP081
Dashboard protection - Protezione strumentazione	DCP10
Brake lever - Leva freno	LB140
Brake lever with remote adjuster - Leva freno con registro a sx	RALB140
Clutch lever - Leva frizione	LC061
Levers kit - Kit leve	KL031
Lever protection - Protezione leva	LPRR
Carbon lever protection - Protezione leva in carbonio	LPLITE_R
Tank cap - Tappo serbatoio	FC050
8ml Oil tank - Serbatoio olio 8ml	0040
Oil cap - Tappo olio	T003



DESCRIPTION - DESCRIZIONE

CODE - CODICE

Rearset - Pedane	H013
Rearset (with QS) - Pedane (con quickshifter)	H014
Unlifted handlebars - Semimanubri bassi	SM50B
Lifted handlebars - Semimanubri rialzati	SM50
Top triple clamp "Street" - Piastra di sterzo superiore "Street"	PSH1
Top triple clamp "Race" - Piastra di sterzo superiore "Race"	PSH1R
Brake lever - Leva freno	LB150
Brake lever with remote adjuster - Leva freno con registro a sx	RALB150
Clutch lever - Leva frizione	LC020
Full clutch lever - Leva frizione completa	LCF
Adjustable full clutch lever - Leva frizione completa regolabile	LCFR
Levers kit - Kit leve	KL040
Lever protection - Protezione leva	LPRR
Carbon lever protection - Protezione leva in carbonio	LPLITE_R
Tank cap - Tappo serbatoio	FC120
Oil cap - Tappo olio	T003
8ml Oil tank - Serbatoio olio 8ml	0040
Chain adjuster - Tencicatena	CHAD05
Swing arms spools - Supporti cavalletto	0026
Swing arms spools "racing" - Supporti cavalletto "racing"	0028
Block mirror - Tappi specchio	BM05



HONDA CBR 1000 RR-R FIREBLADE 2020

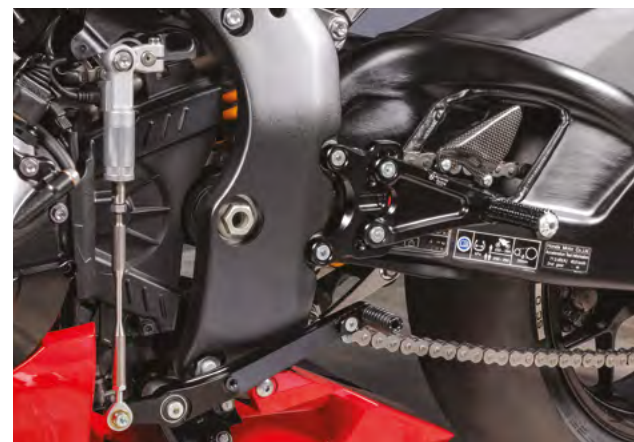
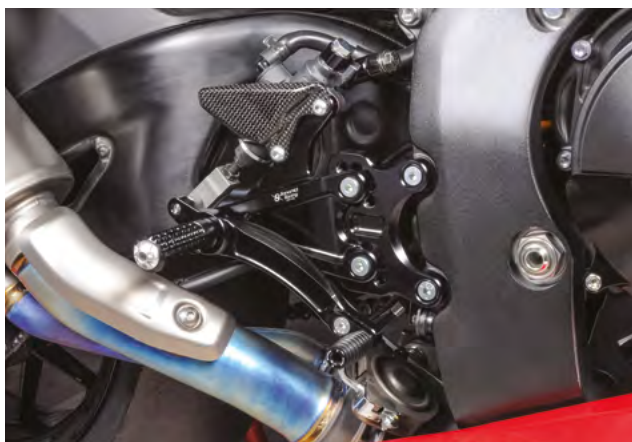

DESCRIPTION - DESCRIZIONE

CODE - CODICE

Rearset "Racing" - Pedane "Racing"	H015
Rearset "Standard" - Pedane "Standard"	H016

DESCRIPTION - DESCRIZIONE

CODE - CODICE

Gear spacer support - Supporto distanziale cambio	DC_040B
Engine protections - Protezioni motore	CP100
Unlifted handlebars - Semimanubri bassi	SM50B
Top triple clamp - Piastra di sterzo superiore	PSH2
Brake lever - Leva freno	LB150
Brake lever (for SP model) - Leva freno (per modello SP)	LB110
Brake lever with remote adjuster - Leva freno con registro a sx	RALB150
Brake lever with remote adj. (SP) - Leva freno con registro a sx (SP.)	RALB110
Clutch lever - Leva frizione	LC020
Full clutch lever - Leva frizione completa	LCF
Adjustable full clutch lever - Leva frizione completa regolabile	LCFR
Levers kit - Kit leve	KL040
Levers kit (for SP model) - Kit leve (per modello SP)	KL310
Lever protection - Protezione leva	LPRR
Carbon lever protection - Protezione leva in carbonio	LPLITE_R
Tank cap - Tappo serbatoio	FC120
Oil cap - Tappo olio	T003
8ml Oil tank - Serbatoio olio 8ml	0040
Chain adjuster - Tendicatena	CHAD10
Dashboard protection - Protezione strumentazione	DCP09
Swing arms spools - Supporti cavalletto	0026
Swing arms spools "racing" - Supporti cavalletto "racing"	0028
Block mirror - Tappi specchio	BM05



DESCRIPTION - DESCRIZIONE

CODE - CODICE

Rearset (normal shifting) - Pedane (cambio normale)	K015
Engine protections - Protezioni motore	CP012
Unlifted handlebars - Semimanubri bassi	SM50B
Lifted handlebars - Semimanubri rialzati	SM50
Top triple clamp "Street" - Piastra di sterzo superiore "Street"	PSK1
Top triple clamp "Race" - Piastra di sterzo superiore "Race"	PSK1R
Brake lever - Leva freno	LB110
Brake lever with remote adjuster - Leva freno con registro a sx	RALB110
Clutch lever - Leva frizione	LC040
Full clutch lever - Leva frizione completa	LCF
Adjustable full clutch lever - Leva frizione completa regolabile	LCFR
Levers kit - Kit leve	KL210
Lever protection - Protezione leva	LPRR
Carbon lever protection - Protezione leva in carbonio	LPLITE_R
Tank cap - Tappo serbatoio	FC070
Oil cap - Tappo olio	T002
8ml Oil tank - Serbatoio olio 8ml	0040
Chain adjuster - Tendicatena	CHAD02
Swing arms spools - Supporti cavalletto	0026
Swing arms spools "racing" - Supporti cavalletto "racing"	0028





DESCRIPTION - DESCRIZIONE

CODE - CODICE

Rearset - Pedane	K021
Engine protections - Protezioni motore	CP012
Unlifted handlebars - Semimanubri bassi	SM50B
Lifted handlebars - Semimanubri rialzati	SM50
Dashboard protection - Protezione strumentazione	DCP20
Top triple clamp "Street" - Piastra di sterzo superiore "Street"	PSK1
Top triple clamp "Race" - Piastra di sterzo superiore "Race"	PSK1R
Brake lever - Leva freno	LB110
Brake lever with remote adjuster - Leva freno con registro a sx	RALB110
Brake lever with Racing remote adjuster - Leva freno con registro Racing a sx	RALB110R
Clutch lever - Leva frizione	LC040
Full clutch lever - Leva frizione completa	LCF
Adjustable full clutch lever - Leva frizione completa regolabile	LCFR
Levers kit - Kit leve	KL210
Lever protection - Protezione leva	LPRR
Carbon lever protection - Protezione leva in carbonio	LPLITE_R
Tank cap - Tappo serbatoio	FC170
Oil cap - Tappo olio	T002
8ml Oil tank - Serbatoio olio 8ml	0040
Chain adjuster - Tencatena	CHAD02
Swing arms spools - Supporti cavalletto	0026
Swing arms spools "racing" - Supporti cavalletto "racing"	0028

KAWASAKI NINJA 250/400 2018/ >



DESCRIPTION - DESCRIZIONE

DESCRIPTION - DESCRIZIONE	CODE - CODICE
Rearset - Pedane	K019
28 mm lifted handlebars* - Semimanubri rialzati di 28 mm*	SM41_30
Brake lever - Leva freno	LB180
Brake lever with remote adjuster - Leva freno con registro a sx	RALB180
Clutch lever - Leva frizione	LC160
Full clutch lever - Leva frizione completa	LCF
Adjustable full clutch lever - Leva frizione completa regolabile	LCFR
Levers kit - Kit leve	KL260
Lever protection - Protezione leva	LPRR
Carbon lever protection - Protezione leva in carbonio	LPLITE_R
Tank cap - Tappo serbatoio	FC170
Oil cap - Tappo olio	T008
8ml Oil tank - Serbatoio olio 8ml	0040
Swing arms spools - Supporti cavalletto	0026
Swing arms spools "racing" - Supporti cavalletto "racing"	0028

*It need to modify the original fairing
*Occorre modificare le carene originali





DESCRIPTION - DESCRIZIONE

CODE - CODICE

Rearset - Pedane	K018
Full clutch lever - Leva frizione completa	LCF
Adjustable full clutch lever - Leva frizione completa regolabile	LCFR
Lever protection - Protezione leva	LPRR
Carbon lever protection - Protezione leva in carbonio	LPLITE_R
Tank cap - Tappo serbatoio	FC170
8ml Oil tank - Serbatoio olio 8ml	0040
Swing arm spools - Supporti cavalletto	0026
Swing arms spools "racing" - Supporti cavalletto "racing"	0028



DESCRIPTION - DESCRIZIONE

CODE - CODICE

Rearset - Pedane	K017
Full clutch lever - Leva frizione completa	LCF
Adjustable full clutch lever - Leva frizione completa regolabile	LCFR
Lever protection - Protezione leva	LPRR
Carbon lever protection - Protezione leva in carbonio	LPLITE_R
Tank cap - Tappo serbatoio	FC170
8ml Oil tank - Serbatoio olio 8ml	0040
Swing arm spools - Supporti cavalletto	0026
Swing arms spools "racing" - Supporti cavalletto "racing"	0028





DESCRIPTION - DESCRIZIONE

CODE - CODICE

Rearset - Pedane	KT01
Full clutch lever - Leva frizione completa	LCF
Adjustable full clutch lever - Leva frizione completa regolabile	LCFR
Lever protection - Protezione leva	LPRR
Carbon lever protection - Protezione leva in carbonio	LPLITE_R
Tank cap - Tappo serbatoio	FC200
8ml Oil tank - Serbatoio olio 8ml	0040
Swing arms spools - Supporti cavalletto	0026
Swing arms spools "racing" - Supporti cavalletto "racing"	0028

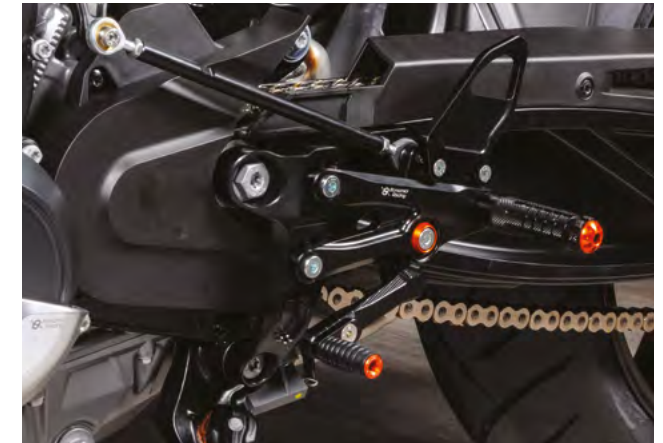

DESCRIPTION - DESCRIZIONE

CODE - CODICE

Rearset - Pedane	KT04
Engine protections - Protezioni motore (Duke 890)	CP093B
Levers kit - Kit leve	KL300
Brake lever - Leva freno	LB190
Clutch lever - Leva frizione	LC180
Lever protection brake side - Protezione leva DX	LPRR
Lever protection clutch side - Protezione leva SX	LPRL
Carbon lever protection - Protezione leva in carbonio	LPLITE_R
Tank cap - Tappo serbatoio	FC200
8ml Oil tank - Serbatoio olio 8ml	0040
Swing arm spools 10 x 1,5 - Supporti cavalletto 10 x 1,5	0031





DESCRIPTION - DESCRIZIONE

CODE - CODICE

Rearset - Pedane	KT05
Engine protections - Protezioni motore	CP060
Levers kit - Kit leve	KL280
Brake lever - Leva freno	LB110
Clutch lever - Leva frizione	LC200
Full clutch lever - Leva frizione completa	LCF
Adjustable full clutch lever - Leva frizione completa regolabile	LCFR
Lever protection - Protezione leva	LPRR
Carbon lever protection - Protezione leva in carbonio	LPLITE_R
Tank cap - Tappo serbatoio	FC210
8ml Oil tank - Serbatoio olio 8ml	0040

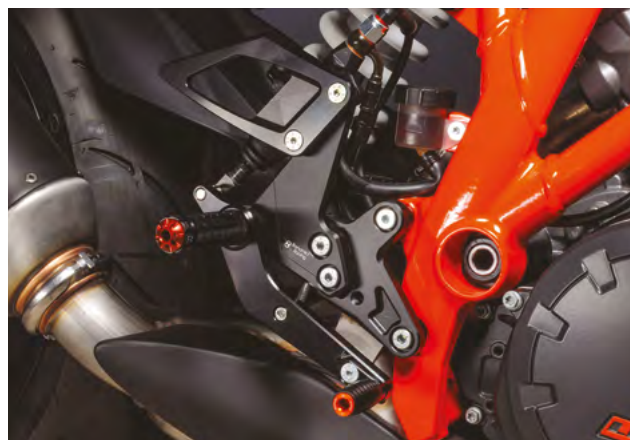

DESCRIPTION - DESCRIZIONE

CODE - CODICE

Rearset - Pedane	KT03
Engine protections - Protezioni motore	CP060
Full clutch lever - Leva frizione completa	LCF
Adjustable full clutch lever - Leva frizione completa regolabile	LCFR
Lever protection - Protezione leva	LPRR
Carbon lever protection - Protezione leva in carbonio	LPLITE_R
Tank cap - Tappo serbatoio	FC210
8ml Oil tank - Serbatoio olio 8ml	0040





DESCRIPTION - DESCRIZIONE

CODE - CODICE

Rearset - Pedane	S011
Engine protections - Protezioni motore	CP070
Unlifted handlebars - Semimanubri bassi	SM50B
Lifted handlebars - Semimanubri rialzati	SM50
Dashboard protection - Protezione strumentazione	DCP05
Top triple clamp "Street" - Piastra di sterzo superiore "Street"	PSS1
Top triple clamp "Race" - Piastra di sterzo superiore "Race"	PSS1R
Brake lever - Leva freno	LB090
Brake lever with remote adjuster - Leva freno con registro a sx	RALB090
Clutch lever - Leva frizione	LC090
Full clutch lever - Leva frizione completa	LCF
Adjustable full clutch lever - Leva frizione completa regolabile	LCFR
Levers kit - Kit leve	KL170
Lever protection - Protezione leva	LPRR
Carbon lever protection - Protezione leva in carbonio	LPLITE_R
Tank cap - Tappo serbatoio	FC080
Oil cap - Tappo olio	T005
8ml Oil tank - Serbatoio olio 8ml	0040
Chain adjuster - Tendicatena	CHAD06
Swing arms spools - Supporti cavalletto	0026
Swing arms spools "racing" - Supporti cavalletto "racing"	0028
Block mirror - Tappi specchio	BM04

**DESCRIPTION - DESCRIZIONE**

DESCRIPTION - DESCRIZIONE	CODE - CODICE
Brake lever - Leva freno	LB201
Brake lever with remote adjuster - Leva freno con registro a sx	RALB201
Clutch lever - Leva frizione	LC210
Levers kit - Kit leve	KL330
Lever protection (adaptor code ADL17) - Paraleva (adattatore codice ADL17)	LPRR
Carbon lever protection - Protezione leva in carbonio	LPLITE_R
Dashboard protection - Protezione strumentazione	DCP05
Tank cap - Tappo serbatoio	FC080
8ml Oil tank - Serbatoio olio 8ml	0040
Oil cap - Tappo olio	T005
Chain adjuster - Tendicatena	CHAD06
Swing arms spools - Supporti cavalletto	0026
Swing arms spools "racing" - Supporti cavalletto "racing"	0028





DESCRIPTION - DESCRIZIONE

CODE - CODICE

Rearset - Pedane	TH06
Engine protections - Protezioni motore	CP074
Full clutch lever - Leva frizione completa	LCF
Adjustable full clutch lever - Leva frizione completa regolabile	LCFR
Lever protection - Protezione leva	LPRR
Carbon lever protection - Protezione leva in carbonio	LPLITE_R
Tank cap - Tappo serbatoio	FC220
8ml Oil tank - Serbatoio olio 8ml	0040
Swing arm spools - Supporti cavalletto	0026
Swing arms spools "racing" - Supporti cavalletto "racing"	0028



DESCRIPTION - DESCRIZIONE

CODE - CODICE

Rearset - Pedane	TH09
Engine protections - Protezioni motore	CP074
Brake lever - Leva freno	LB200
Brake lever with remote adjuster - Leva freno con registro a sx	RALB200
Brake lever with Racing remote adjuster - Leva freno con registro Racing a sx	RALB200R
Clutch lever - Leva frizione	LC080
Full clutch lever - Leva frizione completa	LCF
Adjustable full clutch lever - Leva frizione completa regolabile	LCFR
Levers kit - Kit leve	KL390
Lever protection - Protezione leva (Adaptor/Adattatore - code ADL765)	LPRR
Carbon lever protection - Protezione leva in carbonio (Adaptor/Adattatore - code ADL765_C)	LPLITE_R
Oil cap - Tappo olio	T009
8ml Oil tank - Serbatoio olio 8ml	0040
Tank cap - Tappo serbatoio	FC220
Swing arms spools - Supporti cavalletto	0026
Swing arms spools "racing" - Supporti cavalletto "racing"	0028





DESCRIPTION - DESCRIZIONE

CODE - CODICE

Rearset - Pedane	TH09
Engine protections - Protezioni motore	CP074
Brake lever - Leva freno	LB210
Brake lever with remote adjuster - Leva freno con registro a sx	RALB210
Brake lever with Racing remote adjuster - Leva freno con registro Racing a sx	RALB210R
Clutch lever - Leva frizione	LC230
Full clutch lever - Leva frizione completa	LCF
Adjustable full clutch lever - Leva frizione completa regolabile	LCFR
Levers kit - Kit leve	KL360
Lever protection - Protezione leva (Adaptor/Adattatore - code ADL765)	LPRR
Carbon lever protection - Protezione leva in carbonio (Adaptor/Adattatore - code ADL765_C)	LPLITE_R
Oil cap - Tappo olio	T009
8ml Oil tank - Serbatoio olio 8ml	0040
Tank cap - Tappo serbatoio	FC220
Swing arms spools - Supporti cavalletto	0026
Swing arms spools "racing" - Supporti cavalletto "racing"	0028



DESCRIPTION - DESCRIZIONE

CODE - CODICE

Rearset (normal shifting) - Pedane (cambio normale)	TH05
Brake lever - Leva freno (for models from 2011 to 2017)	LB110
Brake lever with remote adjuster - Leva freno con registro a sx	RALB110
Clutch lever - Leva frizione (for models from 2011 to 2017)	LC080
Levers kit - Kit leve (for models from 2011 to 2017)	KL180
Full clutch lever - Leva frizione completa	LCF
Adjustable full clutch lever - Leva frizione completa regolabile	LCFR
Lever protection - Paraleva	LP RR
Carbon lever protection - Protezione leva in carbonio	LPLITE_R
Tank cap - Tappo serbatoio	FC220
8ml Oil tank - Serbatoio olio 8ml	0040
Oil cap - Tappo olio	T003





DESCRIPTION - DESCRIZIONE

CODE - CODICE

Rearset - Pedane	TH08
Engine protections - Protezioni motore	CP119
Brake lever - Leva freno	LB210
Brake lever with remote adjuster - Leva freno con registro a sx	RALB210
Brake lever with Racing remote adjuster - Leva freno con registro Racing a sx	RALB210R
Clutch lever - Leva frizione	LC230
Full clutch lever - Leva frizione completa	LCF
Adjustable full clutch lever - Leva frizione completa regolabile	LCFR
Levers kit - Kit leve	KL360
Lever protection - Protezione leva	LPRR
Carbon lever protection - Protezione leva in carbonio	LPLITE_R
Oil cap - Tappo olio	T009
8ml Oil tank - Serbatoio olio 8ml	0040



DESCRIPTION - DESCRIZIONE

CODE - CODICE

Rearset - Pedane	TH07
Engine protections - Protezioni motore	CP119
Top triple clamp - Piastra di sterzo superiore*	PST1
Brake lever - Leva freno	LB210
Brake lever with remote adjuster - Leva freno con registro a sx	RALB210
Brake lever with Racing remote adjuster - Leva freno con registro Racing a sx	RALB210R
Clutch lever - Leva frizione	LC230
Full clutch lever - Leva frizione completa	LCF
Adjustable full clutch lever - Leva frizione completa regolabile	LCFR
Levers kit - Kit leve	KL360
Lever protection - Paraleva	LPRR
Carbon lever protection - Protezione leva in carbonio	LPLITE_R
Oil cap - Tappo olio	T009
8ml Oil tank - Serbatoio olio 8ml	0040



(*) Equipped with Bonamici Racing Nut, when mounting it is recommended to apply a light layer of grease.

(*) Dotata del dado Bonamici Racing, si consiglia al momento del montaggio del dado di applicare un leggero strato di grasso



DESCRIPTION - DESCRIZIONE

CODE - CODICE

Rearset - Pedane	Y011
Bracket for Akrapovic exhaust - Staffa per scarico Akrapovic	SS_007A
Engine protections - Protezioni motore	CP047
Unlifted handlebars - Semimanubri bassi	SM50B
Top triple clamp "Street" - Piastra di sterzo superiore "Street"	PSY1
Top triple clamp "Race" - Piastra di sterzo superiore "Race"	PSY1R
Dashboard protection - Protezione strumentazione	DCP04
Brake lever - Leva freno	LB101
Clutch lever - Leva frizione	LC010
Full clutch lever - Leva frizione completa	LCF
Adjustable full clutch lever - Leva frizione completa regolabile	LCFR
Levers kit - Kit leve	KL231
Lever protection - Paraleva	LPRR
Carbon lever protection - Protezione leva in carbonio	LPLITE_R
Tank cap - Tappo serbatoio	FC110
Oil cap - Tappo olio	T007
8ml Oil tank - Serbatoio olio 8ml	0040
Chain adjuster - Tendicatena	CHAD03
Swing arms spools - Supporti cavalletto	0025
Swing arms spools "racing" - Supporti cavalletto "racing"	0027



DESCRIPTION - DESCRIZIONE

CODE - CODICE

Rearset - Pedane	Y011
Bracket for Akrapovic exhaust - Staffa per scarico Akrapovic	SS_007A
Engine protections - Protezioni motore	CP047
Unlifted handlebars - Semimanubri bassi	SM50B
Top triple clamp "Street" - Piastra di sterzo superiore "Street"	PSY1
Top triple clamp "Race" - Piastra di sterzo superiore "Race"	PSY1R
Dashboard protection - Protezione strumentazione	DCP04
Brake lever - Leva freno	LB101
Clutch lever - Leva frizione	LC010
Full clutch lever - Leva frizione completa	LCF
Adjustable full clutch lever - Leva frizione completa regolabile	LCFR
Levers kit - Kit leve	KL231
Lever protection - Paraleva	LP RR
Carbon lever protection - Protezione leva in carbonio	LPLITE_R
Tank cap - Tappo serbatoio	FC110
Oil cap - Tappo olio	T007
8ml Oil tank - Serbatoio olio 8ml	0040
Chain adjuster - Tendicatena	CHAD11
Swing arms spools - Supporti cavalletto	0025
Swing arms spools "racing" - Supporti cavalletto "racing"	0027





DESCRIPTION - DESCRIZIONE

CODE - CODICE

Rearset - Pedane	Y013
Engine protections - Protezioni motore	CP025
Unlifted handlebars - Semimanubri bassi	SM50B
Lifted handlebars - Semimanubri rialzati	SM50
Top triple clamp "Street" - Piastra di sterzo superiore "Street"	PSY2
Top triple clamp "Race" - Piastra di sterzo superiore "Race"	PSY2R
Brake lever - Leva freno	LB100
Brake lever with remote adjuster - Leva freno con registro a sx	RALB100
Clutch lever - Leva frizione	LC010
Full clutch lever - Leva frizione completa	LCF
Adjustable full clutch lever - Leva frizione completa regolabile	LCFR
Levers kit - Kit leve	KL230
Lever protection - Paraleva	LPRR
Carbon lever protection - Protezione leva in carbonio	LPLITE_R
Tank cap - Tappo serbatoio	FC110
Oil cap - Tappo olio	T007
8ml Oil tank - Serbatoio olio 8ml	0040
Chain adjuster - Tendicatena	CHAD07
Swing arms spools - Supporti cavalletto	0025
Swing arms spools "racing" - Supporti cavalletto "racing"	0027
Gear spacer support - Supporto distanziale cambio	DC_037B

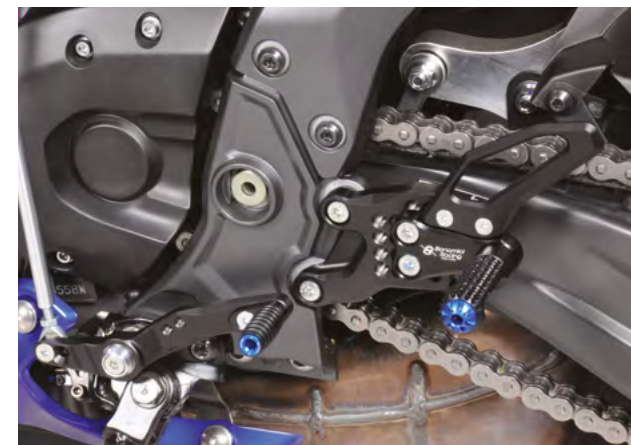
**DESCRIPTION - DESCRIZIONE****CODE - CODICE**

Rearsets - Pedane	Y015
Unlifted handlebars - Semimanubri bassi	SM50B
Top triple clamp "Street" - Piastra di sterzo superiore "Street"	PSY3
Top triple clamp "Race" - Piastra di sterzo superiore "Race"	PSY3R
Top triple clamp Nut - Dado piastra di sterzo superiore	DD3
Dashboard protection - Protezione strumentazione	DCP16
Brake lever - Leva freno It can only be mounted on Bonamici Racing handlebars Code SM50B Può essere montata solo sui semimanubri Bonamici Racing Codice SM50B	LB220
Brake lever with remote adjuster - Leva freno con registro a sx	RALB220
Clutch lever - Leva frizione	LC010
Full clutch lever - Leva frizione completa	LCF
Adjustable full clutch lever - Leva frizione completa regolabile	LCFR
Levers kit - Kit leve	KL340
Lever protection - Paraleva	LPRR
Carbon lever protection - Protezione leva in carbonio	LPLITE_R
Remote adjuster - Registro remoto	00BR
Racing Remote adjuster - Registro remoto "racing"	RRP_BR
Tank cap - Tappo serbatoio	FC110
Oil cap - Tappo olio	T007
8ml Oil tank - Serbatoio olio 8ml	0040
Swing arms spools - Supporti cavalletto	0025
Swing arms spools "racing" - Supporti cavalletto "racing"	0027





DESCRIPTION - DESCRIZIONE

CODE - CODICE

Rearset - Pedane	Y012
Engine protections - Protezioni motore	CP054
Lifted handlebars ('15/'18) - Semimanubri rialzati ('15/'18)	SM41
Lifted handlebars ('19/ >) - Semimanubri rialzati ('19/ >)	SM47
Dashboard protection * - Protezione strumentazione *	DCP07
Brake lever - Leva freno	LB170
Brake lever with remote adjuster - Leva freno con registro a sx	RALB170
Clutch lever - Leva frizione	LC150
Full clutch lever - Leva frizione completa	LCF
Adjustable full clutch lever - Leva frizione completa regolabile	LCFR
Levers kit - Kit leve	KL250
Lever protection - Paraleva	LPRR
Carbon lever protection - Protezione leva in carbonio	LPLITE_R
Tank cap - Tappo serbatoio	FC110
Oil cap - Tappo olio	T007
8ml Oil tank - Serbatoio olio 8ml	0040
Swing arms spools - Supporti cavalletto	0025
Swing arms spools "racing" - Supporti cavalletto "racing"	0027
Block mirror - Tappi specchio ('15/'18)	BM02



DESCRIPTION - DESCRIZIONE

CODE - CODICE

Rearset - Pedane	Y016
Brake lever - Leva freno	LB101
Clutch lever - Leva frizione	LC010
Full clutch lever - Leva frizione completa	LCF
Adjustable full clutch lever - Leva frizione completa regolabile	LCFR
Levers kit - Kit leve	KL231
Lever protection - Protezione leva	LPRR
Carbon lever protection - Protezione leva in carbonio	LPLITE_R
Tank cap - Tappo serbatoio	FC110
Oil cap - Tappo olio	T007
Swing arms spools - Supporti cavalletto	0025
Swing arms spools "racing" - Supporti cavalletto "racing"	0027



YAMAHA MT-10

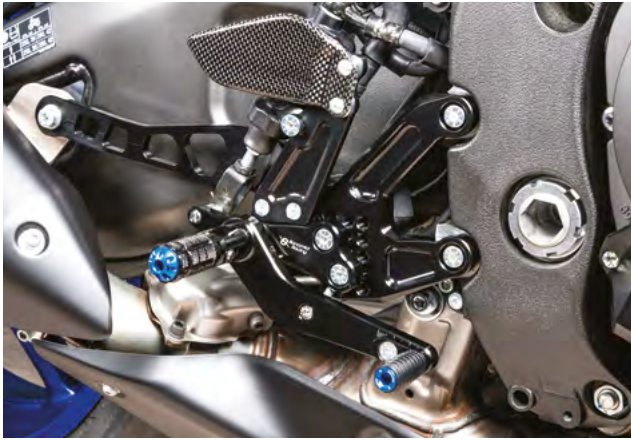

DESCRIPTION - DESCRIZIONE

CODE - CODICE

Rearset - Pedane	Y014
Engine protections - Protezioni motore	CP062
Levers kit - Kit leve	KL250
Lever protection - Paraleva	LPRR
Carbon lever protection - Protezione leva in carbonio	LPLITE_R
Tank cap - Tappo serbatoio	FC110
Oil cap - Tappo olio	T007
8ml Oil tank - Serbatoio olio 8ml	0040
Chain adjuster - Tendicatena	CHAD03
Swing arms spools - Supporti cavalletto	0025
Swing arms spools "racing" - Supporti cavalletto "racing"	0027

SALES CONDITIONS

All the prices on the brochures are expressed in euro and not comprehensive of VAT tax.

2D®, Aprilia®, BMW®, Braking®, Brembo®, Discacciati®, Ducati®, Honda®, I2M®, Kawasaki®, Ktm®, MV Agusta®, PT®, Suzuki®, Triumph®, Yamaha® are registered trademarks and used for reference.

All Bonamici Racing products are made for agonistic use only.

All Bonamici Racing products are 100% made in Italy, employing high quality materials.

Bonamici Racing reserves the right to change prices and sales conditions at any moment without further notice for commercial and technical purposes. This brochure provides information of general nature and does not represent a contractual binding.

All photos, images and informations displayed in this brochure are property of Bonamici Racing, total or partial reproduction is strictly forbidden.

All Bonamici Racing products have 2 years warranty.

WARNING:

Open the packaging with caution; installation must be operated by specialized personnel with appropriate equipment and follow any instructions contained in the packaging.

Before use make sure that all screws are tightened with care. Employ "Loctite" adhesive. Do not modify or tamper the parts for any reason. If you have difficulties in assembly, contact the company

CONDIZIONI GENERALI DI VENDITA

I prezzi dei prodotti presenti in catalogo sono in euro e non includono l'IVA.

2D®, Aprilia®, BMW®, Braking®, Brembo®, Discacciati®, Ducati®, Honda®, I2M®, Kawasaki®, Ktm®, MV Agusta®, PT®, Suzuki®, Triumph®, Yamaha® sono marchi di proprietà delle rispettive case ed usati solo a titolo descrittivo.

Tutti i prodotti Bonamici Racing sono da usare esclusivamente per le competizioni.

Tutti i prodotti Bonamici Racing sono realizzati al 100% in Italia con materiali di alta qualità.

Bonamici Racing si riserva il diritto di apportare modifiche costruttive ed ai prezzi dei prodotti presenti nel catalogo in qualunque momento e senza alcun preavviso. Questo catalogo fornisce informazioni di carattere generale e non costituisce documento contrattuale.

Tutte le foto, le immagini e le informazioni presenti in questo catalogo sono proprietà della Bonamici Racing, è vietato l'uso improprio.

Tutti i prodotti Bonamici Racing hanno 2 anni di garanzia.

AVVERTENZE:

Aprire la confezione con cura, il montaggio deve essere eseguito da personale specializzato con attrezzatura adeguata e seguire le eventuali istruzioni contenute nella confezione.

Prima dell'uso assicurarsi che tutte le viti siano tirate con cura. Usare la Loctite.

Non modificare o manomettere per alcun motivo le parti.

Se si riscontrano difficoltà nel montaggio contattare l'azienda.



Bonamici Racing S.r.l.

info@bonamiciracing.it
sales@bonamiciracing.it
www.bonamiciracing.it
tel. +39.0744.71.91.32

Headquarters - Sede operativa:

Strada Flaminia sn. civ.
Z.I. Molette di Otricoli
05030 Otricoli (TR)
Italy

Registered office - Sede amministrativa:

Vocabolo Verzieri , snc
02046 Magliano Sabina (RI)
Italy



www.bonamiciracing.it